

LEXUS
RX 450h



Hybrid
2010 Model
Emergency Response Guide



© 2009 Toyota Motor Corporation
All rights reserved. This document may not be
altered without the written permission of Toyota Motor Corporation.

10 Lexus RX 450h ERG REV – (06/05/09)

Foreword

In April 2005, Lexus released the Lexus RX 400h gasoline-electric hybrid vehicle in North America. To educate and assist emergency responders in the safe handling of Lexus RX 400h technology, Lexus published the 2006 Lexus RX 400h Emergency Response Guide.

With the release of the Lexus RX 450h in March 2009, a new 2010 Lexus RX 450h Emergency Response Guide was published for emergency responders. While many features from the RX 400h model are similar, emergency responders should recognize and understand the new, updated features of the RX 450h covered in this guide.

High voltage electricity powers the electric motors, generator, and inverter/converter. All other automotive electrical devices such as the headlights, radio, and gauges are powered from a separate 12 Volt auxiliary battery. Numerous safeguards have been designed into the RX 450h to help ensure the high voltage, approximately 288 Volt, Nickel Metal Hydride (NiMH) Hybrid Vehicle (HV) battery pack is kept safe and secure in an accident.

The RX 450h utilizes the following electrical systems:

- Maximum 650 Volts AC
- Nominal 288 Volts DC
- Maximum 46 Volts AC / DC
- Nominal 12 Volts DC

RX 450h Features:

- Complete model change with a new exterior and interior design.
- Adoption of the smart access system with push button start.
- A boost converter in the inverter/converter that boosts to 650 Volts the available voltage to the electric motors.
- A high voltage Hybrid Vehicle (HV) battery pack rated at 288 Volts.
- High voltage motor driven Air Conditioning (A/C) compressor rated at 288 Volts.
- An Electric Power Steering (EPS) assist motor rated at 46 Volts.
- Optional Active Stabilizer Suspension System motors rated at 46 Volts.

- A body electrical system rated at 12 Volts, negative chassis ground.
- Both Front Wheel Drive (FWD) and All Wheel Drive (AWD) models are available.
- Front and rear (AWD models only) 650 Volt electric motors.
- Supplemental Restraint System (SRS) – dual stage frontal airbags, front and rear seat mounted side airbags, side curtain airbags, front and rear seat belt pretensioners, and front knee airbags.

High voltage electrical safety remains an important factor in the emergency handling of the RX 450h Lexus Hybrid Drive. It is important to recognize and understand the disabling procedures and warnings throughout the guide.

Additional topics in the guide include:

- RX 450h identification.
- Major Lexus Hybrid Drive component locations and descriptions.
- Extrication, fire, recovery, and additional emergency response information.
- Roadside assistance information.

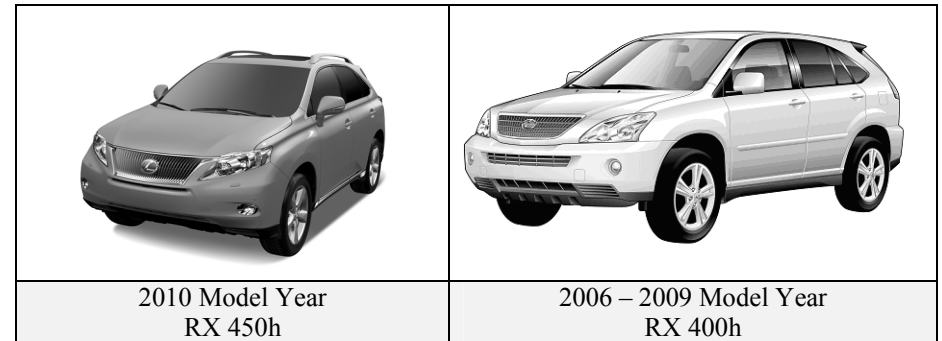

This guide is intended to assist emergency responders in the safe handling of a RX 450h vehicle during an incident.

NOTE:

Emergency Response Guides for Lexus hybrid vehicles may be viewed at <http://techinfo.lexus.com>.

Table of Contents	Page
About the RX 450h	1
RX 450h Identification	2
Lexus Hybrid Drive Component Locations & Descriptions	5
Smart Access System with Push Button Start	8
Lexus Hybrid Drive Operation	11
Hybrid Vehicle (HV) Battery Pack	12
46 Volt System	13
Low Voltage Battery	14
High Voltage Safety	15
SRS Airbags & Seat Belt Pretensioners	16
Emergency Response	18
Extrication	18
Fire	25
Overhaul	26
Recovering/Recycling of NiMH HV Battery Pack	26
Spills	27
First Aid	27
Submersion	28
Roadside Assistance	29

About the RX 450h

The RX 450h continues into its 2nd generation as a gasoline-electric hybrid vehicle. Lexus Hybrid Drive means that the vehicle contains a gasoline engine and electric motors for power. The two hybrid power sources are stored on board the vehicle:

1. Gasoline stored in the fuel tank for the gasoline engine.
2. Electricity stored in a high voltage Hybrid Vehicle (HV) battery pack for the electric motors.

The result of combining these two power sources is improved fuel economy and reduced emissions. The gasoline engine also powers an electric generator to recharge the battery pack; unlike a pure all electric vehicle, the RX 450h never needs to be recharged from an external electric power source.

Depending on the driving conditions one or both sources are used to power the vehicle. The following illustration demonstrates how the RX 450h operates in various driving modes.

- ❶ During light acceleration at low speeds, the vehicle is powered by the electric motors. The gasoline engine is shut off.
- ❷ During normal driving, the vehicle is powered mainly by the gasoline engine. The gasoline engine also powers the generator to recharge the battery pack.

- ❸ During full acceleration, such as climbing a hill, both the gasoline engine and the electric motor(s) power the vehicle.
- ❹ During deceleration, such as when braking, the vehicle regenerates the kinetic energy from the wheels to produce electricity that recharges the battery pack.
- ❺ While the vehicle is stopped, the gasoline engine and electric motors are off, however the vehicle remains on and operational.

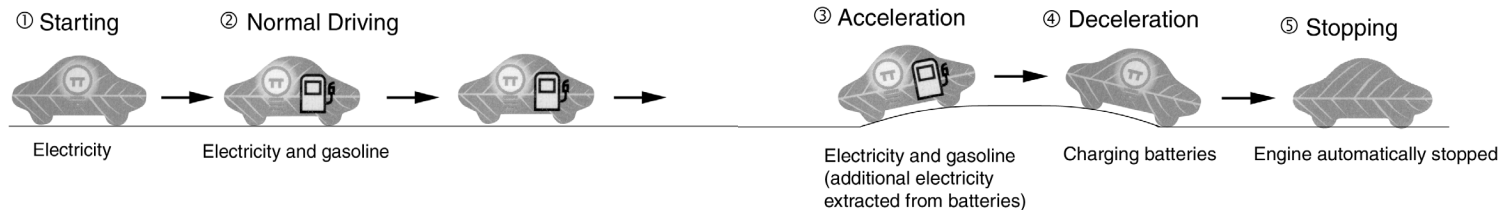

RX 450h Identification

In appearance, the 2010 model year RX 450h is nearly identical to the conventional, non-hybrid Lexus RX 350. The RX 450h is a 5-door SUV. Exterior, interior, and engine compartment illustrations are provided to assist in identification.

The alphanumeric 17 character Vehicle Identification Number (VIN) is provided in the front windshield cowl, on the floor under the passenger front seat (models for USA only) and on the driver door pillar.

Example VIN: JTJZB1BAF82020211(FWD Models)
JTJBC1BAF82020211(AWD Models)

A RX 450h is identified by the first 8 alphanumeric characters **JTJZB1BA** or **JTJBC1BA**.

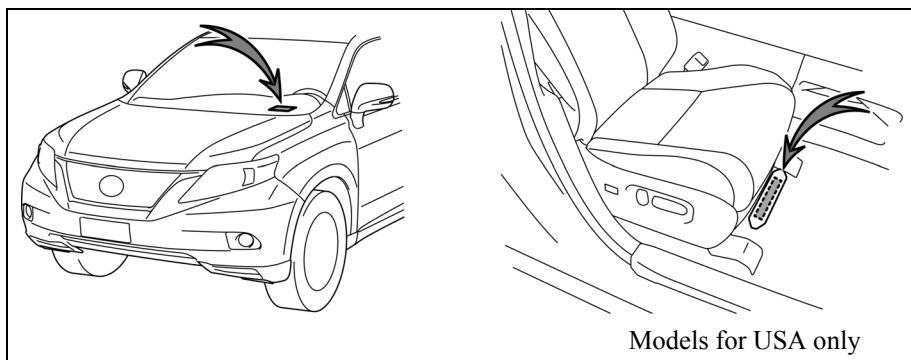

Driver Side Windshield and Passenger Side Floor

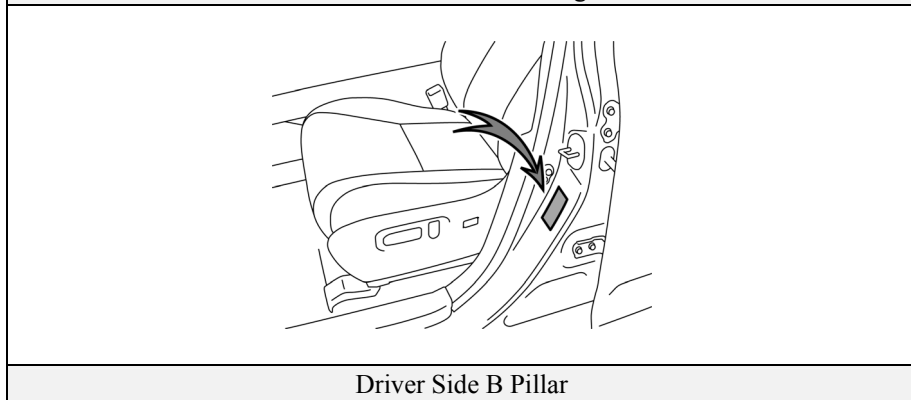

Exterior

- 1 **RX 450h** logo on the back door.
- 2 **HYBRID** logo on the rear door moldings.
- 3 Front bumper and grill that are unique to the hybrid model.



Exterior Driver Side View



Exterior Front and Rear View

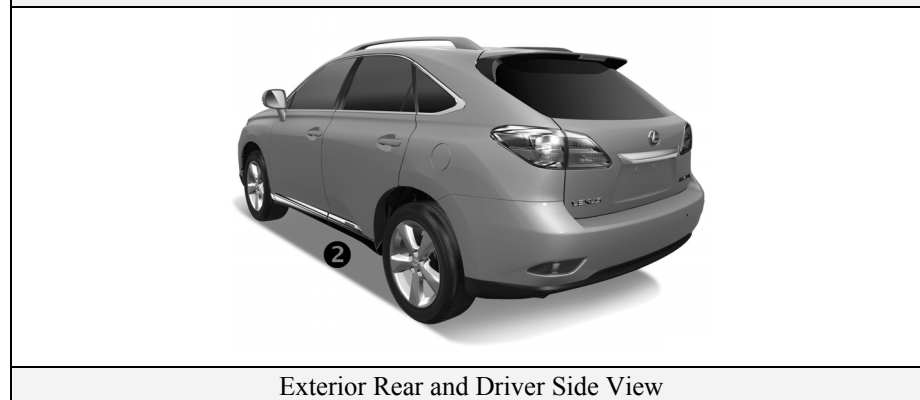

Exterior Rear and Driver Side View

RX 450h Identification (Continued)

Interior

- ④ The instrument cluster (speedometer, fuel gauge, warning lights) located in the dash behind the steering wheel, is different than the one on the conventional, non hybrid RX 350.

- ⑤ In place of a tachometer, a power meter is used to show power output.

NOTE:

If the vehicle is shut off, the instrument cluster gauges will be “blacked out”, not illuminated.

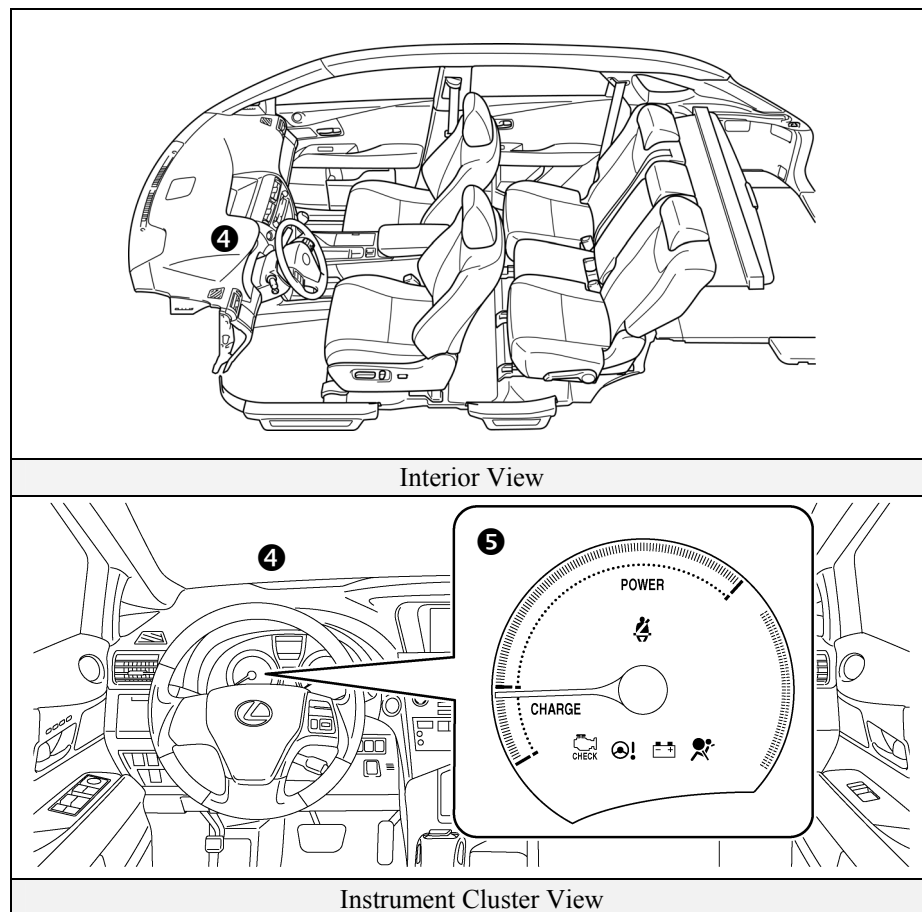

RX 450h Identification (Continued)

Engine Compartment

- ⑥ 3.5-liter aluminum alloy gasoline engine.
- ⑦ LEXUS HYBRID DRIVE logo on the plastic engine cover.

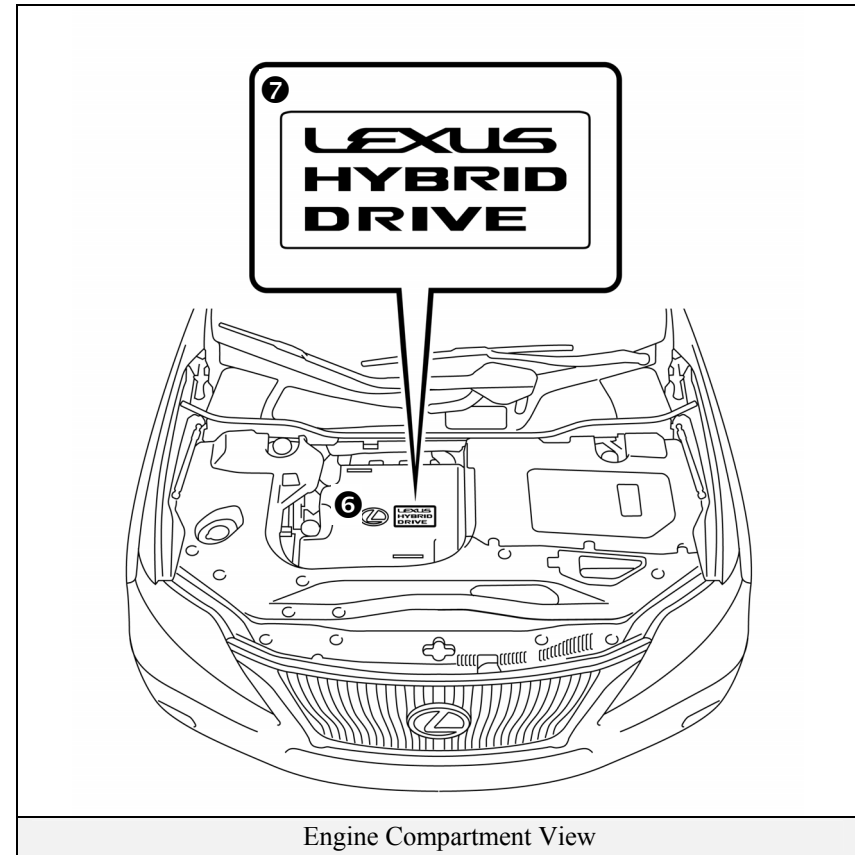

Lexus Hybrid Drive Component Locations & Descriptions

Component	Location	Description
12 Volt 1 Auxiliary Battery	Cargo Area	A lead-acid battery that supplies power to the low voltage devices.
Hybrid 2 Vehicle (HV) Battery Pack	Cabin Area, Mounted to Cross Member under Rear Seat	288 Volt Nickel Metal Hydride (NiMH) battery pack consisting of 30 low voltage (9.6 Volt) modules connected in series.
Power 3 Cables	Undercarriage and Engine Compartment	Orange colored power cables carry high voltage Direct Current (DC) between the HV battery pack, inverter/converter, and A/C compressor. These cables also carry 3-phase Alternating Current (AC) between the inverter/converter, electric motors, and generator.
Inverter/ Converter 4	Engine Compartment	Boosts and inverts the high voltage electricity from the HV battery pack to 3-phase AC electricity that drives the electric motors. The inverter/converter also converts AC electricity from the electric generator and electric motors (regenerative braking) to DC that recharges the HV battery pack.
Gasoline 5 Engine	Engine Compartment	Provides two functions: 1) Powers vehicle. 2) Powers generator to recharge the HV battery pack. The engine is started and stopped under control of the vehicle computer.
Front Electric 6 Motor	Engine Compartment	3-phase high voltage AC permanent magnet electric motor contained in the front transaxle. It is used to power the front wheels.
Electric 7 Generator	Engine Compartment	3-phase high voltage AC generator that is contained in the transaxle and recharges the HV battery pack.

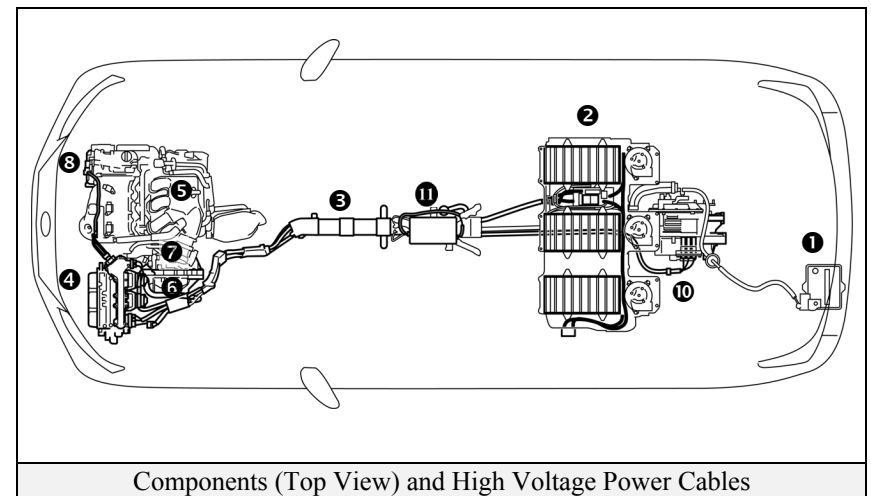
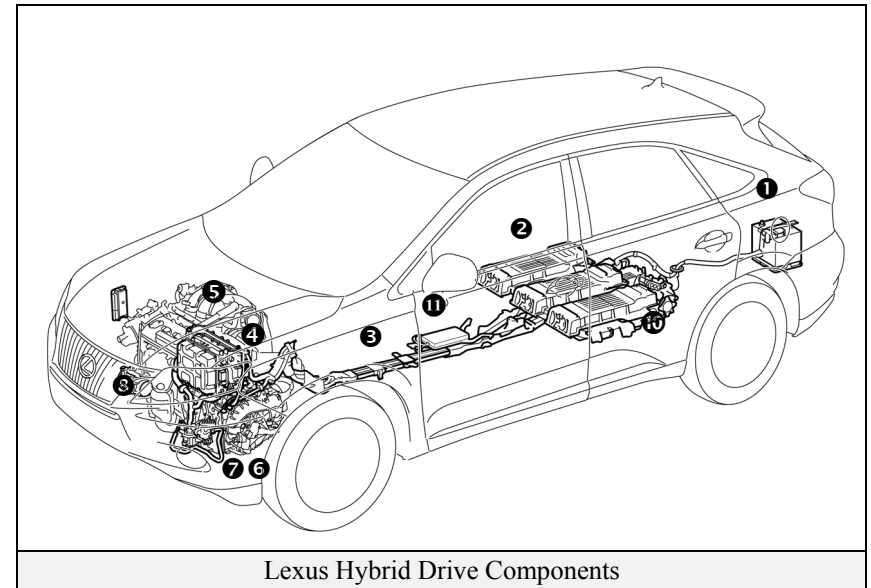

Lexus Hybrid Drive Component Locations & Descriptions (Continued)

Component	Location	Description
A/C Compressor (with Inverter) ⑧	Engine Compartment	3-phase high voltage AC electrically driven motor compressor.
Fuel Tank and Fuel Line ⑨	Undercarriage and Center	The fuel tank provides gasoline via a fuel line to the engine. The fuel line is routed under the center of vehicle.
Rear Electric Motor ⑩ (AWD models only)	Rear Sub-Frame	3-phase high voltage AC permanent magnet electric motor contained in the rear transaxle. It is used to power the rear wheels.
DC-DC Converter ⑪ for EPS and optional Active Stabilizer Suspension System	Under Center Console	Converts 288 Volts from the HV battery pack to 46 Volts for EPS and optional active stabilizer suspension system power.

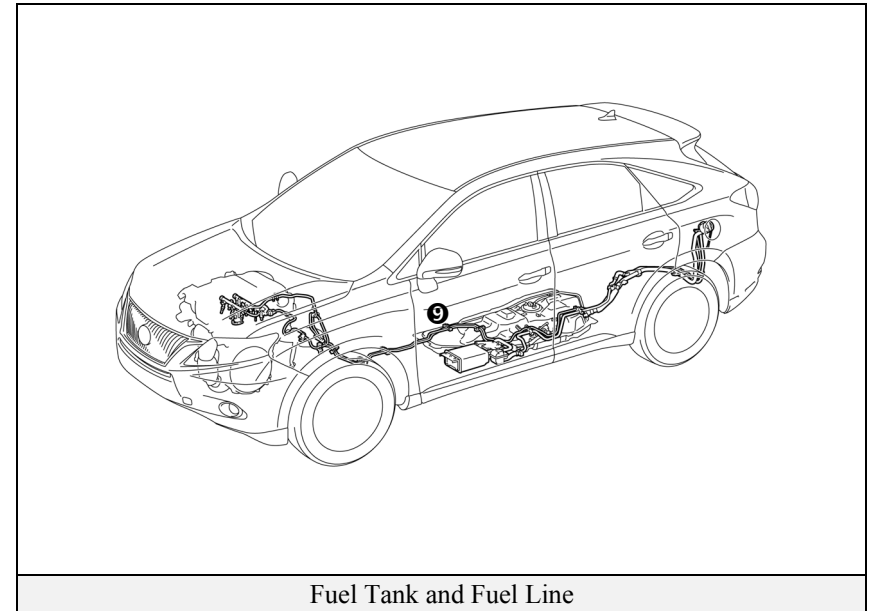

Lexus Hybrid Drive Component Locations & Descriptions (Continued)

Key Specifications:

Gasoline Engine: 245 hp (183 kW), 3.5-liter Aluminum Alloy Engine

Electric Motors

Front: 165 hp (123 kW), Permanent Magnet Motor

Rear: 67 hp (50 kW), Permanent Magnet Motor (AWD models only)

Transmission: Automatic Only (electrically controlled continuously variable transaxle)

HV Battery: 288 Volt Sealed NiMH-Battery

Curb Weight: 4,642 lbs/2,110 kg

Fuel Tank: 17.2 gals/65.0 liters

Fuel Economy

Ratings: 32/28 (City/Hwy) miles/US gal (for FWD models)
31/27 (City/Hwy) miles/US gal (for AWD models)
7.4/8.4 (City/Hwy) liters/100 km (for FWD models)
7.6/8.7 (City/Hwy) liters/100 km (for AWD models)

Frame Material: Steel Unibody

Body Material: Steel Panels

Seating Capacity: 5 passenger

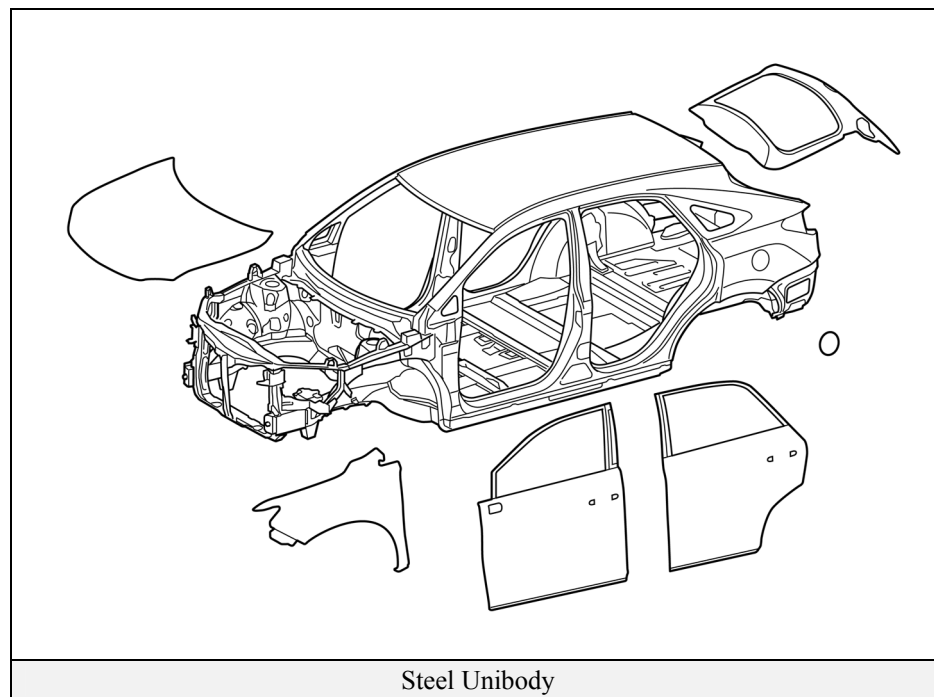

Smart Access System with Push Button Start

The RX 450h smart access system with push button start consists of a smart key transceiver that communicates bi-directionally, enabling the vehicle to recognize the smart key in proximity to the vehicle. Once recognized, the smart key will allow the user to lock and unlock the doors without pushing smart key buttons, and start the vehicle without inserting it into an ignition switch.

Smart key features:

- Passive (remote) function to lock/unlock the doors, open/close the optional power back door, and start the vehicle.
- Wireless transmitter buttons to lock/unlock all 5 doors.
- A wireless transmitter button to operate the optional power back door opener.
- Hidden metal cut key to lock/unlock the doors and glove box.

The RX 450h is equipped with two types of smart keys:

- Smart key (fob)
- Card smart key

The card smart key is designed to be stored in a wallet and has all the same functions as the smart key (fob), except push buttons.

Door (Lock/Unlock)

There are several methods available to lock/unlock the doors.

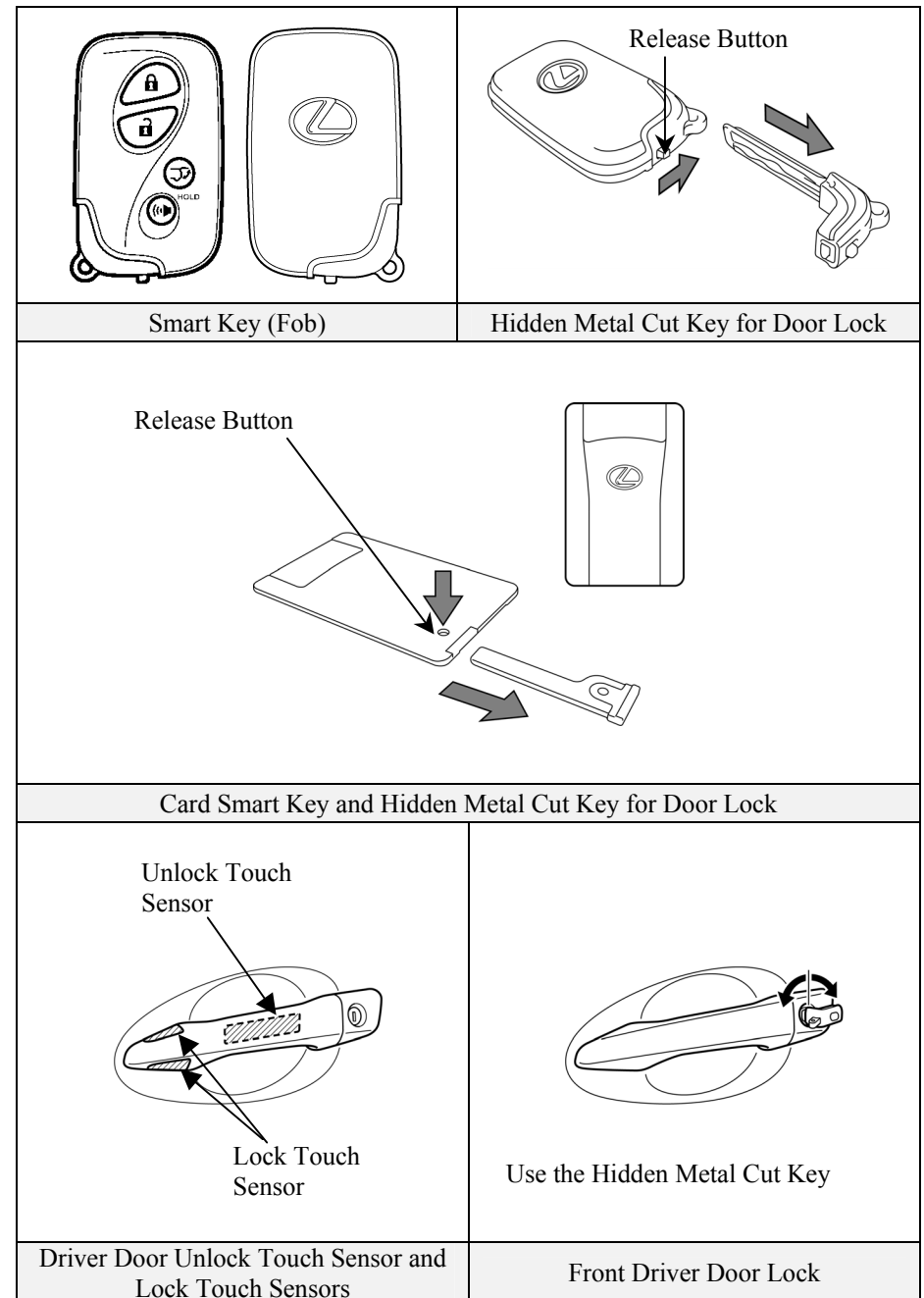

- Pushing the smart key lock button will lock all doors including the back door. Pushing the smart key unlock button once unlocks the driver door, twice unlocks all doors.
- Touching the sensor on the backside of the driver door exterior handle, with the smart key in proximity to the vehicle, unlocks the driver door. Touching the sensor on the backside of the front passenger door exterior handle, with the smart key in proximity to the vehicle, unlocks all doors. Touching the lock sensor on either front door, or the lock button for the back door will lock all doors.
- Inserting the hidden metal cut key in the driver door lock and turning clockwise once unlocks the driver door, twice unlocks all doors. To lock all doors turn the key counter clockwise once. Only the driver door contains an exterior door lock for the metal cut key.



Smart Access System with Push Button Start (Continued)

Back Door (Lock/Unlock)

Using the following methods will lock/unlock the back door.

- Pushing  on the wireless smart key locks all doors, including the back door.
- Pushing the back door lock button (see illustration) will lock all doors, including the back door.
- Pushing  on the wireless smart key twice unlocks all doors, including the back door.
- Touching the back door opener switch (see illustration) with the smart key in proximity to the back door will unlock/open the back door.

Optional Power Back Door (Open/Close)

Various methods are available to open/close the optional power back door.

- Pushing and holding  on the wireless smart key will open/close the optional power back door.
- Pushing the power back door switch on the instrument panel will open/close the power back door.
- Pushing the power back door closer switch (see illustration) located on the bottom of the door will close the power door.

NOTE:

If the power back door cancel switch is activated the power back door will not function.

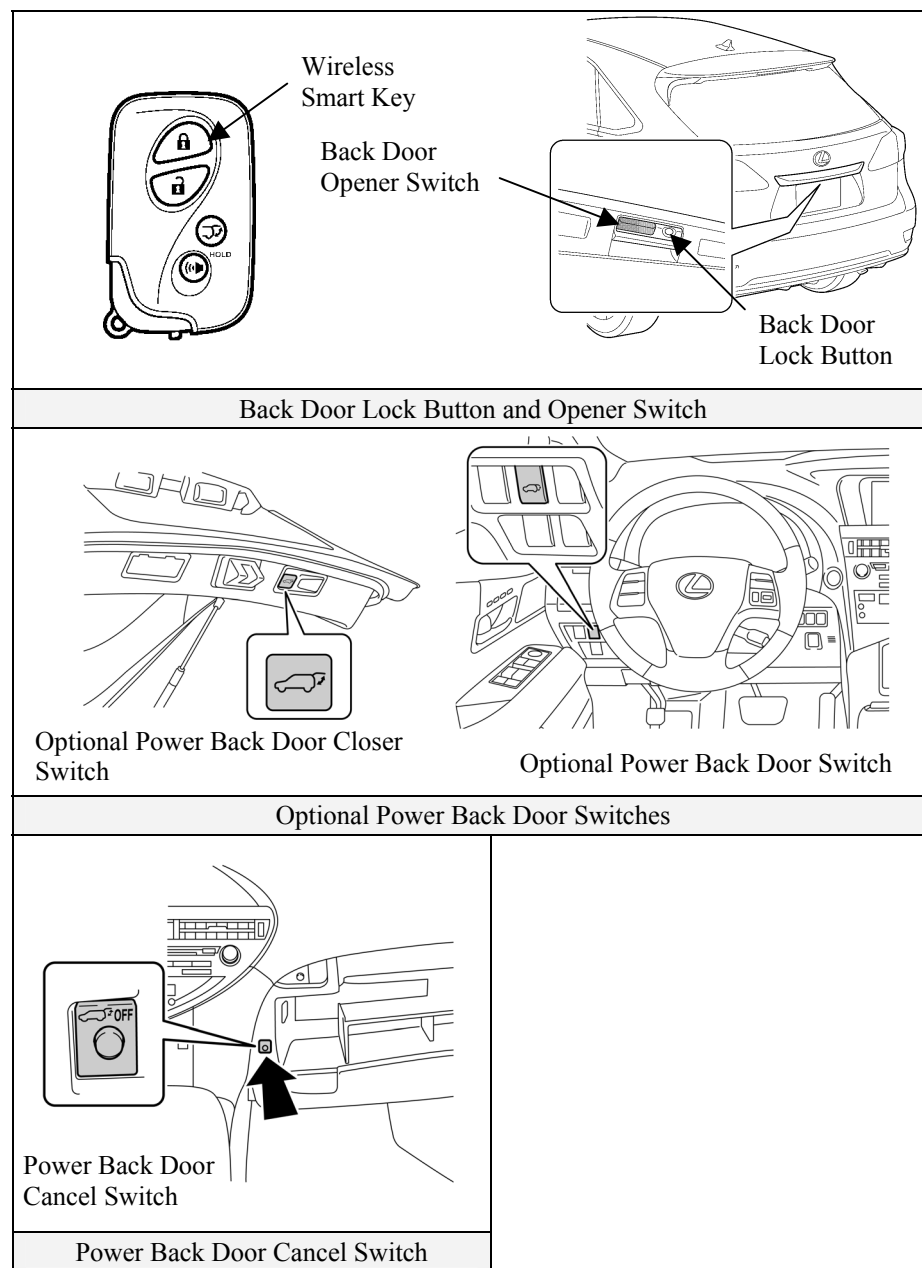

Smart Access System with Push Button Start (Continued)

Vehicle Starting/Stopping

The smart key has replaced the conventional metal cut key, and the power button with an integral status indicator light has replaced the ignition switch. The smart key only needs to be in proximity to the vehicle to allow the system to function.

- With the brake pedal released, the first push of the power button operates the accessory mode, the second push operates the ignition-on mode, and the third push turns the ignition off again.

Ignition Mode Sequence (brake pedal released):

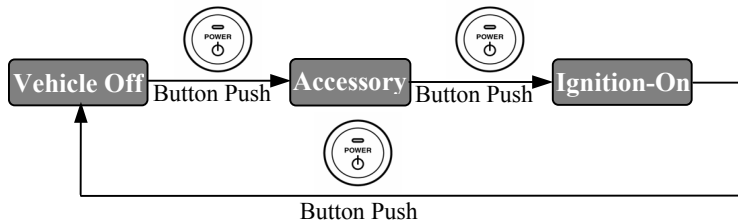

- Starting the vehicle takes priority over all other ignition modes and is accomplished by depressing the brake pedal and pushing the power button once. To verify the vehicle has started, check that the power button status indicator light is off and the **READY** light is illuminated in the instrument cluster.
- If the internal smart key battery is dead, use the following method to start the vehicle.
 - Touch the Lexus emblem side of the smart key to the power button.
 - Within the 5 seconds after the buzzer sounds, push the power button with the brake pedal depressed (the **READY** light will illuminate).
- Once the vehicle has started and is on and operational (**READY-ON**), the vehicle is shut off by bringing the vehicle to a complete stop, placing the shift lever in **Park**, and then depressing the power button once.
- To shut off the vehicle before coming to a stop in an emergency, push and hold down the power button for more than 3 seconds. This procedure may be useful at an accident scene in which the **READY** indicator is on, the shift lever cannot be placed into **Park**, and the drive wheels remain in motion.

Ignition Mode	Power Button Indicator Light
Off	Off
Accessory	Amber
Ignition-On	Amber
Brake Pedal Depressed	Green
Vehicle Started (READY-ON)	Off
Malfunction	Blinking Amber

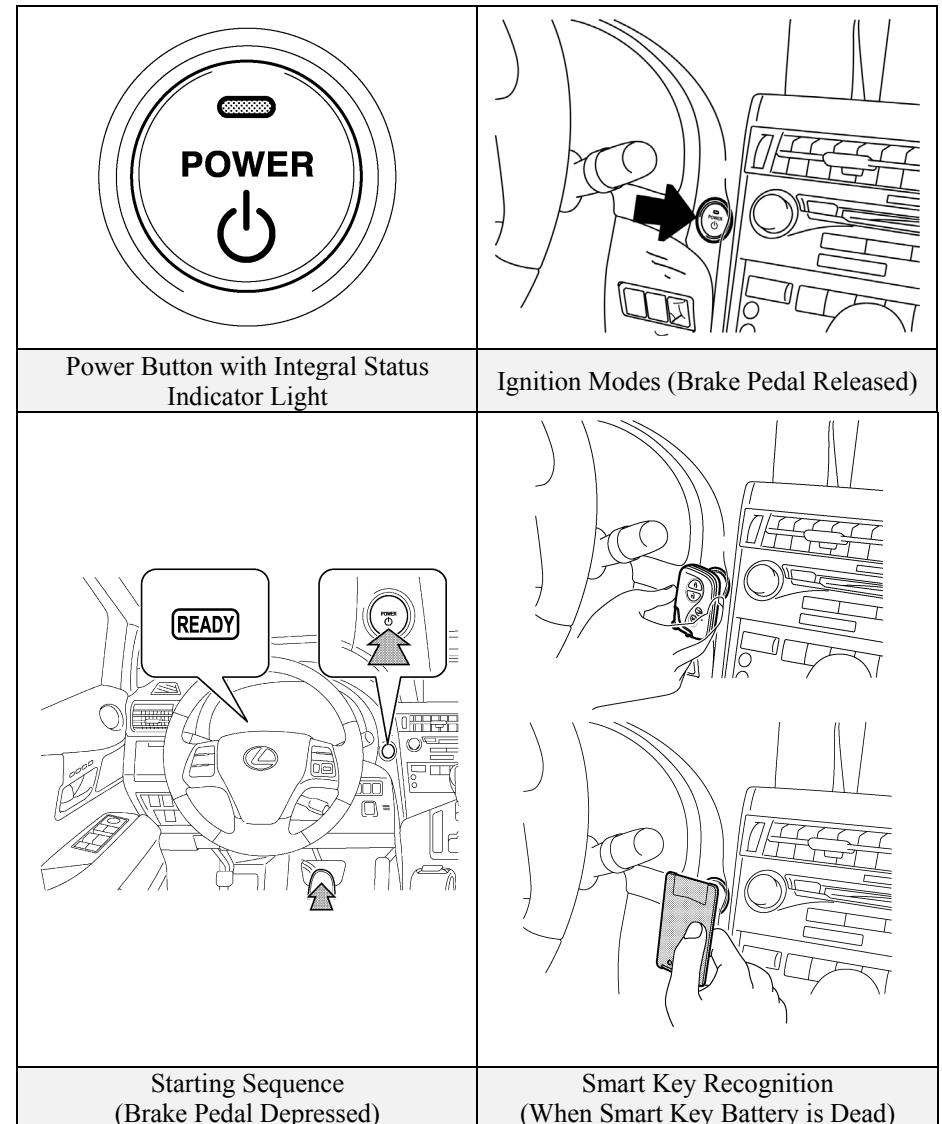

Power Button with Integral Status Indicator Light

Ignition Modes (Brake Pedal Released)

Starting Sequence (Brake Pedal Depressed)

Smart Key Recognition (When Smart Key Battery is Dead)

Lexus Hybrid Drive Operation

Once the **READY** indicator is illuminated in the instrument cluster, the vehicle may be driven. However, the gasoline engine does not idle like a typical automobile and will start and stop automatically. It is important to recognize and understand the **READY** indicator provided in the instrument cluster. When lit, it informs the driver that the vehicle is on and operational even though the gasoline engine may be off and the engine compartment is silent.

Vehicle Operation

- With the RX 450h, the gasoline engine may stop and start at any time while the **READY** indicator is on.
- Never assume that the vehicle is shut off just because the engine is off. Always look for the **READY** indicator status. The vehicle is shut off when the **READY** indicator is off.
- The vehicle may be powered by:
 1. The electric motors only.
 2. The gasoline engine only.
 3. A combination of both the electric motors and the gasoline engine.
- The vehicle computer determines the mode in which the vehicle operates in order to improve fuel economy and reduce emissions. Three new features on the 2010 RX 450h are HYBRID SNOW mode, EV (Electric Vehicle) mode and ECO (Economy) mode: These modes can be selected using the multi-information Menu and ENTER switches on the steering wheel and the Multi-information Display. The selected mode will be displayed by an indicator light.
 1. **HYBRID SNOW Mode:** When activated, this mode helps enhance control stability due to accelerator pedal operation. This mode moderates the amount of system power output in relation to the amount of accelerator operation. On AWD models, if the front wheels slip, the assist power of the rear electric motor is optimized, enhancing start-off stability.
 2. **EV Mode:** When activated, and certain conditions have been met, the vehicle operates with the electric motor(s) powered by the HV battery.

3. **ECO Mode:** When activated, this mode helps enhance fuel economy on trips that involve frequent braking and acceleration.

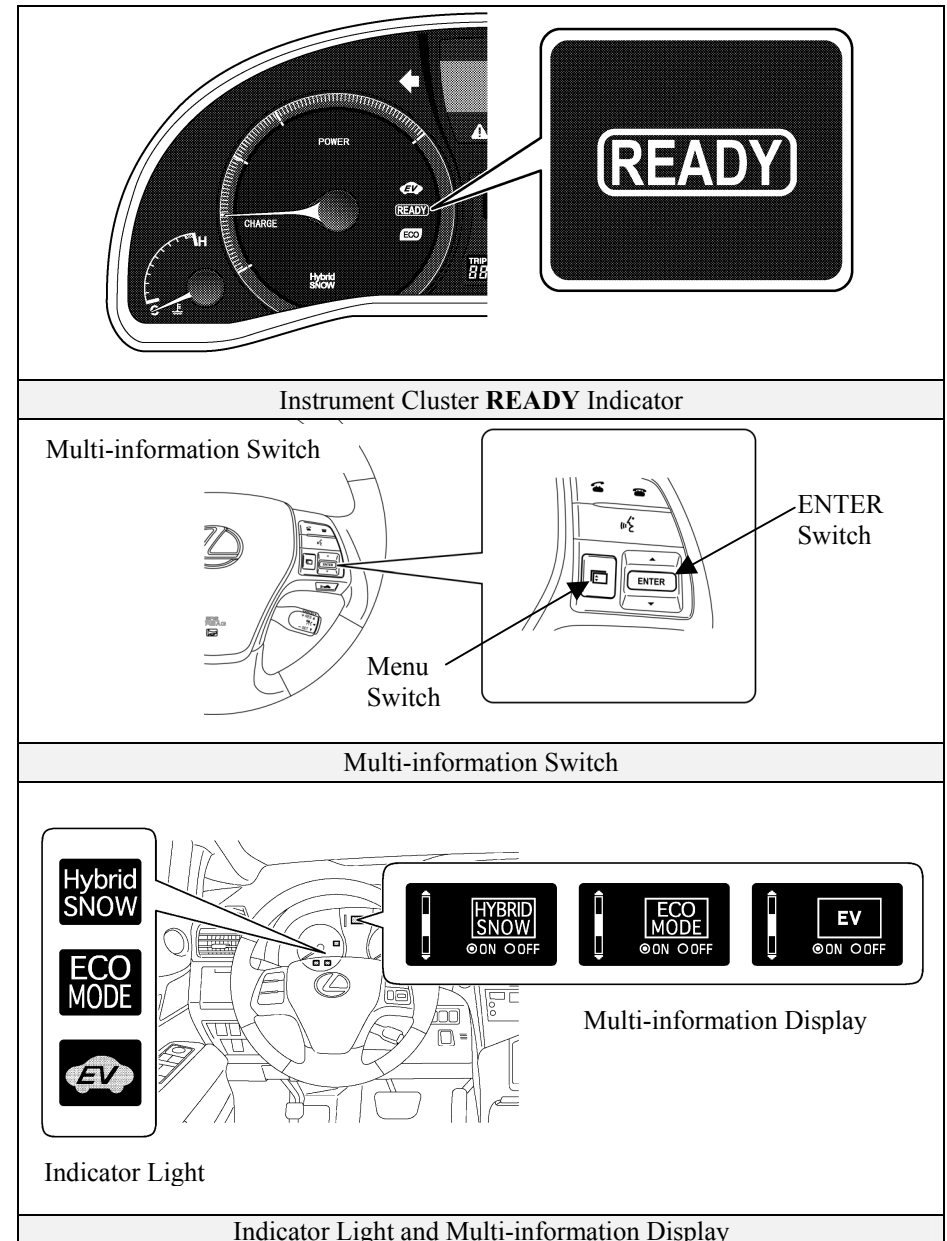

Hybrid Vehicle (HV) Battery Pack

The RX 450h features a high voltage Hybrid Vehicle (HV) battery pack that contains sealed Nickel Metal Hydride (NiMH) battery modules.

HV Battery Pack

- The HV battery pack is enclosed in a metal case and is rigidly mounted to the cabin area floor pan cross member under the rear seat. The metal case is isolated from high voltage and concealed by carpet in the cabin area.
- The HV battery pack consists of 30 low voltage (9.6 Volt) NiMH battery modules connected in series to produce approximately 288 Volts. Each NiMH battery module is non-spillable and in a sealed case.
- The electrolyte used in the NiMH battery module is an alkaline mixture of potassium and sodium hydroxide. The electrolyte is absorbed into the battery cell plates and will not normally leak, even in a collision.
- In the unlikely event that the battery pack is overcharged, the modules vent gases directly outside the vehicle through a vent hose.

HV Battery Pack	
Battery pack voltage	288 V
Number of NiMH battery modules in the pack	30
NiMH battery module voltage	9.6 V
NiMH battery module dimensions	1 x 15 x 3.3 in (18.5 x 382 x 86 mm)
NiMH module weight	3.3 lbs (1.5 kg)
NiMH battery pack dimensions	25 x 43 x 7 in (630 x 1080 x 180 mm)
NiMH battery pack weight	152.1 lbs (69 kg)

Components Powered by the HV Battery Pack

- Front Electric Motor
- Inverter/Converter
- A/C Compressor
- DC-DC Converter for EPS and Active Stabilizer Suspension System
- Rear Electric Motor
- Power Cables
- Electric Generator

HV Battery Pack Recycling

- The HV battery pack is recyclable. Contact the nearest Lexus dealer or:

United States: (800) 255-3987, Canada: (800) 265-3987

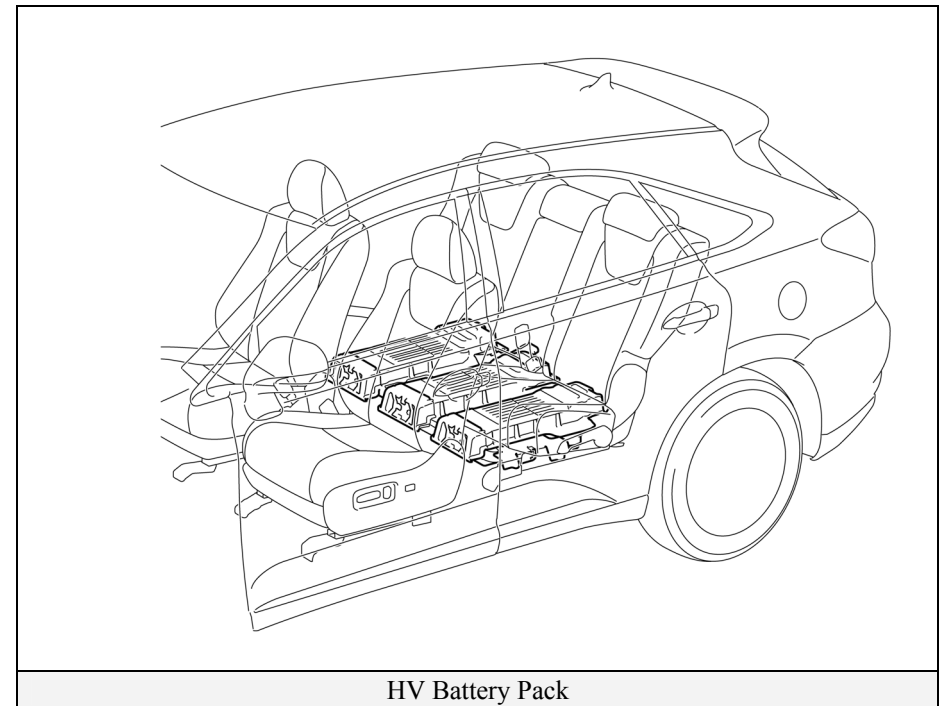

46 Volt System

The RX450h is equipped with a 46 Volt electrical system that powers the Electric Power Steering (EPS) assist motor and the optional Active Stabilizer Suspension System motors for the front and rear stabilizer bars.

- The 46 Volt electrical system does not contain a storage battery. It is powered by converting high voltage battery power at the DC-DC converter located under the center console.
- The 46 Volt wires are routed from the DC-DC converter to the EPS ECU near the steering column under the dash and the optional active stabilizer ECUs outside the cabin and under the cargo area.
- If the HV battery pack malfunctions, backup power is provided to the EPS motor by boosting power from the 12 Volt electrical system.

NOTE:

46 Volts has a higher arc potential than 12 Volts.

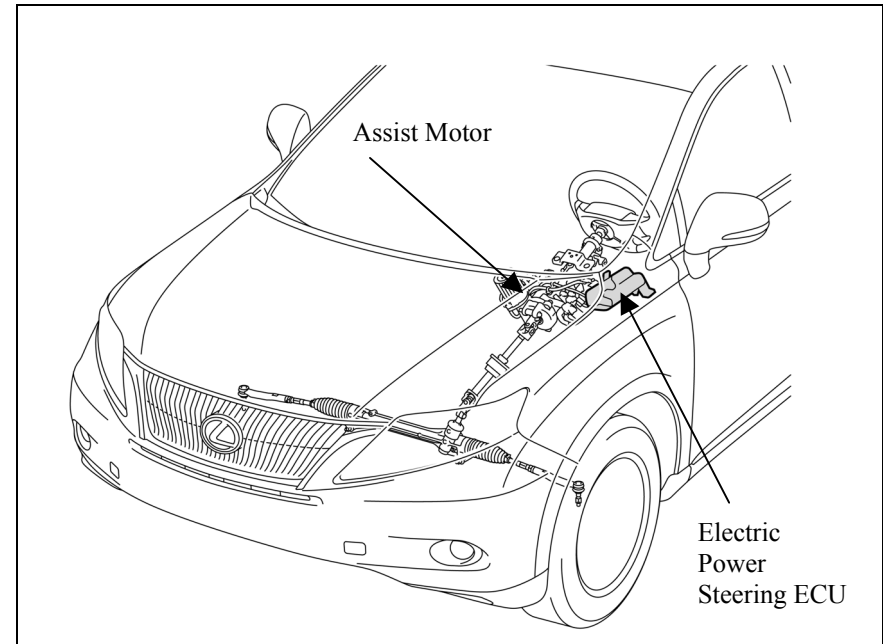

46 Volt Electric Power Steering System

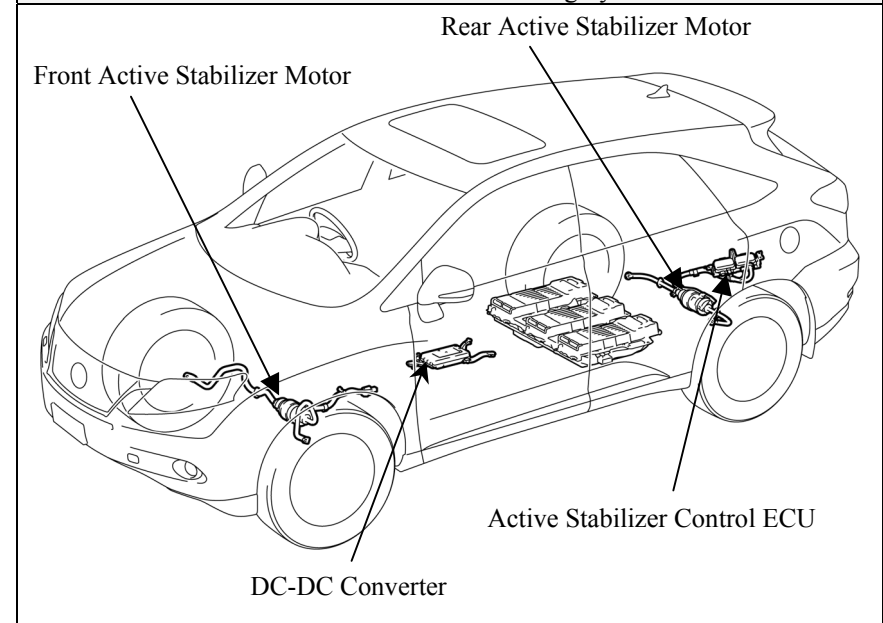

Optional 46 Volt Active Stabilizer Suspension System

Low Voltage Battery

Auxiliary Battery

- The RX 450h contains a sealed lead-acid 12 Volt battery. The 12 Volt auxiliary battery powers the vehicle's electrical system similar to a conventional vehicle. As with conventional vehicles, the negative terminal of the auxiliary battery is grounded to the metal chassis of the vehicle.
- The auxiliary battery is located in the cargo area. It is concealed by a battery cover on the driver side of the vehicle.

NOTE:

An under hood label shows the location of the HV battery (traction battery) and 12 Volt auxiliary battery.

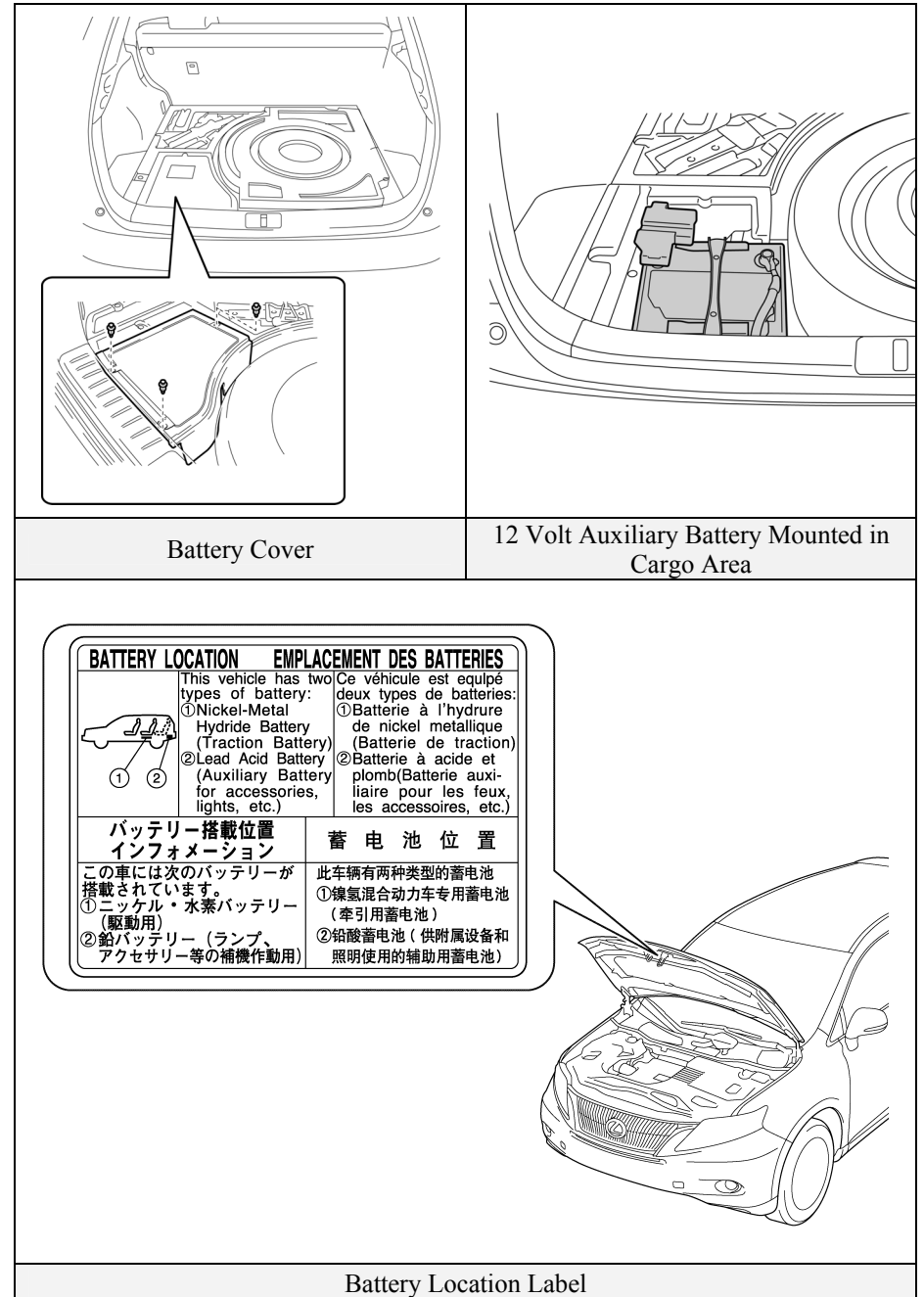

Battery Location Label

High Voltage Safety

The HV battery pack powers the high voltage electrical system with DC electricity. Positive and negative orange colored high voltage power cables are routed from the battery pack, under the vehicle floor pan, to the inverter/converter. The inverter/converter contains a circuit that boosts the HV battery voltage from 288 to 650 Volts DC. The inverter/converter creates 3-phase AC to power the motors. Power cables are routed from the inverter/converter to each high voltage motor (front and rear electric motors, electric generator, and A/C compressor). The following systems are intended to help keep occupants in the vehicle and emergency responders safe from high voltage electricity:

High Voltage Safety System

- A high voltage fuse ❶ provides short circuit protection in the HV battery pack.
- Positive and negative high voltage power cables ❷ connected to the HV battery pack are controlled by 12 Volt normally open relays ❸. When the vehicle is shut off, the relays stop electrical flow from leaving the HV battery pack.

⚠️ WARNING:

The high voltage system may remain powered for up to 10 minutes after the vehicle is shut off or disabled. To prevent serious injury or death from severe burns or electric shock, avoid touching, cutting, or breaching any orange high voltage power cable or high voltage component.

- Both positive and negative power cables ❷ are insulated from the metal vehicle body. High voltage electricity flows through these cables and not the metal vehicle body. The metal vehicle body is safe to touch because it is insulated from the high voltage components.
- A ground fault monitor ❹ continuously monitors for high voltage leakage to the metal chassis while the vehicle is running. If a malfunction is detected, the hybrid vehicle computer ❹ will illuminate the master warning light ⚠️ in the instrument cluster and indicate “Check Hybrid System” on the multi-information display.

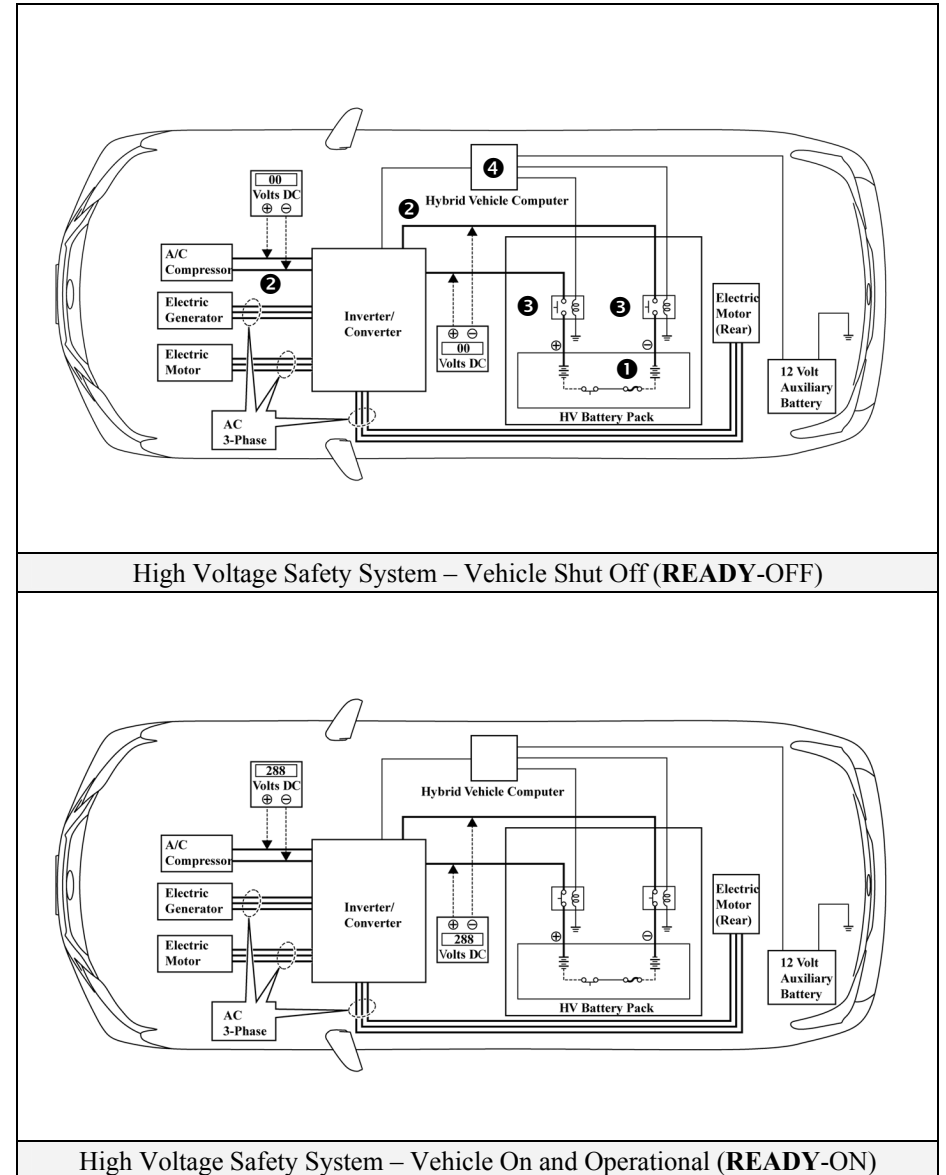

SRS Airbags & Seat Belt Pretensioners

Standard Equipment

- Electronic frontal impact sensors (2) are mounted in the engine compartment ① as illustrated.
- Front seat belt pretensioners are mounted near the base of the B-pillars ②.
- Rear seat belt pretensioners are mounted in the C-pillars. ③
- A frontal dual stage driver airbag ④ is mounted in the steering wheel hub.
- A frontal twin-chamber shaped dual stage passenger airbag ⑤ is integrated into the dashboard and deploys through the top of the dashboard.
- The SRS computer ⑥, which contains an impact sensor, is mounted on the floor pan underneath the instrument panel, forward of the shift lever.
- Front electronic side impact sensors (2) are mounted near the base of the B-pillars. ⑦
- Rear electronic side impact sensors (2) are mounted near the base of the C-pillars. ⑧
- Front seat side airbags ⑨ are mounted in the front seatbacks.
- Side curtain airbags ⑩ are mounted along the outer edge inside the roof rails.
- Front knee airbags ⑪ are mounted on the driver side and passenger side lower portion of the dash.
- Rear seat side airbags ⑫ are mounted in the rear seatbacks.
- Active (mechanical non-pyrotechnic) front seat headrests (see description on page 24).

Optional Equipment

- The optional pre-collision safety system contains a radar sensory system, occupant seat sensor, and an electric motor-pyrotechnic pretensioner system. During a pre-collision event, an electric motor in the pretensioners retracts the front seat belts. When conditions stabilize the electric motor will reverse itself. When the airbags deploy, the pyrotechnic pretensioners function normally.

WARNING:

The SRS may remain powered for up to 90 seconds after the vehicle is shut off or disabled. To prevent serious injury or death from unintentional SRS deployment, avoid breaching the SRS components.

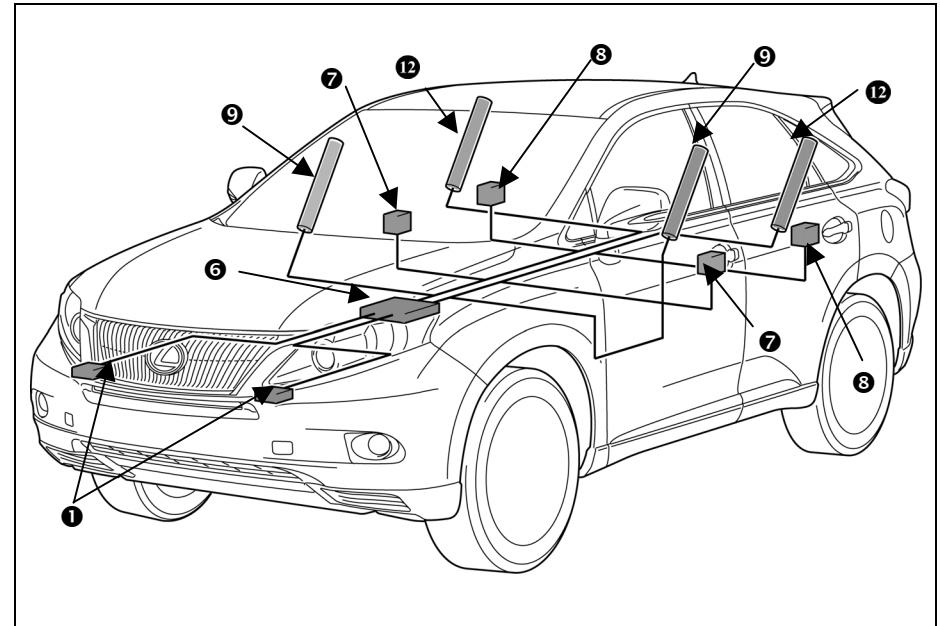

Electronic Impact Sensors and Side Airbags

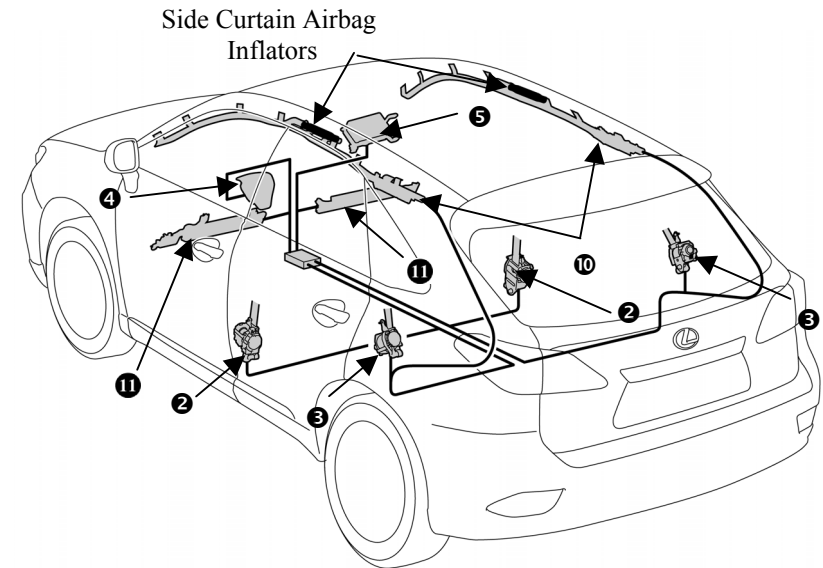

Standard Frontal Airbags, Seat Belt Pretensioners, Knee Airbag, Side Curtain Airbags

SRS Airbags & Seat Belt Pretensioners (Continued)

NOTE:

The front seatback mounted side airbags and the side curtain airbags may deploy independently of each other.

The knee airbag deploys simultaneously with the frontal airbags.

The RX 450h is equipped with a standard front passenger occupant classification system that may prohibit the deployment of the front passenger frontal airbag, knee airbag, seatback mounted side airbag, and seat belt pretensioner. If the passenger occupant classification system prohibits deployment during an SRS event, the passenger SRS will not re-arm nor deploy.

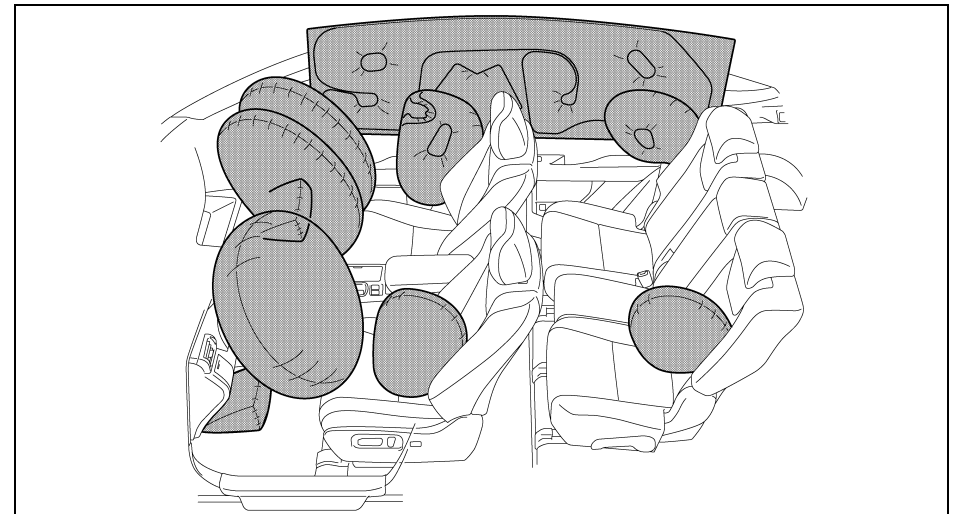
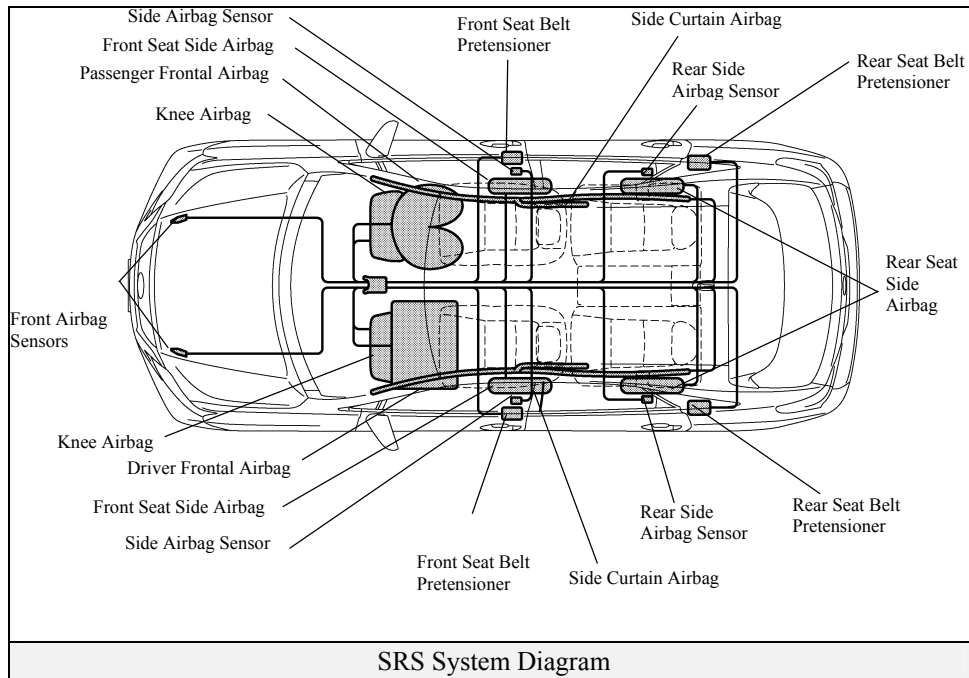

Frontal, Knee, Front and Rear Seatback Mounted Side, Side Curtain Airbags.

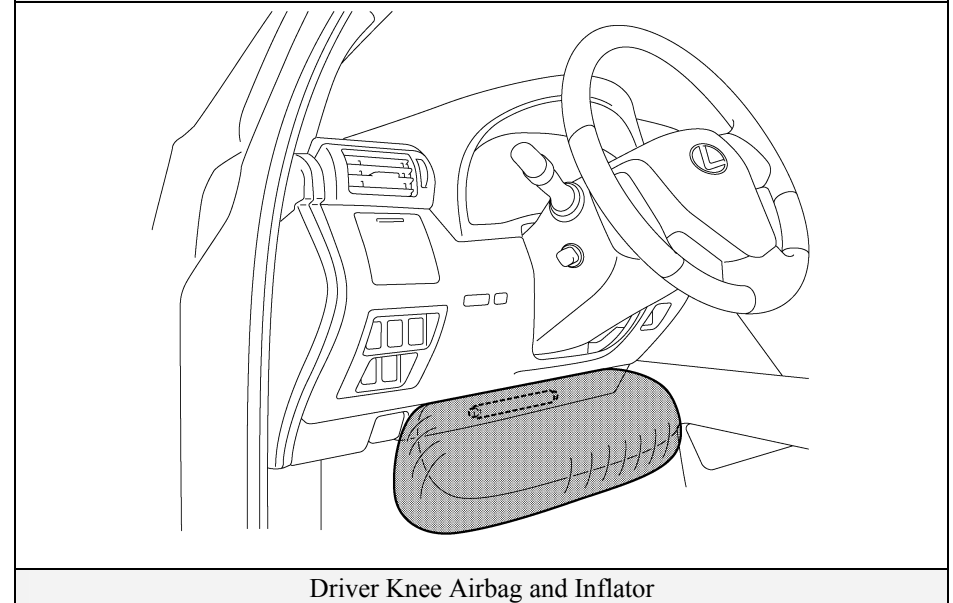

Emergency Response

On arrival, emergency responders should follow their standard operating procedures for vehicle incidents. Emergencies involving the RX 450h may be handled like other automobiles except as noted in these guidelines for Extrication, Fire, Overhaul, Recovery, Spills, First Aid, and Submersion.

WARNING:

- *Never assume the RX 450h is shut off simply because it is silent.*
- *Always observe the instrument cluster for the **READY** indicator status to verify whether the vehicle is on or shut off. The vehicle is shut off when the **READY** indicator is off.*
- *Failure to shut off the vehicle before emergency response procedures are performed may result in serious injury or death from the unintentional deployment of the SRS or severe burns and electric shock from the high voltage electrical system.*

Extrication

- **Immobilize Vehicle**
Chock wheels and set the parking brake.
Move the shift lever to the **Park** position.
- **Disable Vehicle**
Performing either of the following two procedures will shut the vehicle off and disable the HV battery pack, SRS, and gasoline fuel pump.

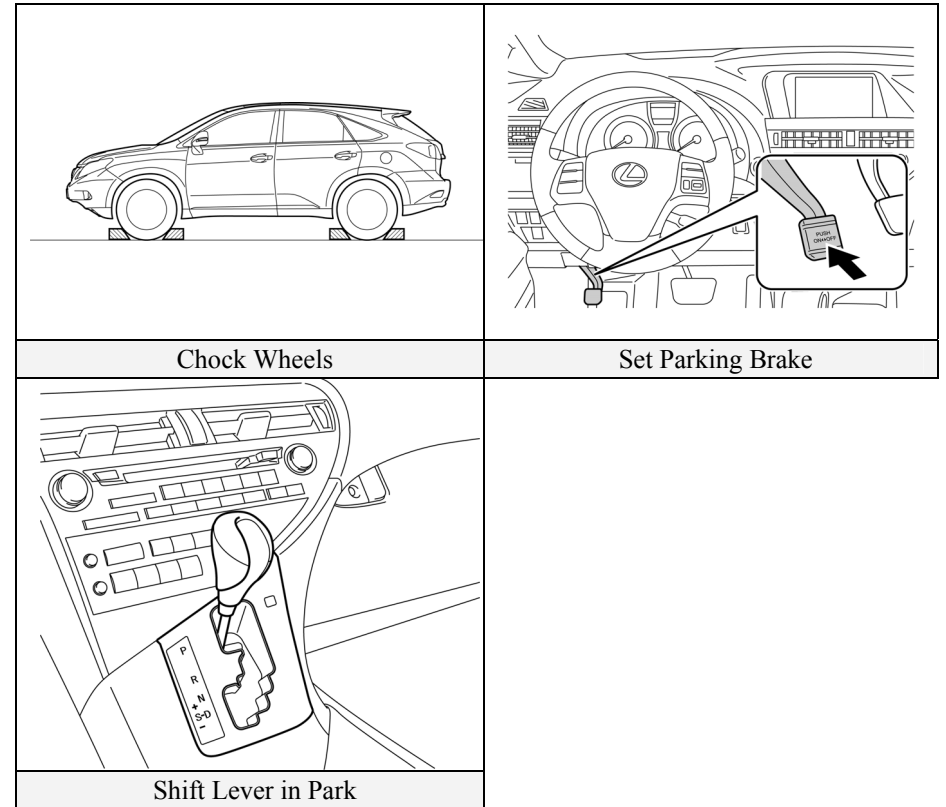

Emergency Response (Continued)

Extrication (Continued)

Procedure #1

1. Confirm the status of the **READY** indicator in the instrument cluster.
2. If the **READY** indicator is illuminated, the vehicle is on and operational. Shut off the vehicle by pushing the power button once.
3. The vehicle is already shut off if the instrument cluster lights and the **READY** indicator are not illuminated. Do **not** push the power button because the vehicle may start.
4. If the smart key is easily accessible, keep it at least 16 feet (5 meters) away from the vehicle.
5. If the smart key cannot be found, disconnect the 12 Volt auxiliary battery under the cover in the cargo area to prevent accidental restarting of the vehicle.

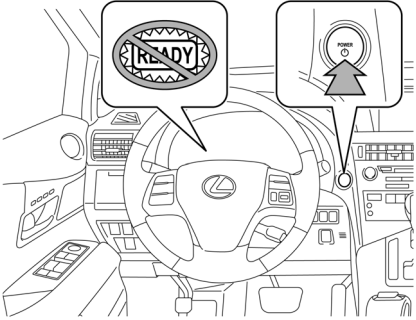
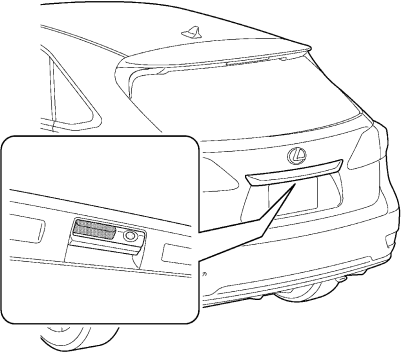
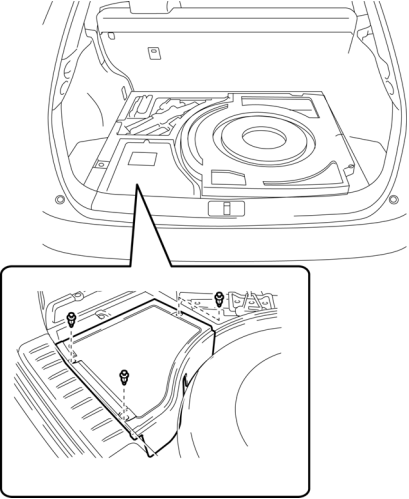
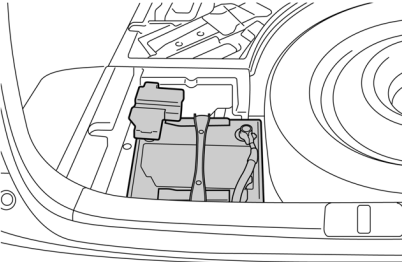
	
Shut Off Vehicle (READY-OFF)	Electric Back Door Opener Switch
	
Remove Auxiliary Battery Cover	12 Volt Auxiliary Battery in Cargo Area

Emergency Response (Continued)

Extrication (Continued)

Procedure #2 (Alternate if power button is inaccessible)

1. Open the hood and remove the engine room cover.
2. Remove the fuse box cover.
3. Remove the **IG2 MAIN** fuse (30A green colored) in the engine compartment fuse box (refer to illustration). If the correct fuse cannot be recognized, pull all fuses in the fuse box.
4. Disconnect the 12 Volt auxiliary battery under the cover in the cargo area.

NOTE:

Before disconnecting the 12 Volt auxiliary battery, if necessary, reposition the power seats, lower the windows, unlock the doors, open the back door and the fuel door as required. A manual fuel door release is located behind a panel in the driver side of the cargo area (see the illustration in the Roadside Assistance section on page 30). Once the 12 Volt auxiliary battery is disconnected, power controls will not operate.

WARNING:

- *The high voltage system may remain powered for up to 10 minutes after the vehicle is shut off or disabled. To prevent serious injury or death from severe burns or electric shock, avoid touching, cutting, or breaching any orange high voltage power cable or high voltage component.*
- *The SRS may remain powered for up to 90 seconds after the vehicle is shut off or disabled. To prevent serious injury or death from unintentional SRS deployment, avoid breaching the SRS components.*
- *If none of the disabling procedures can be performed, proceed with caution as there is no assurance that the high voltage electrical system, SRS, or fuel pump are disabled.*

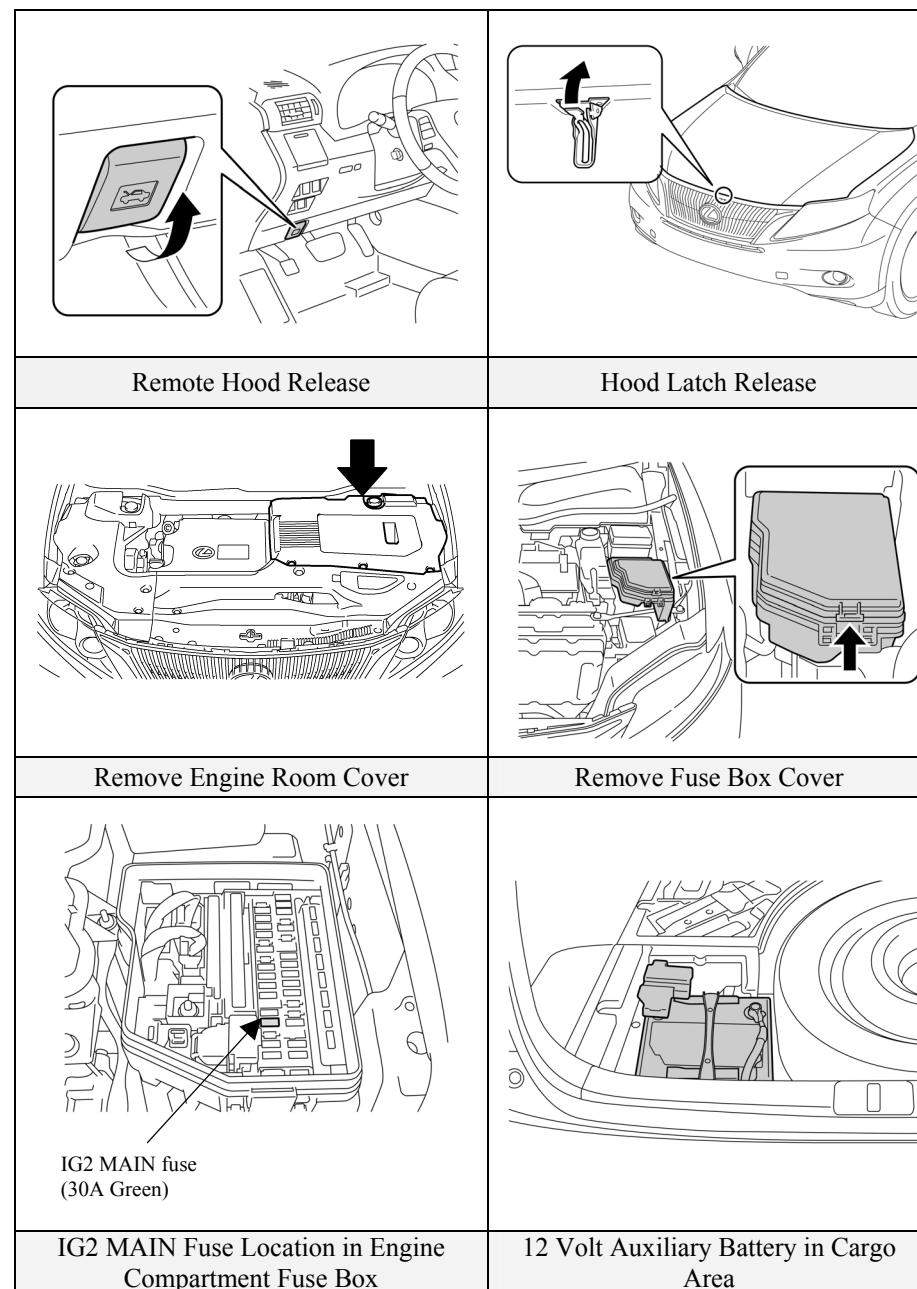

Emergency Response (Continued)

Extrication (Continued)

- Stabilize Vehicle

Crib at (4) points directly under the front and rear pillars.
Do not place cribbing under the high voltage power cables, exhaust system, or fuel system.

NOTE:

The RX 450h is equipped with a tire pressure warning system that by design prevents pulling the metal valve stem with integral transmitter from the wheel. Snapping the valve stem with pliers or removing the valve cap and Schrader valve will release the air in the tire.

The RX 450h may be equipped with an optional air suspension system. In the event of a collision, fire or malfunction, air leakage may occur, allowing the body to drop.

- Access Patients

Glass Removal

The RX 450h is equipped with laminated front side windows having similar properties as laminated windshield glass. If side glass removal is required, use the same techniques as the front windshield glass.

SRS Awareness

Responders need to be cautious when working in close proximity to undeployed airbags and seat belt pretensioners. Front dual stage airbags automatically ignite both stages within a fraction of a second.

Door Removal/Displacement

Doors can be removed by conventional rescue tools such as hand, electric, and hydraulic tools. In certain situations, it may be easier to pry back the vehicle body to expose and unbolt the hinges.

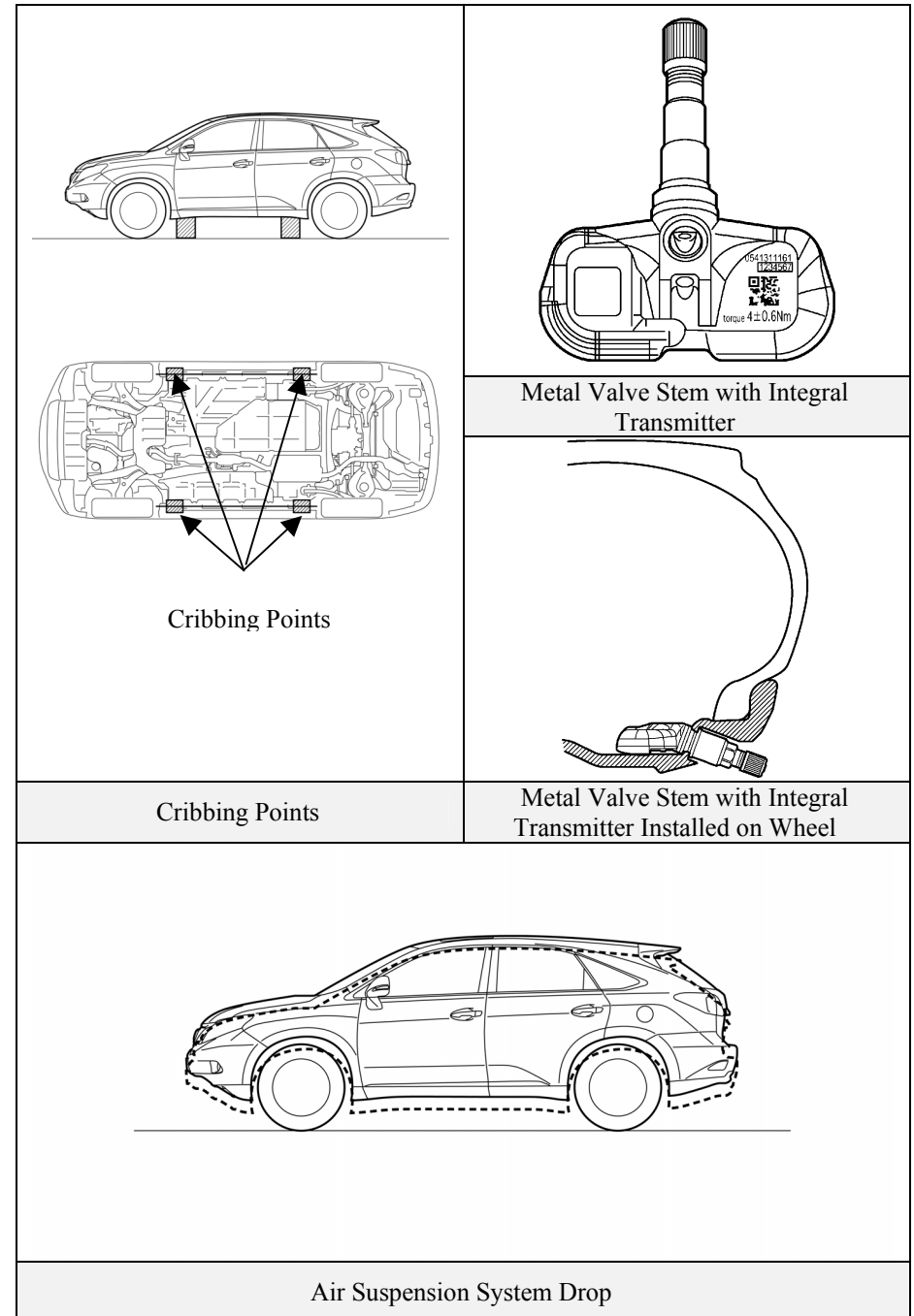

Emergency Response (Continued)

Extrication (Continued)

Roof Removal

The RX 450h is equipped with side curtain airbags. When undeployed, total roof removal is not recommended. Patient access through the roof can be performed by cutting the roof center section inboard of the roof rails as illustrated. This would avoid breaching the side curtain airbags, inflators, and wiring harness.

NOTE:

The side curtain airbags may be identified as illustrated on this page (additional component details on page 17).

Dash Displacement

The RX 450h is equipped with side curtain airbags. When undeployed, total roof removal is not recommended to avoid breaching the side curtain airbags, inflators, and wiring harness. As an alternative, dash displacement may be performed by using a Modified Dash Roll.

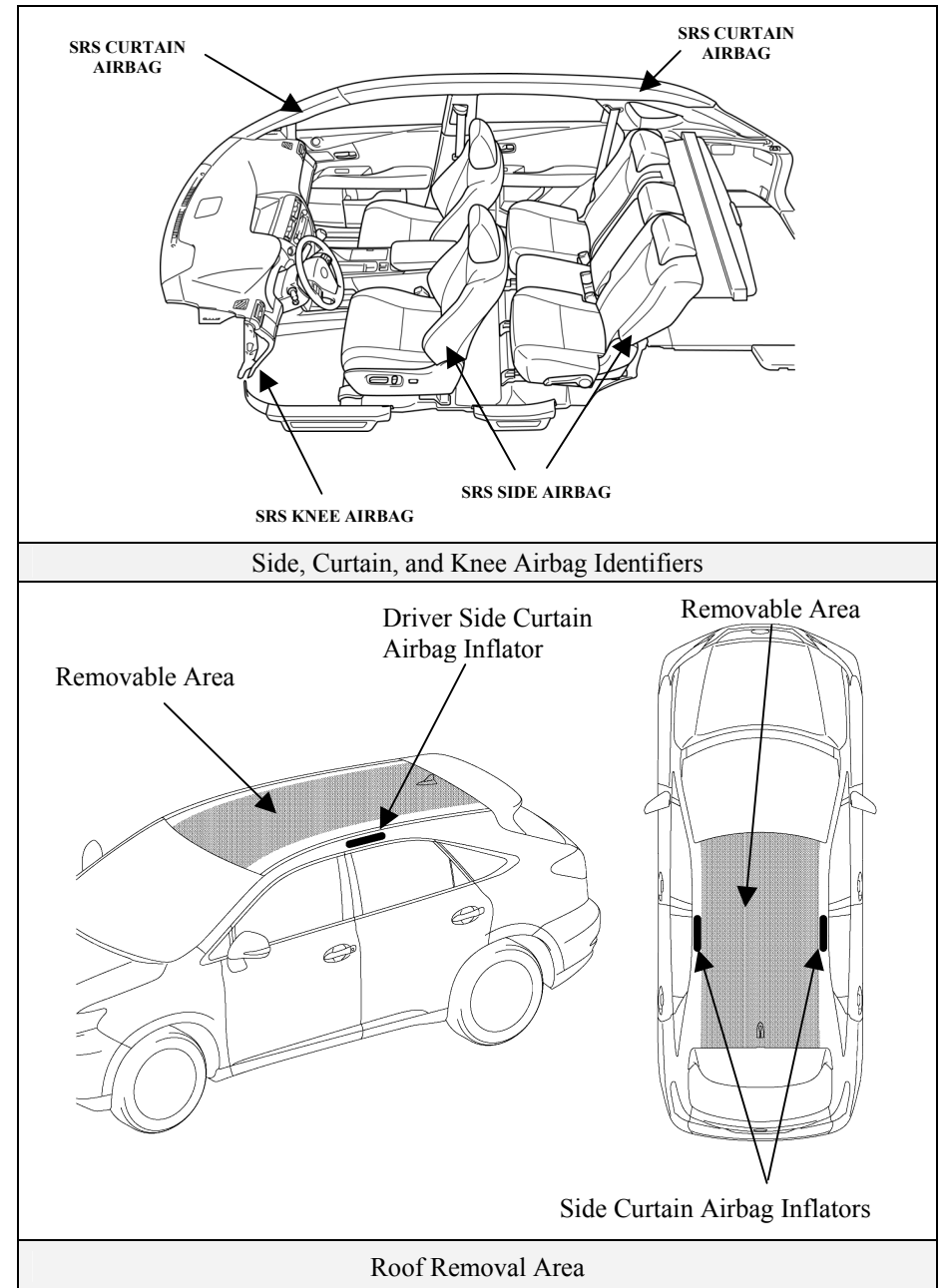

Emergency Response (Continued)

Extrication (Continued)

Rescue Lift Air Bags

Responders should not place cribbing or rescue lift air bags under the high voltage power cables, exhaust system, or fuel system.

Repositioning Steering Wheel and Front Seats

Telescopic steering wheel and seat controls are shown in the illustrations.

NOTE:

The RX 450h is equipped with an optional power driver seat leg support adjustment. The length of the cushion pad can be adjusted by raising or lowering the front portion of the driver seat cushion in the event of a dashboard entrapment. The control switch for the optional leg support adjustment is located to the far left on the power seat panel.

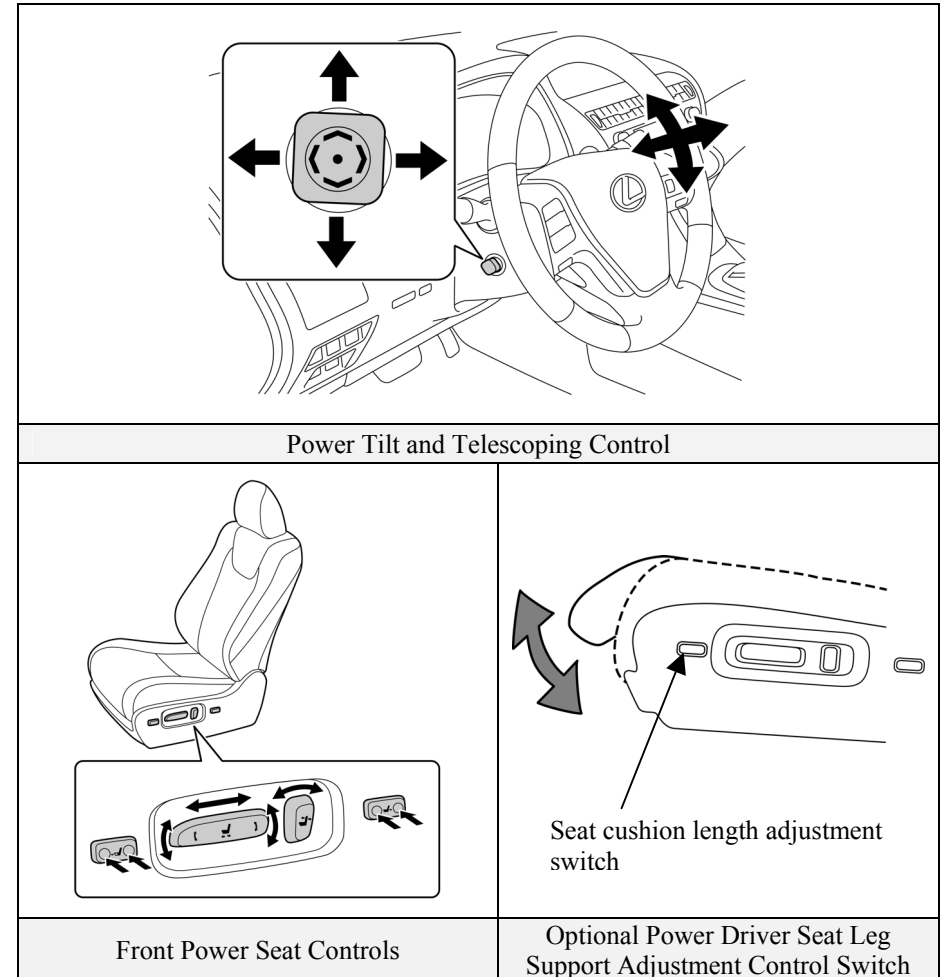

Emergency Response (Continued)

Extrication (Continued)

Active Headrest Removal

The RX 450h is equipped with active headrests, located in both front seatbacks. The active headrests are mechanical non-pyrotechnic head supports that are designed to help reduce neck injuries in the event of a rear collision.

No special methods are required to remove the headrests. Push the release button and lift to remove the headrest.

NOTE:

The RX 450h is equipped with an electrochromic auto dimming rear view mirror. The mirror contains a minimal amount of transparent gel sealed between two glass plates that will not normally leak.

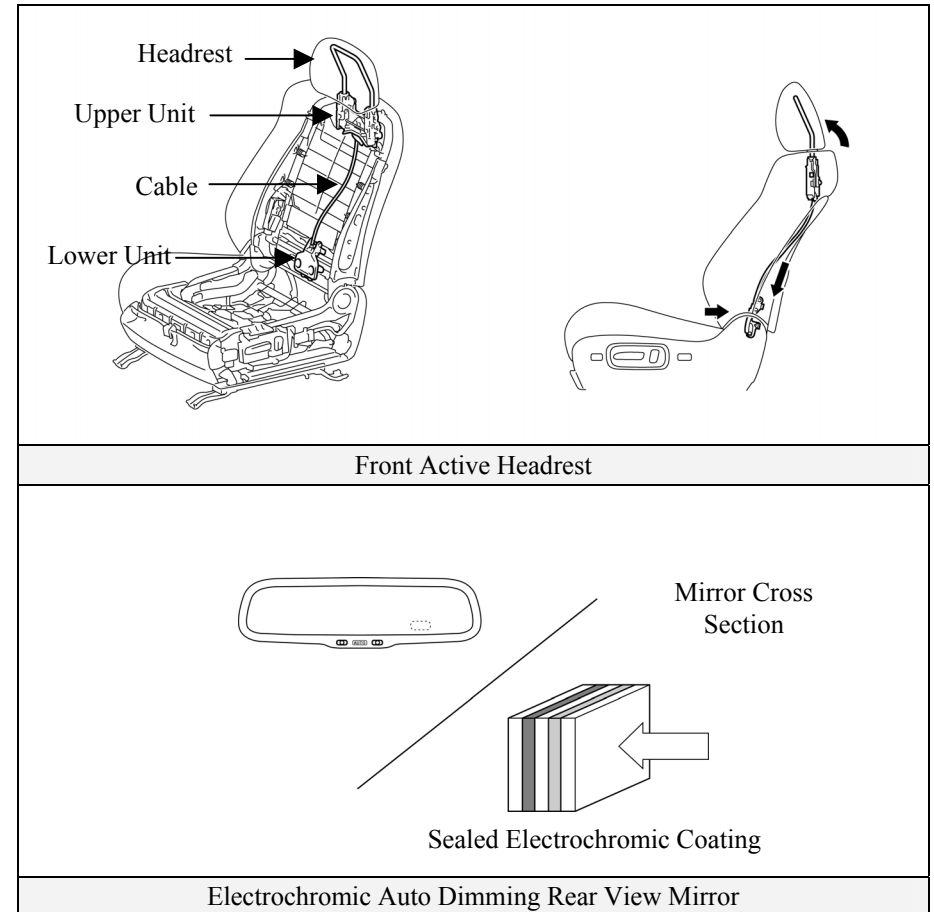

Emergency Response (Continued)

Fire

Approach and extinguish a fire using proper vehicle fire fighting practices as recommended by NFPA, IFSTA, or the National Fire Academy (USA).

- Extinguishing Agent
Water has been proven to be a suitable extinguishing agent.
- Initial Fire Attack
Perform a fast, aggressive fire attack.
Divert the runoff from entering watershed areas.
Attack teams may not be able to identify a RX 450h until the fire has been knocked down and overhaul operations have commenced.
- Fire in the HV Battery Pack
Should a fire occur in the NiMH HV battery pack, attack crews should utilize a water stream or fog pattern to extinguish any fire within the vehicle except for the HV battery pack.

WARNING:

- *The NiMH battery electrolyte is a caustic alkaline (pH 13.5) that is damaging to human tissues. To avoid injury by coming in contact with the electrolyte, wear proper personal protective equipment.*
- *The battery modules are contained within a metal case and accessibility is limited.*
- *To avoid serious injury or death from severe burns or electric shock, **never** breach or remove the high voltage battery pack cover under any circumstance including fire.*

When allowed to burn themselves out, the RX 450h NiMH battery modules burn rapidly and can quickly be reduced to ashes except for the metal.

Offensive Fire Attack

Normally, flooding a NiMH HV battery pack with copious amounts of water at a safe distance will effectively control the HV battery pack fire by cooling the adjacent NiMH battery modules to a point below their ignition temperature. The remaining modules on fire, if not extinguished by the water, will burn themselves out.

However, flooding the RX 450h HV battery pack is not recommended due to the battery case design and location preventing the responder from properly applying water through the available vent openings safely. Therefore, it is recommended that the incident commander allow the RX 450h HV battery pack to burn itself out.

Defensive Fire Attack

If the decision has been made to fight the fire using a defensive attack, the fire attack crew should pull back a safe distance and allow the NiMH battery modules to burn themselves out. During this defensive operation, fire crews may utilize a water stream or fog pattern to protect exposures or to control the path of smoke.

Emergency Response (Continued)

Overhaul

During overhaul, immobilize and disable the vehicle if not already done. Refer to illustrations on page 17 and 18. The HV battery cover should *never* be breached or removed under any circumstances including fire. Doing so may result in severe electrical burns, shock, or electrocution.

- Immobilize Vehicle
 - Chock wheels and set the parking brake.
 - Move the shift lever to the **Park** position.
- Disable Vehicle
 - Performing either of the following two procedures will shut the vehicle off and disable the HV battery pack, SRS, and gasoline fuel pump.

Procedure #1

1. Confirm the status of the **READY** indicator in the instrument cluster.
2. If the **READY** indicator is illuminated, the vehicle is on and operational. Shut off the vehicle by pushing the power button once.
3. The vehicle is already shut off if the instrument cluster lights and the **READY** indicator are not illuminated. Do **not** push the power button because the vehicle may start.
4. If the smart key is easily accessible, keep it at least 16 feet (5 meters) away from the vehicle.
5. If the smart key cannot be found, disconnect the 12 Volt auxiliary battery under the cover in the cargo area to prevent accidental restarting of the vehicle.

Procedure #2 (Alternate if power button is inaccessible)

1. Remove the engine cover.
2. Remove the fuse box cover.
3. Remove the **IG2 MAIN** fuse (30A green colored) in the engine compartment fuse box as illustrated on page 20. If the correct fuse cannot be recognized, pull all fuses in the fuse box.
4. Disconnect the 12 Volt auxiliary battery under the cover in the cargo area.

Recovering/Recycling of NiMH HV Battery Pack

Clean up of the HV battery pack can be accomplished by the vehicle recovery crew without further concern of runoff or spillage. For information regarding recycling of the HV battery pack, contact the nearest Lexus dealer, or:

United States: (800) 255-3987, Canada: (800) 265-3987

Emergency Response (Continued)

Spills

The RX 450h contains the same common automotive fluids used in other non-hybrid Lexus vehicles, with the exception of the NiMH electrolyte used in the HV battery pack. The NiMH battery electrolyte is a caustic alkaline (pH 13.5) that is damaging to human tissues. The electrolyte, however, is absorbed in the cell plates and will not normally spill or leak out even if a battery module is cracked. A catastrophic crash that would breach both the metal battery pack case and a battery module would be a rare occurrence.

Similar to the use of baking soda to neutralize a lead-acid battery electrolyte spill, a dilute boric acid solution or vinegar can be used to neutralize a NiMH battery electrolyte spill.

NOTE:

Electrolyte leakage from the HV battery pack is unlikely due to its construction and the amount of available electrolyte contained within the NiMH modules. Any spillage would not warrant a declaration as a hazardous material incident. Responders should follow the recommendations as outlined in this emergency response guide.

In an emergency, manufacturer's Material Safety Data Sheets (MSDS) are available by contacting:

United States: CHEMTREC at (800) 424-9300

Canada: CANUTEC at *666 or (613) 996-6666 (collect)

- Handle NiMH electrolyte spills using the following Personal Protective Equipment (PPE):
 - Splash shield or safety goggles. Fold down helmet shields are not acceptable for acid or electrolyte spills.
 - Rubber, latex or nitrile gloves.
 - Apron suitable for alkaline.
 - Rubber boots.
- Neutralize NiMH Electrolyte
 - Use a boric acid solution or vinegar.
 - Boric acid solution - 800 grams boric acid to 20 liters water or 5.5 ounces boric acid to 1 gallon of water.

First Aid

Emergency responders may not be familiar with a NiMH electrolyte exposure when rendering aid to a patient. Exposure to the electrolyte is unlikely except in a catastrophic crash or through improper handling. Utilize the following guidelines in the event of exposure.

WARNING:

The NiMH battery electrolyte is a caustic alkaline (pH 13.5) that is damaging to human tissues. To avoid injury by coming in contact with the electrolyte, wear proper personal protective equipment.

- Wear Personal Protective Equipment (PPE)
 - Splash shield or safety goggles. Fold down helmet shields are not acceptable for acid or electrolyte spills.
 - Rubber, latex or nitrile gloves.
 - Apron suitable for alkaline.
 - Rubber boots.
- Absorption
 - Perform gross decontamination by removing affected clothing and properly disposing of the garments.
 - Rinse the affected areas with water for 20 minutes.
 - Transport patients to the nearest emergency medical care facility.
- Inhalation in Non-Fire Situations
 - No toxic gases are emitted under normal conditions.
- Inhalation in Fire Situations
 - Toxic gases are given off as by-products of combustion. All responders in the Hot Zone should wear the proper PPE for fire fighting including SCBA.
 - Move a patient from the hazardous environment to a safe area and administer oxygen.
 - Transport patients to the nearest emergency medical care facility.
- Ingestion
 - Do not induce vomiting.
 - Allow the patient to drink large quantities of water to dilute the electrolyte (never give water to an unconscious person).

Emergency Response (Continued)

First Aid (Continued)

If vomiting occurs spontaneously, keep the patient's head lowered and forward to reduce the risk of asphyxiation.

Transport patients to the nearest emergency medical care facility.

Submersion

A submerged hybrid vehicle does not have high voltage potential on the metal vehicle body, and is safe to touch.

Access Patients

Responders can access the patient and perform normal extrication procedures. High voltage orange color coded power cables and high voltage components should never be touched, cut, or breached.

Vehicle Recovery

If a hybrid vehicle is fully or partially submerged in water, emergency responders may not be able to determine if the vehicle has been automatically disabled. The RX 450h may be handled by following these recommendations:

1. Remove the vehicle from the water.
2. Drain the water from the vehicle if possible.
3. Follow the immobilizing and disabling procedures on page 18.

Roadside Assistance

Roadside assistance for the RX 450h may be handled like conventional Lexus vehicles except as noted in the following pages.

Lexus Roadside Assistance is available during the basic warranty period by contacting:

United States: (800) 255-3987, Canada: (800) 265-3987

Shift Lever

Similar to many Lexus vehicles, the RX 450h uses a gated shift lever as shown in the illustration. However, the RX 450h shift lever includes an S position, allowing the selection of 6 levels of engine braking.

Towing

RX450h models with all wheel drive must be towed with all four wheels off the ground. Models with front wheel drive must be towed with the front (drive) wheels off the ground. Failure to do so may cause serious damage to vehicle components. If it is not possible to determine whether the vehicle is AWD or FWD, tow the vehicle with all wheels off the ground.

- The vehicle may be shifted out of **Park** into **Neutral** by turning the ignition-on, depressing the brake, then moving the gated shift lever to **N**.
- If the shift lever cannot be moved out of **Park**, a shift lock release button is provided under the cover near the shift lever as shown in the illustration.
- If a tow truck is not available, in an emergency the vehicle may be temporarily towed using a cable or chain secured to the emergency towing eyelet or rear hooks. This should only be attempted on hard, paved roads for short distances at low speeds. The eyelet is located with the tools in the cargo area of the vehicle, refer to the illustration on page 31.

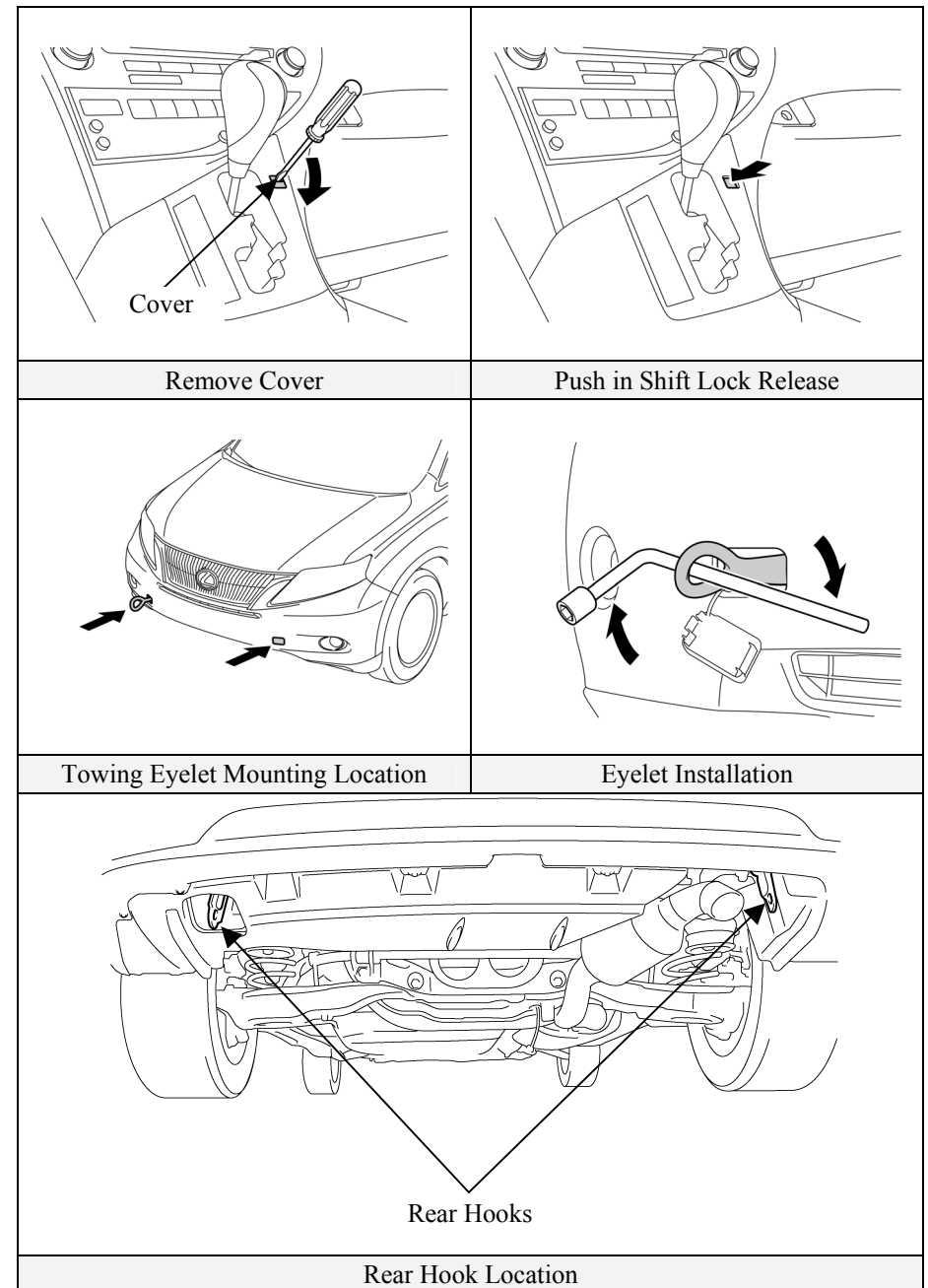

Roadside Assistance (Continued)

Electric Back Door Opener

The RX 450h is equipped with an electric back door opener. In the event of 12 Volt power loss, the back door cannot be opened from the outside of the vehicle.

The electric back door can be opened manually using the release as shown in the illustration.

Electric Fuel Door Opener

The RX 450h is equipped with an electric fuel door opener. In the event of 12 Volt power loss, the fuel door can only be opened using the manual release located inside the cargo area.

⚠ WARNING:

The RX 450h has a fuel vapor containment system that results in the tank pressure being higher than that of a conventional vehicle. If the fuel filler cap is removed after using the manual fuel door release, the vehicle will not automatically reduce the fuel tank pressure. Opening the fuel cap in this state will allow pressurized fuel vapors to escape, and fuel may also be discharged from the filler inlet. For these reasons, be extremely careful and open the fuel cap slowly.

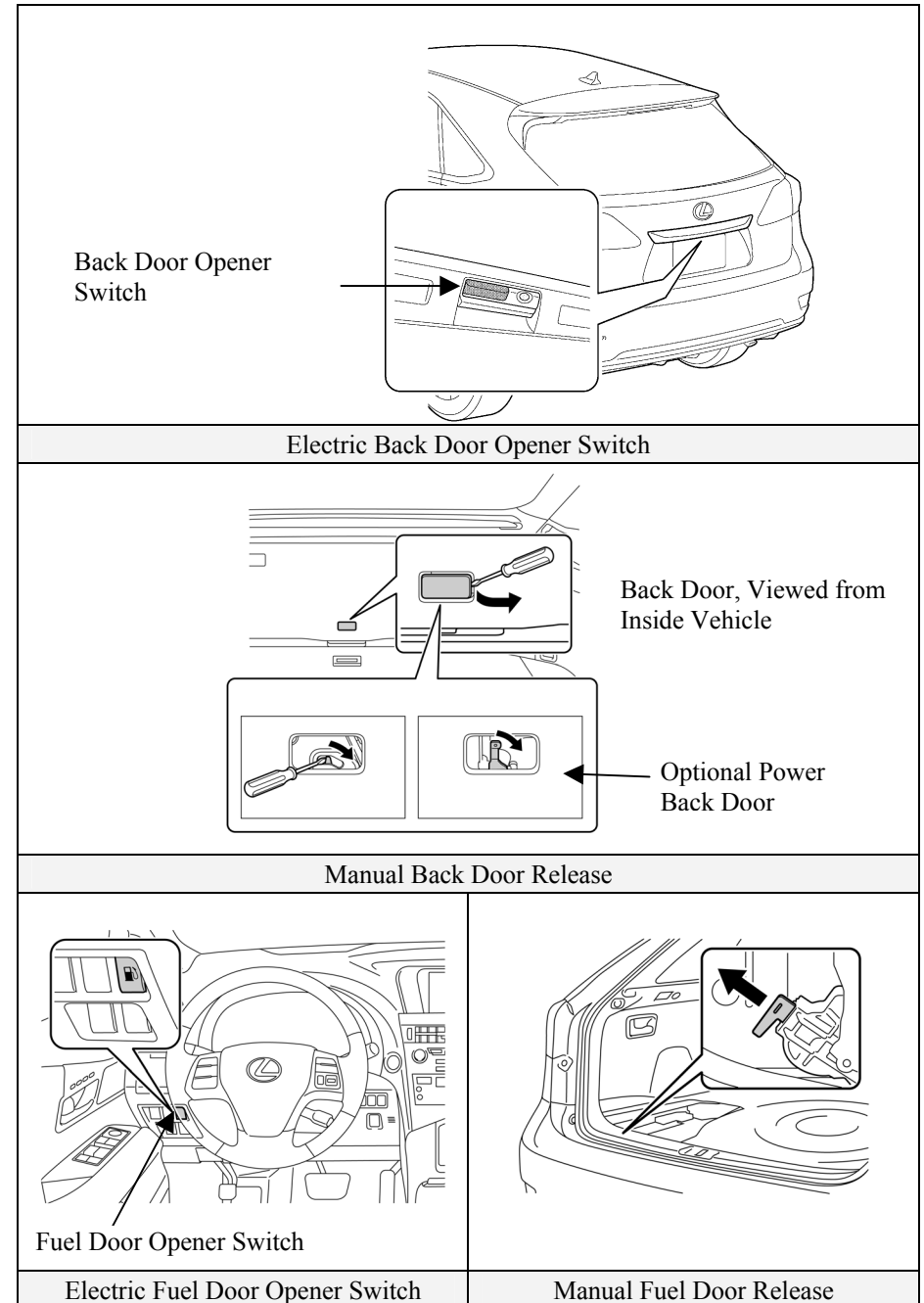

Roadside Assistance (Continued)

Spare Tire

The jack, tools, towing eyelet and spare tire are provided as shown.

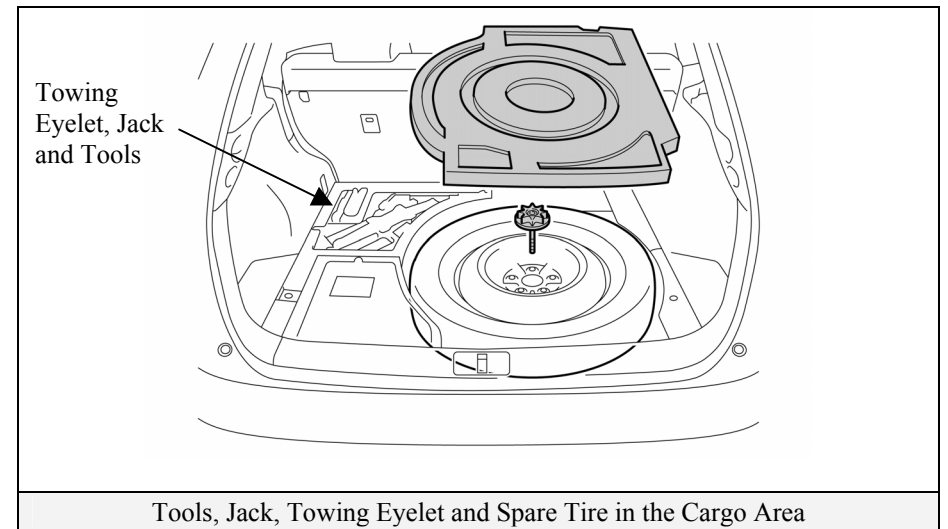

Roadside Assistance (Continued)

Jump Starting

The 12 Volt auxiliary battery may be jump started if the vehicle does not start and the instrument cluster gauges are dim or off after depressing the brake pedal and pushing the power button.

The 12 Volt auxiliary battery is located in the cargo area. If the 12 Volt auxiliary battery is discharged, the rear back door cannot be opened. Instead, the vehicle can be jump started by accessing the remote positive 12 Volt auxiliary battery terminal in the engine compartment fuse box.

- Open the hood, and remove the engine room cover.
- Remove the fuse box cover, and open the positive terminal cover.
- Connect the positive jumper cable to the positive terminal.
- Connect the negative jumper cable to a solid ground.
- Place the smart key in proximity to the interior of the vehicle, depress the brake pedal, and push the power button.

NOTE:

If the vehicle does not recognize the smart key after connecting the booster battery to the vehicle, open and close the driver door when the vehicle is shut off.

If the smart key internal battery is dead, touch the Lexus emblem side of the smart key to the power button during the start sequence. See the instructions and illustrations on page 10 for more details.

- The high voltage HV battery pack cannot be jump started.

Immobilizer & Anti-Theft Alarm

The RX 450h is equipped with a standard immobilizer system and an anti-theft alarm.

- The vehicle can be started only with a registered smart key.

- To disarm the anti-theft alarm, unlock the door by using the smart key button, hidden metal cut key, or door handle touch sensor. Turning the ignition-on or starting the vehicle will also disarm the anti-theft alarm.

