

 **TOYOTA**
HIGHLANDER



Hybrid
2008 Model 2nd Generation
Revised (Includes 2011 Model Updates)

Emergency Response Guide



Foreword

The 2nd generation Toyota Highlander gasoline-electric hybrid Emergency Response Guide has been revised to include the changes of the 2011 model year vehicle. These changes include minor updates to the gasoline engine, vehicle exterior and interior. The important change affecting the emergency responder is the relocation of the 12 Volt auxiliary battery from the engine compartment to the rear cargo area. The 2nd generation Highlander hybrid introduced in May 2007 continues to share the basic vehicle systems and features of the conventional, non-hybrid, Highlander.

High voltage electricity powers the electric motors, generator, A/C compressor, and inverter/converter. All other automotive electrical devices such as the headlights, radio, and gauges are powered from a separate 12 Volt auxiliary battery. Numerous safeguards have been designed into the Highlander hybrid to help ensure the high voltage, approximately 288 Volt, Nickel Metal Hydride (NiMH) Hybrid Vehicle (HV) battery pack is kept safe and secure in an accident.

The Highlander hybrid utilizes the following electrical systems:

- Maximum 650 Volts AC
- Nominal 288 Volts DC
- Nominal 12 Volts DC

2nd Generation Highlander Hybrid Features:

- Complete model change with a new exterior and interior design.
- Smart key and mechanical ignition key systems available.
- A boost converter in the inverter/converter that boosts to 650 Volts the available voltage to the electric motors.
- A high voltage Hybrid Vehicle (HV) battery pack rated at 288 Volts.
- High voltage motor driven Air Conditioning (A/C) compressor rated at 288 Volts.
- A body electrical system rated at 12 Volts, negative chassis ground.
- Standard four-wheel-drive intelligent (4WD-i) with front and rear 650 Volt electric motors.
- Supplemental Restraint System (SRS) – dual stage frontal airbags, front seat mounted side airbags, side curtain airbags, front seatbelt pretensioners, and a driver side knee airbag.

High voltage electrical safety remains an important factor in the emergency handling of the Highlander Hybrid Synergy Drive. It is important to recognize and understand the disabling procedures and warnings throughout the guide.

Additional topics in the guide include:

- Toyota Highlander hybrid identification.
- Major Hybrid Synergy Drive component locations and descriptions.
- Extrication, fire, recovery, and additional emergency response information.
- Roadside assistance information.

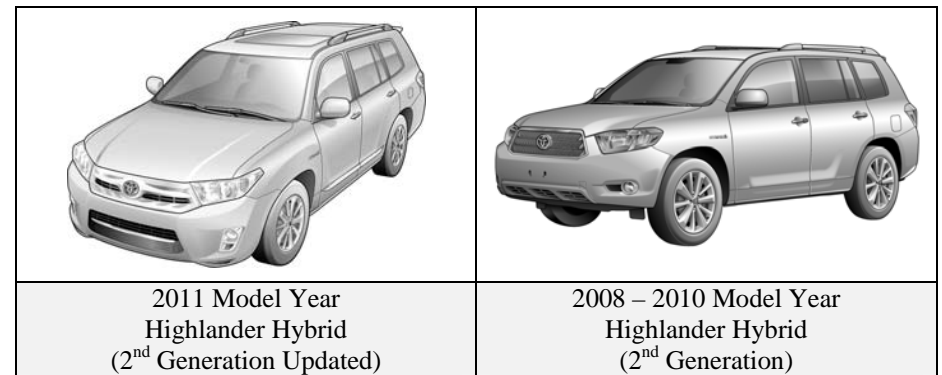

This guide is intended to assist emergency responders in the safe handling of a Toyota Highlander hybrid vehicle during an incident.

NOTE:

Emergency Response Guides for Toyota hybrid and alternative fuel vehicles may be viewed at <http://techinfo.toyota.com>.

Table of Contents	Page
About the Highlander Hybrid	1
Highlander Hybrid Identification	2
Hybrid Synergy Drive Component Locations & Descriptions	6
Smart Key System (Optional Equipment)	9
Hybrid Synergy Drive Operation	13
Hybrid Vehicle (HV) Battery Pack	14
Low Voltage Battery	15
High Voltage Safety	16
SRS Airbags & Seat Belt Pretensioners	17
Emergency Response	19
Extrication	19
Fire	27
Overhaul	28
Recovering/Recycling of NiMH HV Battery Pack	28
Spills	29
First Aid	29
Submersion	30
Roadside Assistance	31

About the Highlander Hybrid

The Highlander hybrid continues into its 2nd generation as a gasoline-electric hybrid vehicle. Hybrid Synergy Drive means that the vehicle contains a gasoline engine and electric motors for power. The two hybrid power sources are stored on board the vehicle:

1. Gasoline stored in the fuel tank for the gasoline engine.
2. Electricity stored in a high voltage Hybrid Vehicle (HV) battery pack for the electric motors.

The result of combining these two power sources is improved fuel economy and reduced emissions. The gasoline engine also powers an electric generator to recharge the battery pack; unlike a pure all electric vehicle, the Highlander hybrid never needs to be recharged from an external electric power source.

Depending on the driving conditions one or both sources are used to power the vehicle. The following illustration demonstrates how the Highlander hybrid operates in various driving modes.

- ❶ During light acceleration at low speeds, the vehicle is powered by the electric motors. The gasoline engine is shut off.
- ❷ During normal driving, the vehicle is powered mainly by the gasoline engine. The gasoline engine also powers the generator to recharge the battery pack.

- ❸ During full acceleration, such as climbing a hill, both the gasoline engine and the electric motor power the vehicle.
- ❹ During deceleration, such as when braking, the vehicle regenerates the kinetic energy from the wheels to produce electricity that recharges the battery pack.
- ❺ While the vehicle is stopped, the gasoline engine and electric motors are off, however the vehicle remains on and operational.

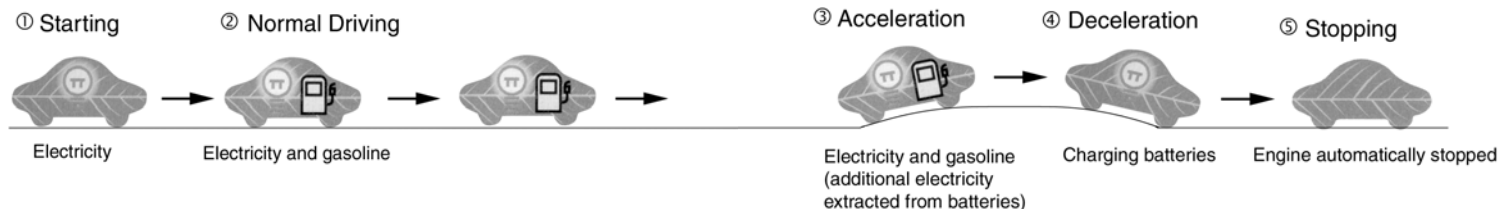

Highlander Hybrid Identification

In appearance, the 2011 model year Highlander hybrid is nearly identical to the conventional, non-hybrid Toyota Highlander. The Highlander hybrid is a 5-door SUV. Exterior, interior, and engine compartment illustrations are provided to assist in identification.

The alphanumeric 17 character Vehicle Identification Number (VIN) is provided in the front windshield cowl and driver door pillar.

Example VIN: JTEEW41AF82020211 (2008 - 2010 Models)

JTEBC3EHF82020211 (2011 Model)

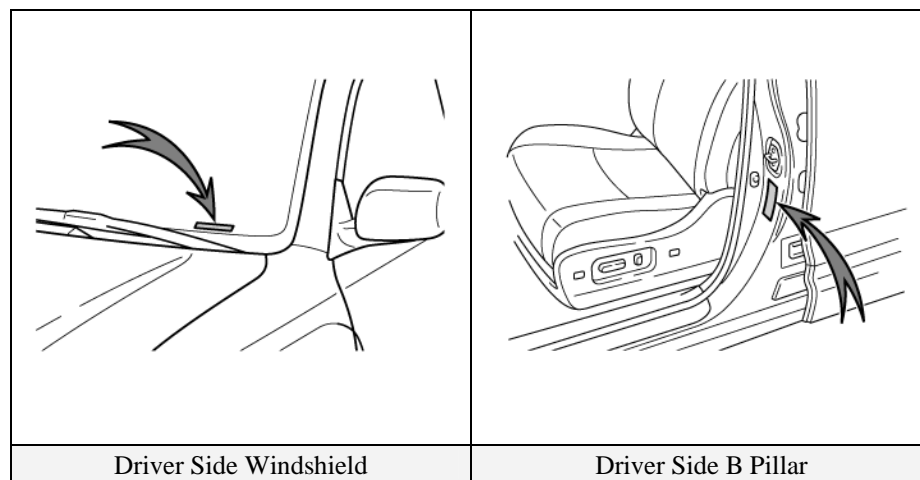

JTEBD3EHF82020211 (2011 Model)

A Highlander hybrid is identified by the first 6 alphanumeric characters **JTEEW4, JTEBC3 or JTEBD3**.



Highlander Hybrid Identification (Continued)

Exterior

- ①  logo on the back door.
- ② Highlander logo on the back door panel garnish.
- ③  logo on each front fender.
- ④ Gasoline fuel filler door located on the driver side rear quarter panel.
- ⑤ A radiator grill that is unique to the hybrid model.

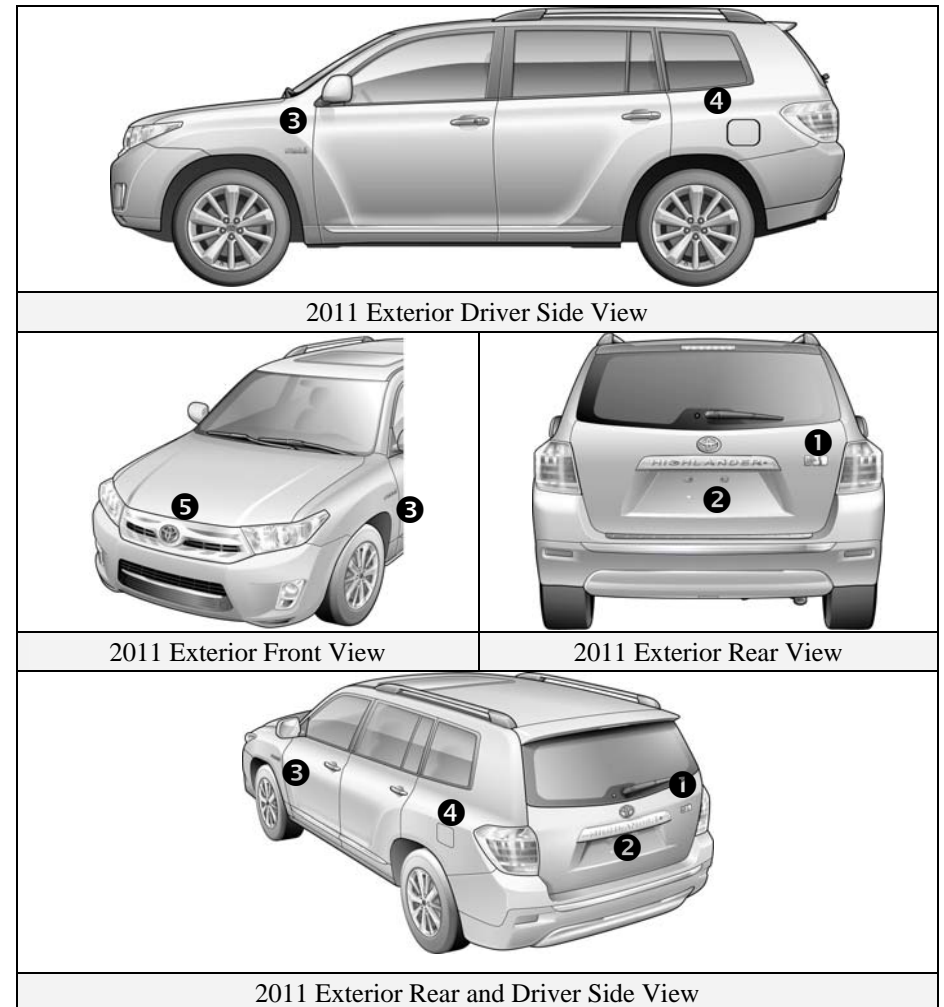
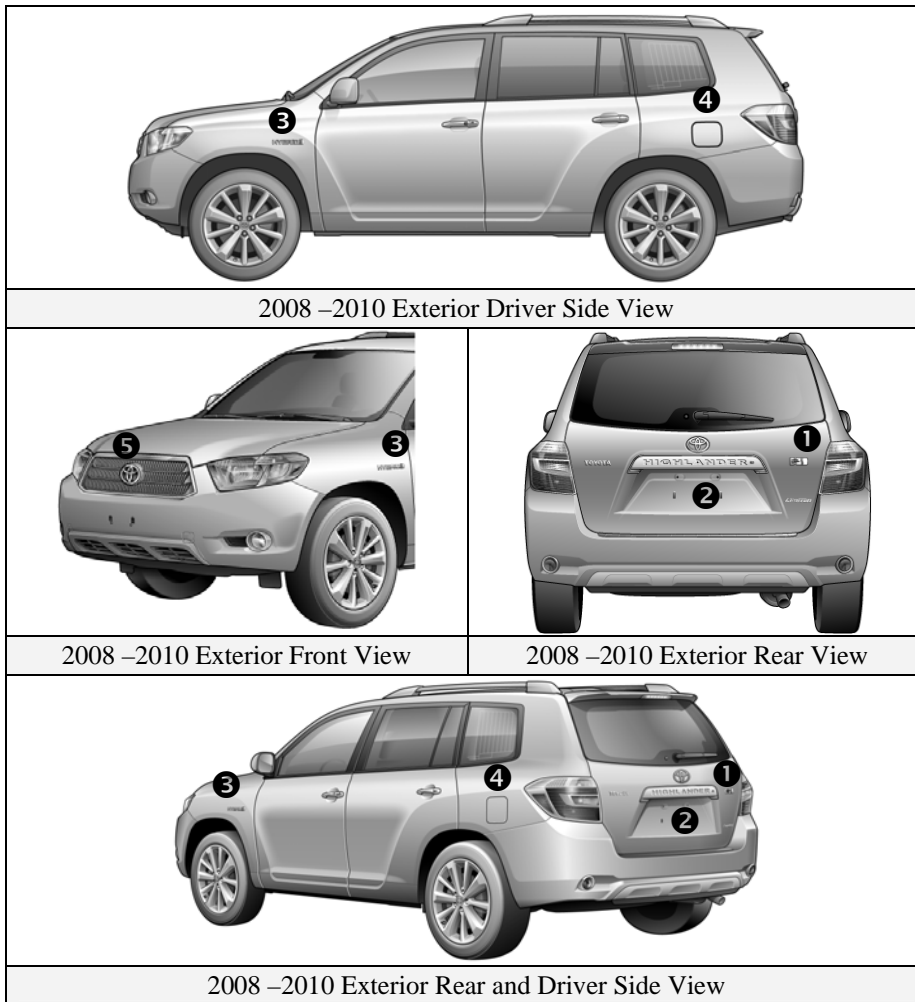

Highlander Hybrid Identification (Continued)

Interior

- ⑥ Highlander Hybrid front door sill/scuff plate. (Standard on 2008 - 2010 Models and optional on 2011 Model)
- ⑦ The instrument cluster (speedometer, fuel gauge, warning lights) located in the dash behind the steering wheel, is different than the one on the conventional, non-hybrid Highlander.
- ⑧ In place of a tachometer, a power meter showing kW output is used.

NOTE:

If the vehicle is shut off, the instrument cluster gauges will be “blacked out”, not illuminated.

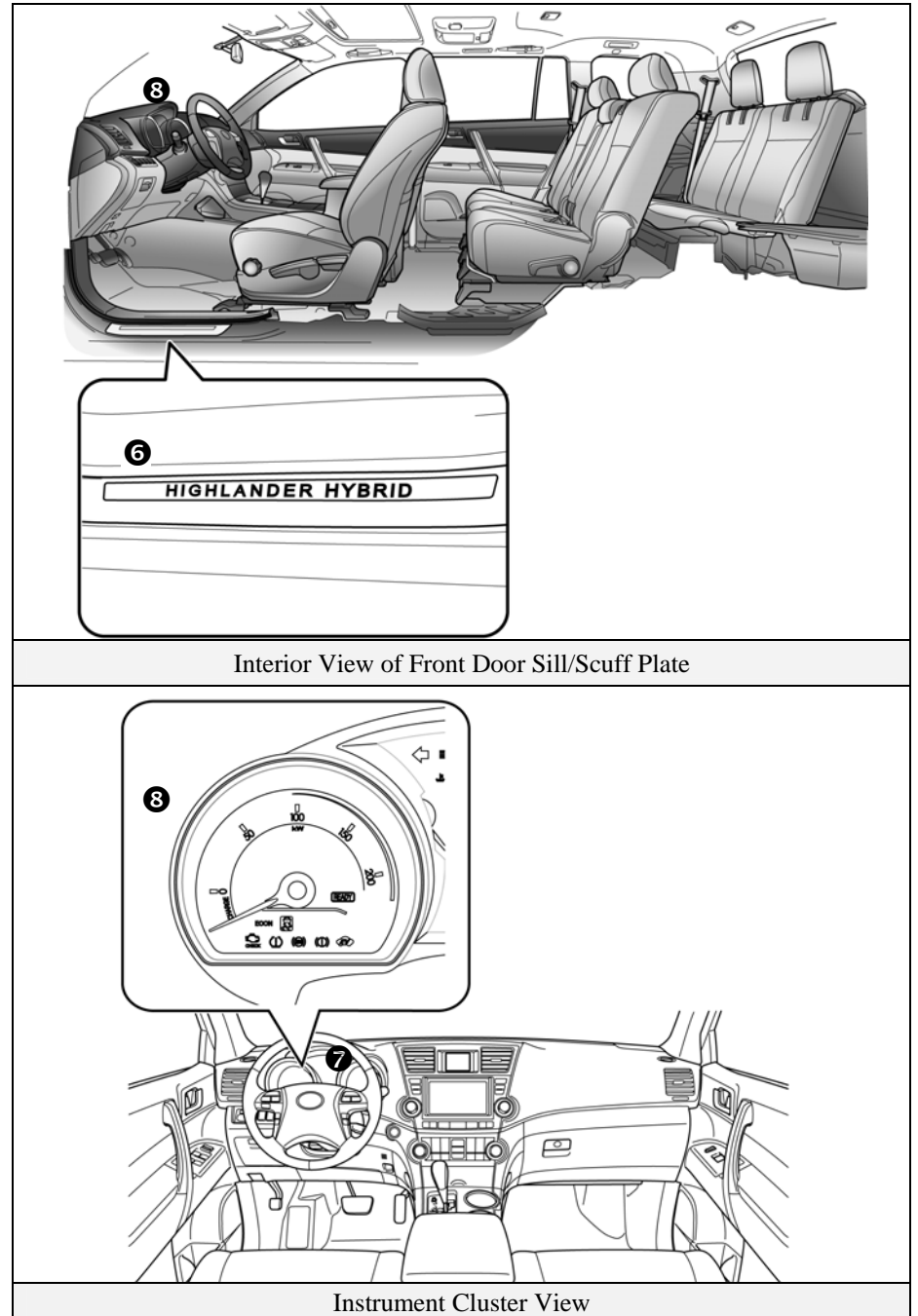

Highlander Hybrid Identification (Continued)

Engine Compartment

- ⑨ 3.3-liter aluminum alloy gasoline engine. (2008 - 2010 Models)
3.5-liter aluminum alloy gasoline engine. (2011 Model)
- ⑩ High voltage inverter/converter assembly with logo on the cover. (2008 - 2010 Models)
3.5-liter aluminum alloy gasoline engine with logo on the cover. (2011 Model)

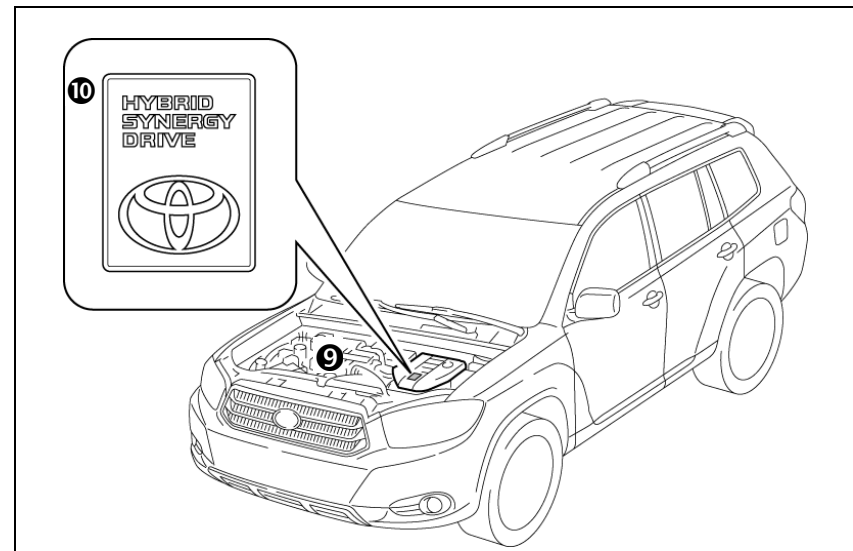

Engine Compartment View (2008 – 2010 Models)

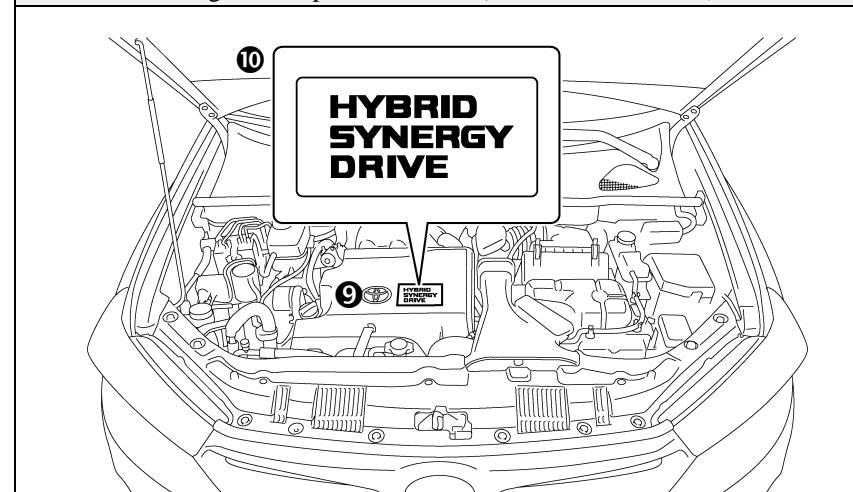

Engine Compartment View (2011 Model)

Hybrid Synergy Drive Component Locations & Descriptions

Component	Location	Description
12 Volt Auxiliary Battery 1	Engine Compartment (2008 - 2010 Models) Cargo Area (2011 Model)	A lead-acid battery that supplies power to the low voltage devices.
Hybrid Vehicle (HV) Battery Pack 2	Cabin Area, Mounted to Cross Member under Second Row Seat	288 Volt Nickel Metal Hydride (NiMH) battery pack consisting of 30 low voltage (9.6 Volt) modules connected in series.
Power Cables 3	Undercarriage and Engine Compartment	Orange colored power cables carry high voltage Direct Current (DC) between the HV battery pack, inverter/converter, and A/C compressor. These cables also carry 3-phase Alternating Current (AC) between the inverter/converter, electric motors, and generator.
Inverter/Converter 4	Engine Compartment	Boosts and inverts the high voltage electricity from the HV battery pack to 3-phase AC electricity that drives the electric motors. The inverter/converter also converts AC electricity from the electric generator and electric motors (regenerative braking) to DC that recharges the HV battery pack.
Gasoline Engine 5	Engine Compartment	Provides two functions: 1) Powers vehicle. 2) Powers generator to recharge the HV battery pack. The engine is started and stopped under control of the vehicle computer.
Front Electric Motor 6	Engine Compartment	3-phase high voltage AC permanent magnet electric motor contained in the front transaxle. It is used to power the front wheels.
Electric Generator 7	Engine Compartment	3-phase high voltage AC generator that is contained in the transaxle and recharges the HV battery pack.

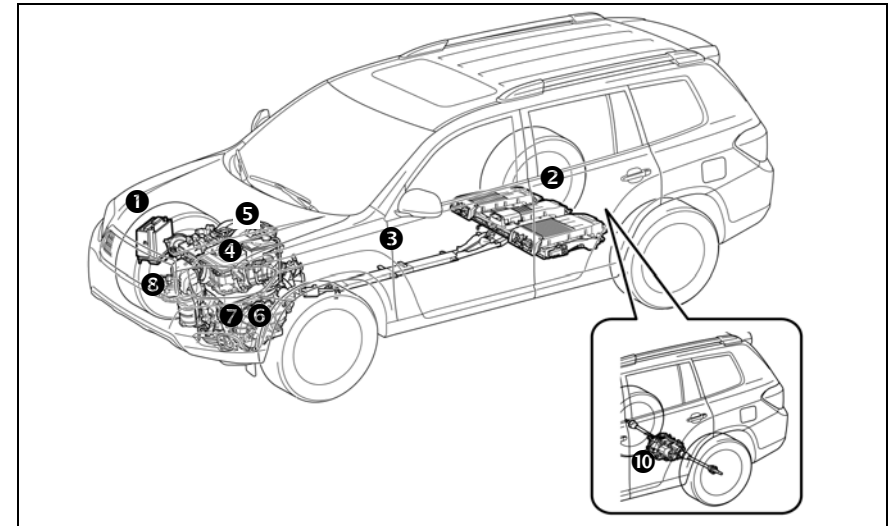

Hybrid Synergy Drive Components (2008 - 2010 Models)

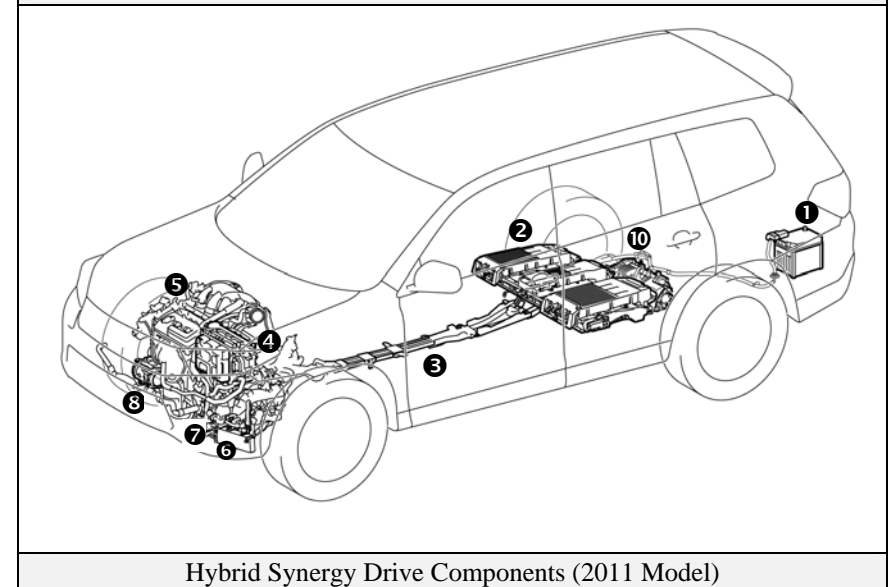

Hybrid Synergy Drive Components (2011 Model)

Hybrid Synergy Drive Component Locations & Descriptions (Continued)

Component	Location	Description
A/C Compressor (with Inverter) ⑧	Engine Compartment	3-phase high voltage AC electrically driven motor compressor.
Fuel Tank and Fuel Line ⑨	Undercarriage and Center	The fuel tank provides gasoline via a fuel line to the engine. The fuel line is routed under the center of vehicle.
Rear Electric Motor ⑩	Rear Sub-Frame	3-phase high voltage AC permanent magnet electric motor contained in the rear transaxle. It is used to power the rear wheels.

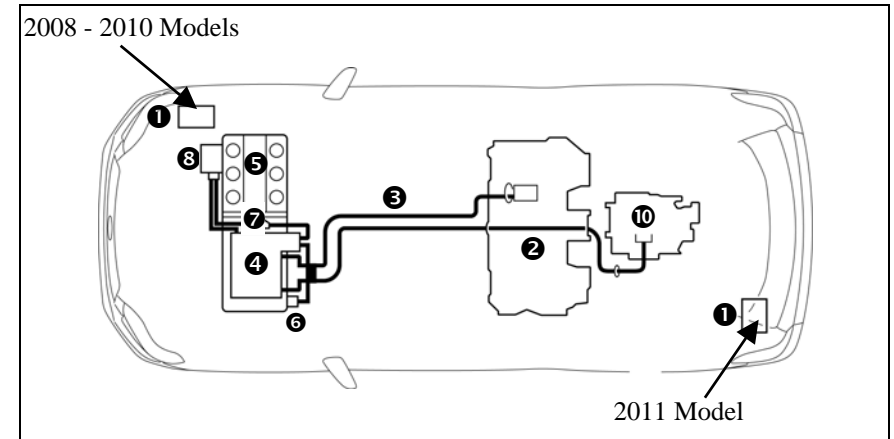

Components (Top View) and High Voltage Power Cables

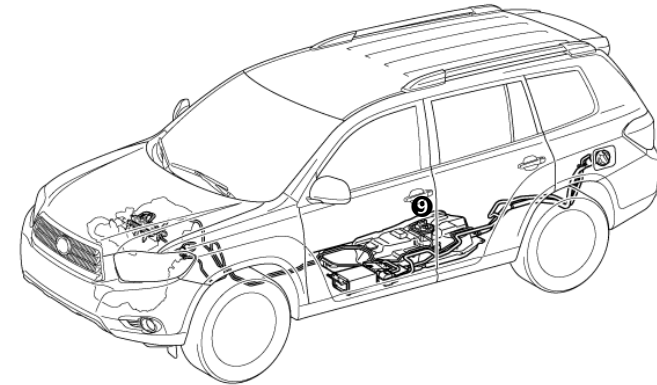

Fuel Tank and Fuel Line (2008 - 2010 Models)

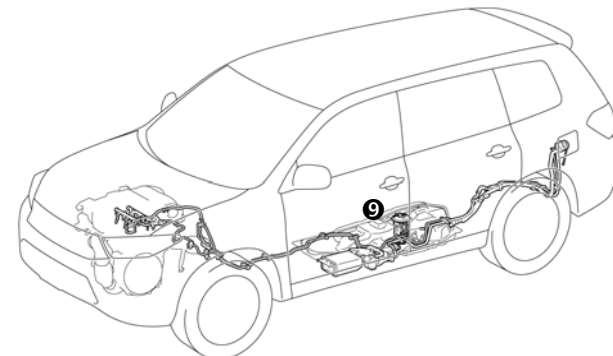

Fuel Tank and Fuel Line (2011 Model)

Hybrid Synergy Drive Component Locations & Descriptions (Continued)

Key Specifications:

- Gasoline Engine: 208 hp (156 kW), 3.3-liter Aluminum Alloy Engine (2008 - 2010 Models)
231 hp (172 kW), 3.5-liter Aluminum Alloy Engine (2011 Model)
- Electric Motors
Front: 165 hp (123 kW), Permanent Magnet Motor
Rear: 67 hp (50 kW), Permanent Magnet Motor
- Transmission: Automatic Only (electrically controlled continuously variable transaxle)
- HV Battery: 288 Volt Sealed NiMH-Battery
- Curb Weight: 4,641 lbs/2,105 kg (2008 - 2010 Models)
4,762 lbs/2,160 kg (2011 Model)
- Fuel Tank: 17.2 gals/65.0 liters
- Fuel Economy
Ratings: 27/25 (City/Hwy) miles/gal (2008 - 2010 Models)
28/28 (City/Hwy) miles/gal (2011 Model)
8.6/9.4 (City/Hwy) liters/100 km (2008 - 2010 Models)
6.6/7.3 (City/Hwy) liters/100 km (2011 Model)
- Frame Material: Steel Unibody
- Body Material: Steel Panels
- Seating Capacity: 5 passenger/7 passenger with optional 3rd row seating (2008 - 2010 Models)
7 passenger with standard 3rd row seating (2011 Model)

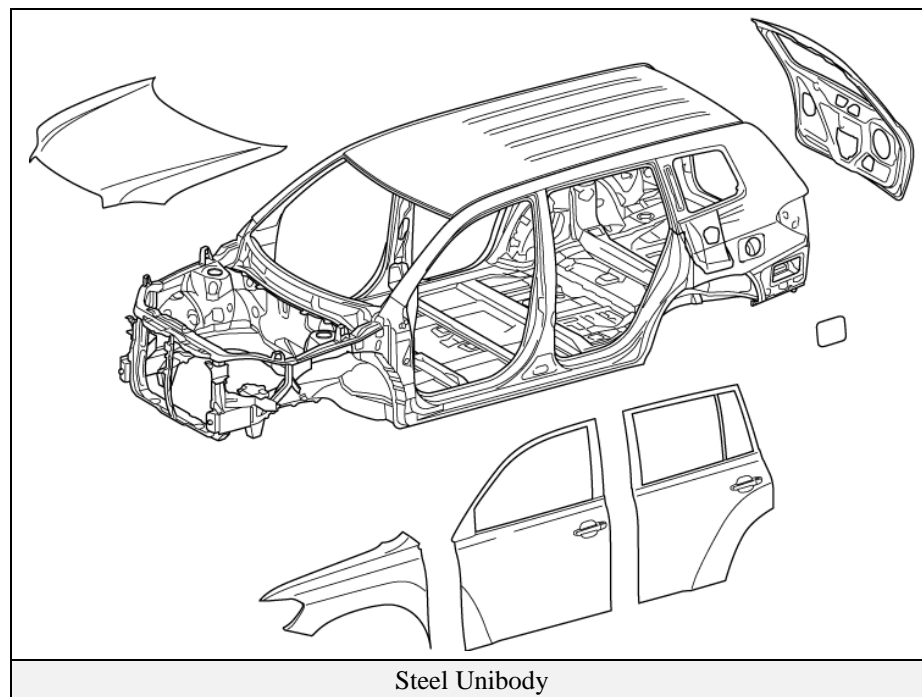

Smart Key System (Optional Equipment)

The Highlander hybrid smart key system, which is standard on 2008 - 2010 models and optional on the 2011 model, consists of a smart key transceiver that communicates bi-directionally, enabling the vehicle to recognize the smart key in proximity to the vehicle. Once recognized, the smart key will allow the user to lock and unlock the doors without pushing smart key buttons, and start the vehicle without inserting it into an ignition switch.

Smart key features:

- Passive (remote) function to lock/unlock the doors, unlock the optional glass hatch/power back door, and start the vehicle.
- Wireless transmitter buttons to lock/unlock all 5 doors.
- A wireless transmitter button to operate the optional power back door opener.
- Hidden metal cut key to lock/unlock the doors.

Door (Lock/Unlock)

There are several methods available to lock/unlock the doors.

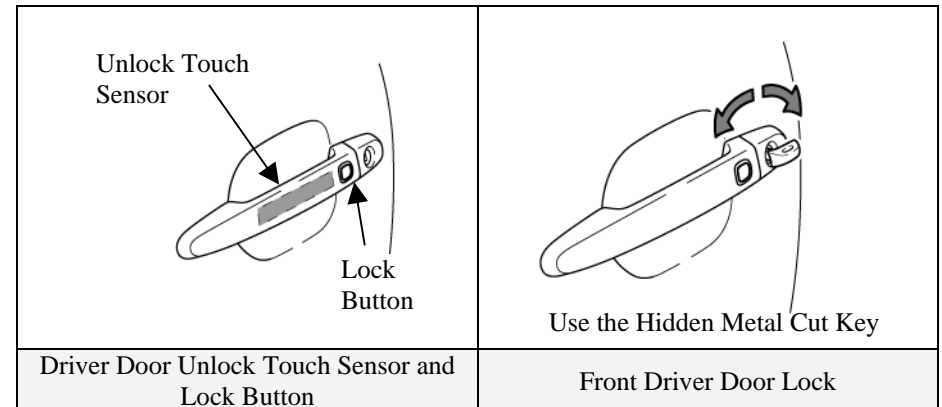
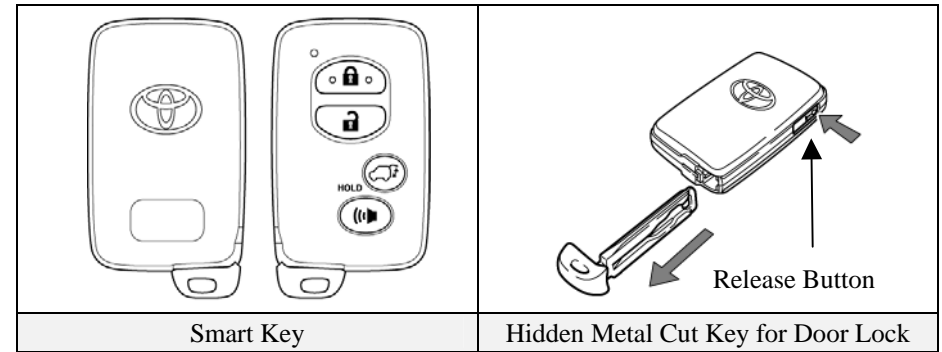

- Pushing the smart key lock/unlock buttons will lock/unlock all doors including the back door.
- Touching the sensor on the backside of the driver door exterior handle, with the smart key in proximity to the vehicle, unlocks the driver door. Touching the sensor on the backside of the passenger door exterior handle, with the smart key in proximity to the vehicle, unlocks all doors. Pushing the lock button on either front door, or the back door will lock all doors.
- Inserting the hidden metal cut key in the driver door lock and turning clockwise once unlocks the driver door, twice unlocks all doors. To lock all doors turn the key counter clockwise once. Only the driver door contains an exterior door lock for the metal cut key.



Smart Key System (Optional Equipment - Continued)

Back Door (Lock/Unlock)

Using the following methods will lock/unlock back door.

- Pushing  on the wireless smart key locks all doors, including the back door.
- Pushing the back door lock button (see illustration) will lock all doors, including the back door.
- Pushing  on the wireless smart key twice unlocks all doors, including the back door.
- Touching the back door opener switch (see illustration) with the smart key in proximity to the back door will unlock/open the back door.

Optional Power Back Door (Open/Close)

Various methods are available to open/close the optional power back door.

- Pushing and holding  on the wireless smart key will open/close the optional power back door.
- Pushing the power back door switch on the instrument panel will open/close the power back door.
- Pushing the power back door closer switch (see illustration) located on the bottom of the door will close the power door.

NOTE:

If the power back door cancel switch is activated the power back door will not function.

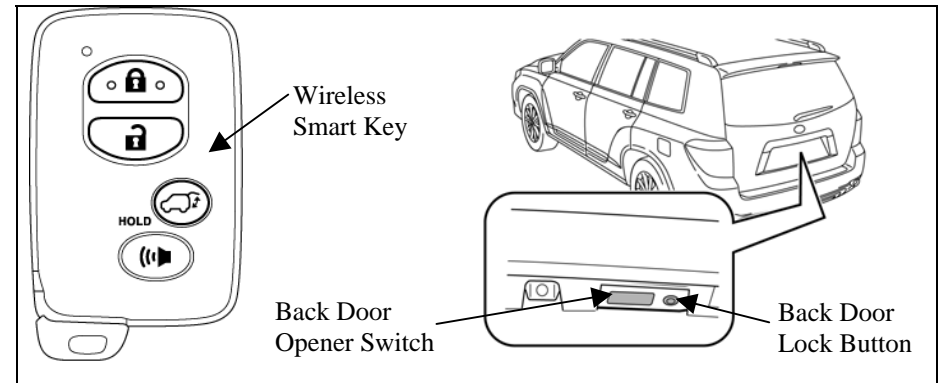

Back Door Lock Button and Opener Switch

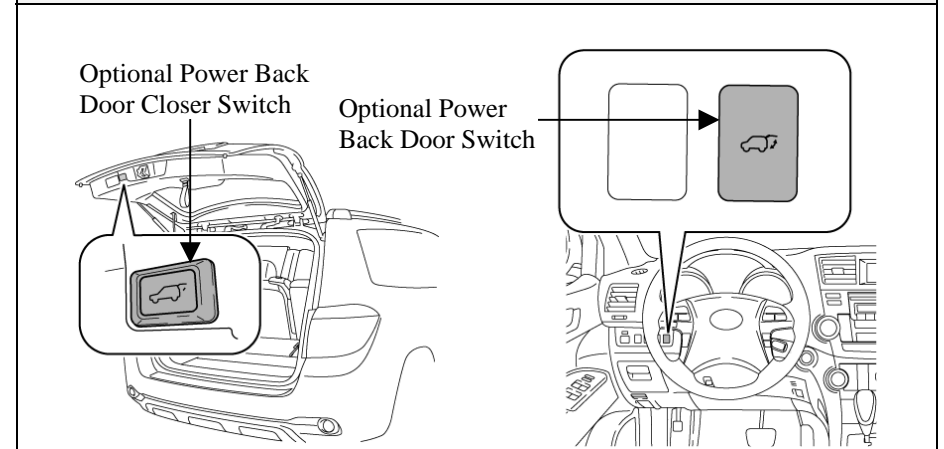

Optional Power Back Door Switches

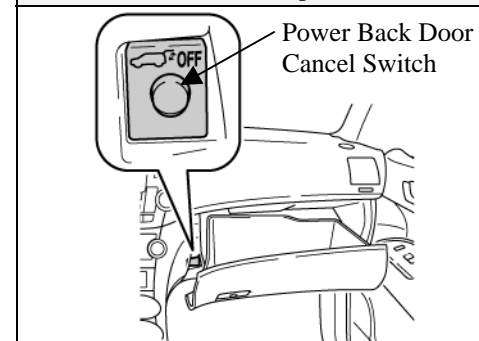

Power Back Door Cancel Switch

Smart Key System (Optional Equipment - Continued)

Optional Glass Hatch (Unlock/Open)

The optional glass hatch can be unlocked/opened two ways:

1. When the vehicle is unlocked, pushing the glass hatch opener button (see illustration) on the back door will open the glass hatch.
2. When the vehicle is locked, with the smart key in proximity to the back door, pushing the glass hatch opener button once will unlock and open the glass hatch.

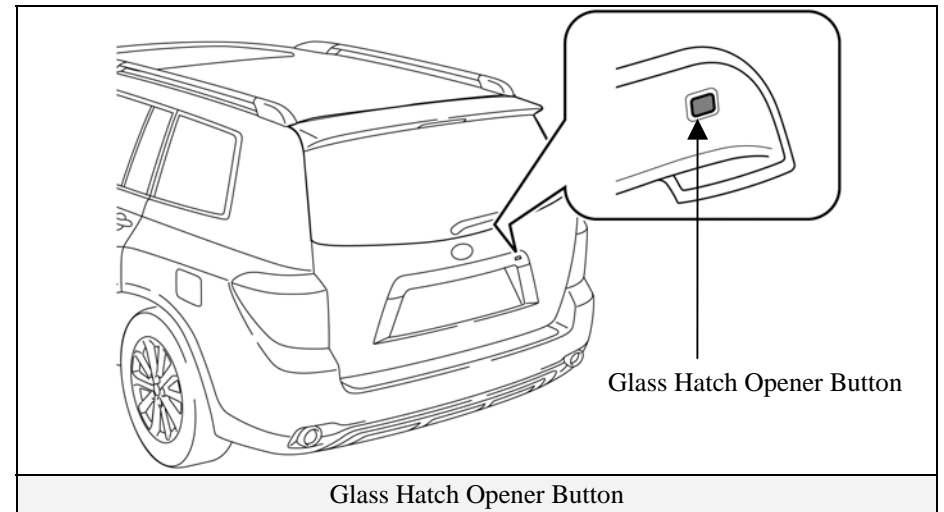

Smart Key System (Optional Equipment - Continued)

Vehicle Starting/Stopping

The smart key has replaced the conventional metal cut key, and the power button with an integral status indicator light has replaced the ignition switch. The smart key only needs to be in proximity to the vehicle to allow the system to function.

- With the brake pedal released, the first push of the power button operates the accessory mode, the second push operates the ignition-on mode, and the third push turns the ignition off again.

Ignition Mode Sequence (brake pedal released):

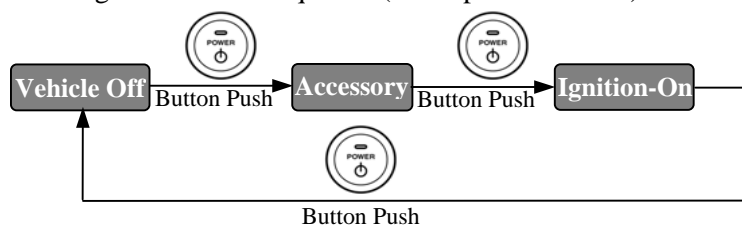

- Starting the vehicle takes priority over all other ignition modes and is accomplished by depressing the brake pedal and pushing the power button once. To verify the vehicle has started, check that the power button status indicator light is off and the **READY** light is illuminated in the instrument cluster.
- If the internal smart key battery is dead, use the following method to start the vehicle.
 - Touch the Toyota emblem side of the smart key to the power button.
 - Within the 5 seconds after the buzzer sounds, push the power button with the brake pedal depressed (the **READY** light will illuminate).
- Once the vehicle has started and is on and operational (**READY-ON**), the vehicle is shut off by bringing the vehicle to a complete stop, placing the gearshift lever in park (**P**), and then depressing the power button once.
- To shut off the vehicle before coming to a stop in an emergency, push and hold down the power button for more than 3 seconds. This procedure may be useful such as at an accident scene in which the **READY** indicator is on and the drive wheels remain in motion.

Ignition Mode	Power Button Indicator Light
Off	Off
Accessory	Amber
Ignition-On	Amber
Brake Pedal Depressed	Green
Vehicle Started (READY-ON)	Off
Malfunction	Blinking Amber

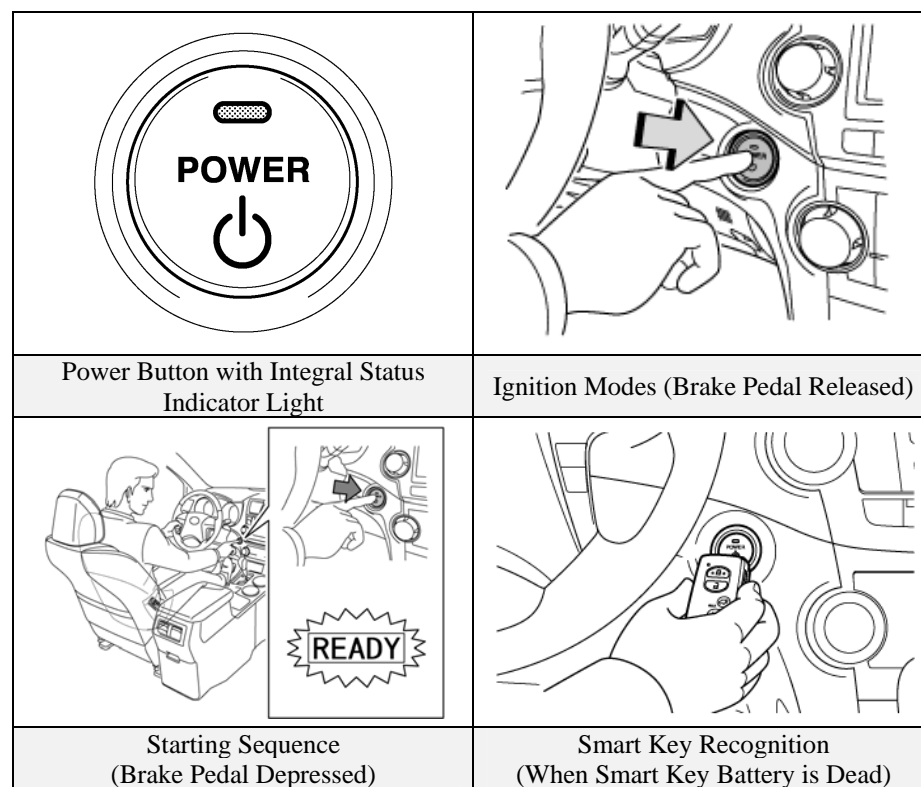

Hybrid Synergy Drive Operation

Once the **READY** indicator is illuminated in the instrument cluster, the vehicle may be driven. However, the gasoline engine does not idle like a typical automobile and will start and stop automatically. It is important to recognize and understand the **READY** indicator provided in the instrument cluster. When lit, it informs the driver that the vehicle is on and operational even though the gasoline engine may be off and the engine compartment is silent.

Vehicle Operation

- With the Highlander hybrid, the gasoline engine may stop and start at any time while the **READY** indicator is on.
- Never assume that the vehicle is shut off just because the engine is off. Always look for the **READY** indicator status. The vehicle is shut off when the **READY** indicator is off.
- The vehicle may be powered by:
 1. The electric motors only.
 2. The gasoline engine only.
 3. A combination of both the electric motors and the gasoline engine.
- The vehicle computer determines the mode in which the vehicle operates in order to improve fuel economy and reduce emissions. Two new features on the 2008 Highlander hybrid are EV (Electric Vehicle) drive mode and ECON (Economy) drive mode:
 1. EV Drive Mode: When activated, and certain conditions have been met, the vehicle operates with the electric motor powered by the HV battery.
 2. Economy Drive Mode: When activated, this mode helps enhance fuel economy on trips that involve frequent braking and acceleration.

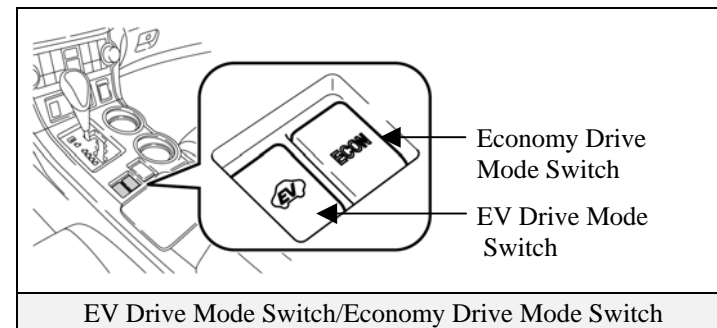
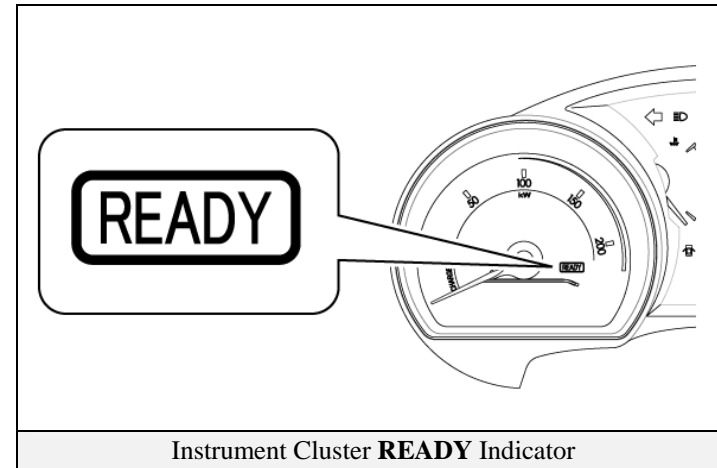

Hybrid Vehicle (HV) Battery Pack

The Highlander hybrid features a high voltage Hybrid Vehicle (HV) battery pack that contains sealed Nickel Metal Hydride (NiMH) battery modules.

HV Battery Pack

- The HV battery pack is enclosed in a metal case and is rigidly mounted to the cabin area floor pan cross member under the second row rear seat. The metal case is isolated from high voltage and concealed by carpet in the cabin area.
- The HV battery pack consists of 30 low voltage (9.6 Volt) NiMH battery modules connected in series to produce approximately 288 Volts. Each NiMH battery module is non-spillable and sealed in a metal case.
- The electrolyte used in the NiMH battery module is an alkaline mixture of potassium and sodium hydroxide. The electrolyte is absorbed into the battery cell plates and will not normally leak, even in a collision.
- In the unlikely event that the battery pack is overcharged, the modules vent gases directly outside the vehicle through a vent hose.

HV Battery Pack	
Battery pack voltage	288 V
Number of NiMH battery modules in the pack	30
NiMH battery module voltage	9.6 V
NiMH battery module dimensions	1 x 15 x 3.3 in (18.5 x 382 x 86 mm)
NiMH module weight	3.3 lbs (1.5 kg)
NiMH battery pack dimensions	25 x 43 x 7 in (630 x 1080 x 180 mm)
NiMH battery pack weight	152.1 lbs (69 kg)

Components Powered by the HV Battery Pack

- Front Electric Motor
- Inverter/Converter
- A/C Compressor
- Rear Electric Motor
- Power Cables
- Electric Generator

HV Battery Pack Recycling

- The HV battery pack is recyclable. Contact the nearest Toyota dealer or:

United States: (800) 331-4331

Canada: (888) TOYOTA 8 [(888) 869-6828]

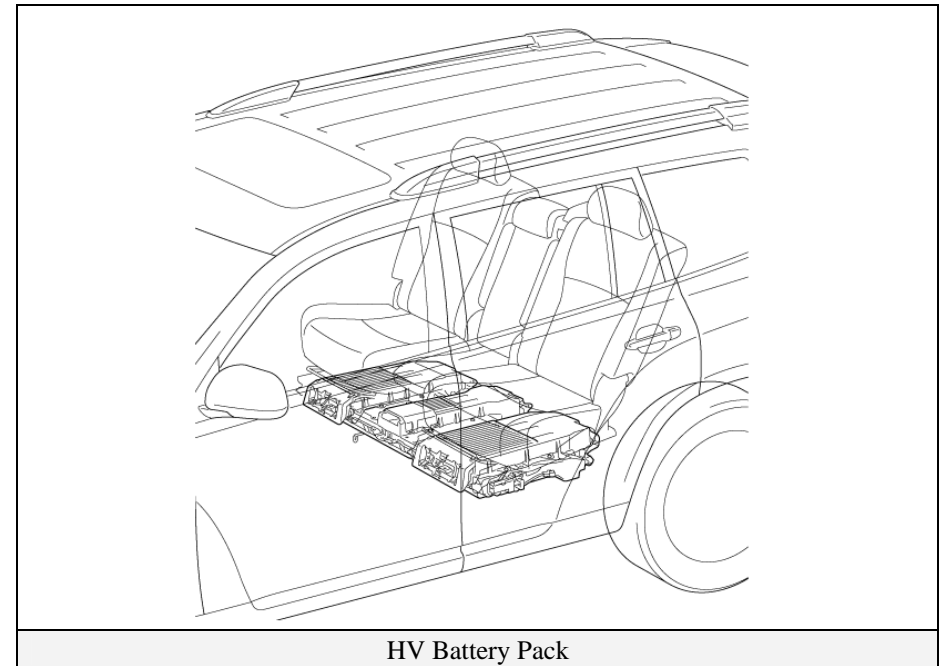

Low Voltage Battery

Auxiliary Battery

- The Highlander hybrid contains a lead-acid 12 Volt auxiliary battery. The 12 Volt auxiliary battery powers the vehicle's electrical system similar to a conventional vehicle. As with conventional vehicles, the negative terminal of the auxiliary battery is grounded to the metal chassis of the vehicle.
- For 2008 - 2010 models, the auxiliary battery is located in the engine compartment.
- For the 2011 model, the auxiliary battery is located in the cargo area. It is concealed by a battery cover on the driver side of the vehicle.

NOTE:

An under hood label shows the location of the HV battery (traction battery) and 12 Volt auxiliary battery.

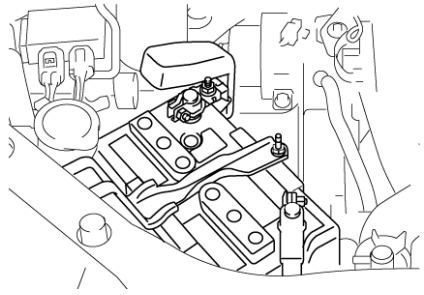

12 Volt Auxiliary Battery Mounted in Engine Compartment (2008 - 2010 Models)

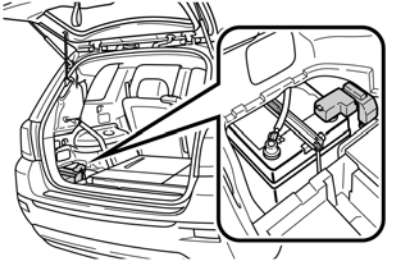

12 Volt Auxiliary Battery Mounted in Cargo Area (2011 Model)

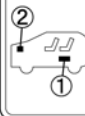
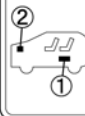
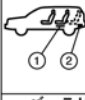
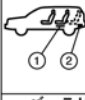
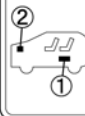
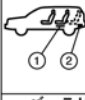
2008 – 2010 Models	2011 Model												
<table border="1" style="width: 100%; border-collapse: collapse;"> <thead> <tr> <th style="width: 30%;">BATTERY LOCATION</th> <th style="width: 35%;">EMPLACEMENT DES BATTERIES</th> </tr> </thead> <tbody> <tr> <td style="text-align: center;">  </td> <td> <p>This vehicle has two types of battery:</p> <p>① Nickel-Metal Hydride Battery (Traction Battery)</p> <p>② Lead Acid Battery (Auxiliary Battery for accessories, lights, etc.)</p> </td> </tr> <tr> <td></td> <td> <p>Ce véhicule est équipé de deux types de batteries:</p> <p>① Batterie à l'hydruure de nickel métallique (batterie de traction)</p> <p>② Batterie à acide et plomb (Batterie auxiliaire pour les feux, les accessoires, etc.)</p> </td> </tr> </tbody> </table>	BATTERY LOCATION	EMPLACEMENT DES BATTERIES		<p>This vehicle has two types of battery:</p> <p>① Nickel-Metal Hydride Battery (Traction Battery)</p> <p>② Lead Acid Battery (Auxiliary Battery for accessories, lights, etc.)</p>		<p>Ce véhicule est équipé de deux types de batteries:</p> <p>① Batterie à l'hydruure de nickel métallique (batterie de traction)</p> <p>② Batterie à acide et plomb (Batterie auxiliaire pour les feux, les accessoires, etc.)</p>	<table border="1" style="width: 100%; border-collapse: collapse;"> <thead> <tr> <th style="width: 30%;">BATTERY LOCATION</th> <th style="width: 35%;">EMPLACEMENT DES BATTERIES</th> </tr> </thead> <tbody> <tr> <td style="text-align: center;">  </td> <td> <p>This vehicle has two types of battery:</p> <p>① Nickel-Metal Hydride Battery (Traction Battery)</p> <p>② Lead Acid Battery (Auxiliary Battery for accessories, lights, etc.)</p> </td> </tr> <tr> <td></td> <td> <p>Ce véhicule est équipé de deux types de batteries:</p> <p>① Batterie à l'hydruure de nickel métallique (Batterie de traction)</p> <p>② Batterie à acide et plomb (Batterie auxiliaire pour les feux, les accessoires, etc.)</p> </td> </tr> </tbody> </table>	BATTERY LOCATION	EMPLACEMENT DES BATTERIES		<p>This vehicle has two types of battery:</p> <p>① Nickel-Metal Hydride Battery (Traction Battery)</p> <p>② Lead Acid Battery (Auxiliary Battery for accessories, lights, etc.)</p>		<p>Ce véhicule est équipé de deux types de batteries:</p> <p>① Batterie à l'hydruure de nickel métallique (Batterie de traction)</p> <p>② Batterie à acide et plomb (Batterie auxiliaire pour les feux, les accessoires, etc.)</p>
BATTERY LOCATION	EMPLACEMENT DES BATTERIES												
	<p>This vehicle has two types of battery:</p> <p>① Nickel-Metal Hydride Battery (Traction Battery)</p> <p>② Lead Acid Battery (Auxiliary Battery for accessories, lights, etc.)</p>												
	<p>Ce véhicule est équipé de deux types de batteries:</p> <p>① Batterie à l'hydruure de nickel métallique (batterie de traction)</p> <p>② Batterie à acide et plomb (Batterie auxiliaire pour les feux, les accessoires, etc.)</p>												
BATTERY LOCATION	EMPLACEMENT DES BATTERIES												
	<p>This vehicle has two types of battery:</p> <p>① Nickel-Metal Hydride Battery (Traction Battery)</p> <p>② Lead Acid Battery (Auxiliary Battery for accessories, lights, etc.)</p>												
	<p>Ce véhicule est équipé de deux types de batteries:</p> <p>① Batterie à l'hydruure de nickel métallique (Batterie de traction)</p> <p>② Batterie à acide et plomb (Batterie auxiliaire pour les feux, les accessoires, etc.)</p>												
<p>バッテリー搭載位置 インフォメーション</p> <p>この車には次のバッテリーが搭載されています。</p> <p>① ニッケル・水素バッテリー (駆動用)</p> <p>② 鉛バッテリー (ランプ、アクセサリ等の補機作動用)</p>	<p>蓄電池位置</p> <p>此車輛有兩種典型的蓄電池</p> <p>① 镍氢混合动力車專用蓄電池 (牽引用蓄電池)</p> <p>② 鉛酸蓄電池 (供附屬設備和照明使用的輔助用蓄電池)</p>												

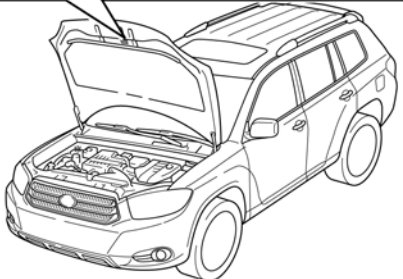

Battery Location Label

SRS Airbags & Seat Belt Pretensioners

Standard Equipment

- Electronic frontal impact sensors (2) are mounted in the engine compartment ❶ as illustrated.
- Front seat belt pretensioners are mounted near the base of the B-pillars ❷.
- A frontal dual stage driver airbag ❸ is mounted in the steering wheel hub.
- A frontal dual stage passenger airbag ❹ is integrated into the dashboard and deploys through the dashboard.
- The SRS computer ❺, which contains an impact sensor, is mounted on the floor pan underneath the instrument panel, forward of the shift lever.
- Front electronic side impact sensors (2) are mounted near the base of the B-pillars ❻.
- Rear electronic side impact sensors (2) are mounted near the base of the C-pillars ❼.
- Front seat side airbags ❸ are mounted in the seatbacks.
- Side curtain airbags ❹ are mounted along the outer edge inside the roof rails.
- A front knee airbag ❷ is mounted on the driver side lower portion of the dash.
- Front door electronic side impact sensors (2) are mounted inside the base of the front doors ❶ (2011 Model).
- Active (mechanical non-pyrotechnic) front seat headrests (see description on page 26).

WARNING:

The SRS may remain powered for up to 90 seconds after the vehicle is shut off or disabled. To prevent serious injury or death from unintentional SRS deployment, avoid breaching the SRS components.

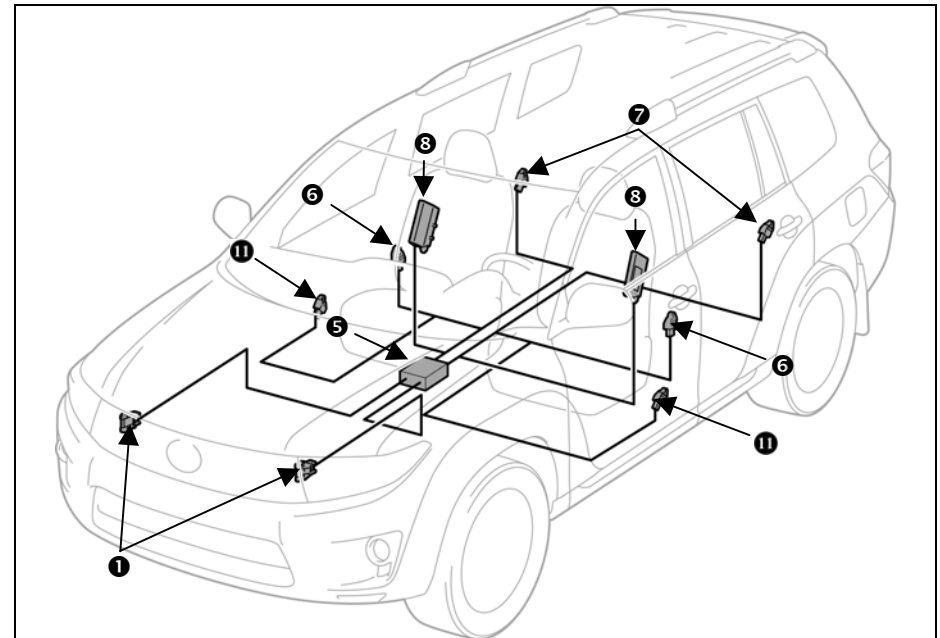

Electronic Impact Sensors and Front Seat Side Airbags

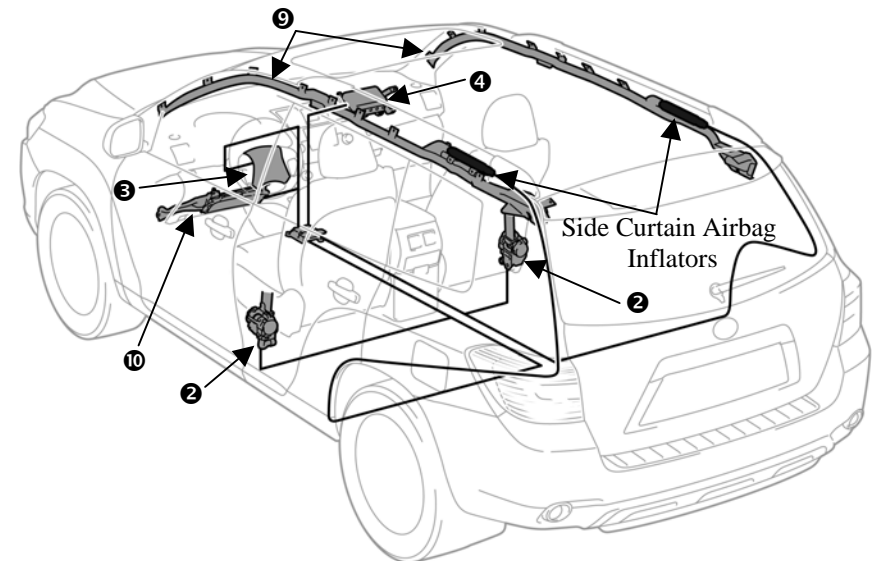

Standard Frontal Airbags, Seat Belt Pretensioners, Knee Airbag, Side Curtain Airbags

SRS Airbags & Seat Belt Pretensioners (Continued)

Standard Equipment (Continued)

NOTE:

The front seatback mounted side airbags and the side curtain airbags may deploy independently of each other.

The knee airbag (driver side only) deploys simultaneously with the frontal airbags and seat belt pretensioners.

The Highlander hybrid is equipped with a standard front passenger occupant classification system that may prohibit the deployment of the front passenger frontal airbag, seatback mounted side airbag, and seat belt pretensioner. If the passenger occupant classification system prohibits deployment during an SRS event, the passenger SRS will not re-arm nor deploy.

Beginning with the 2011 model, an electronic side impact sensor, installed in each front door, has been added to the SRS airbag system to aid in side collision detection accuracy.

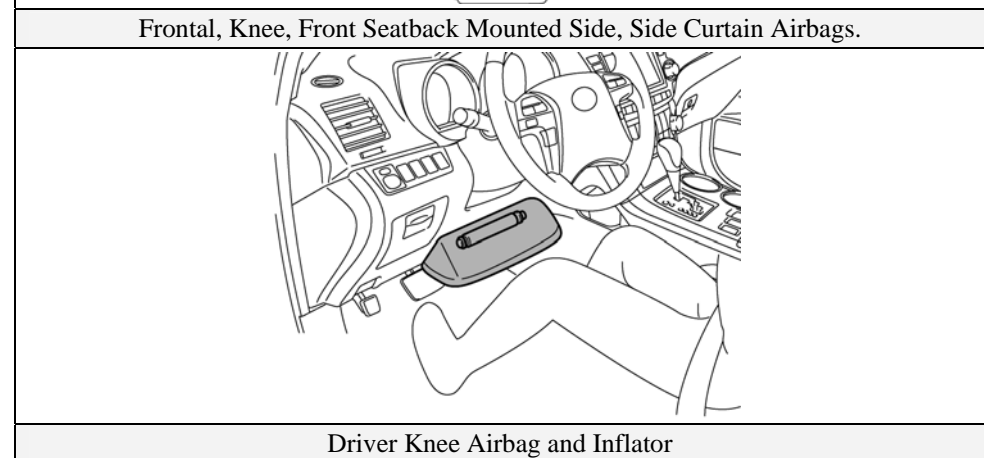
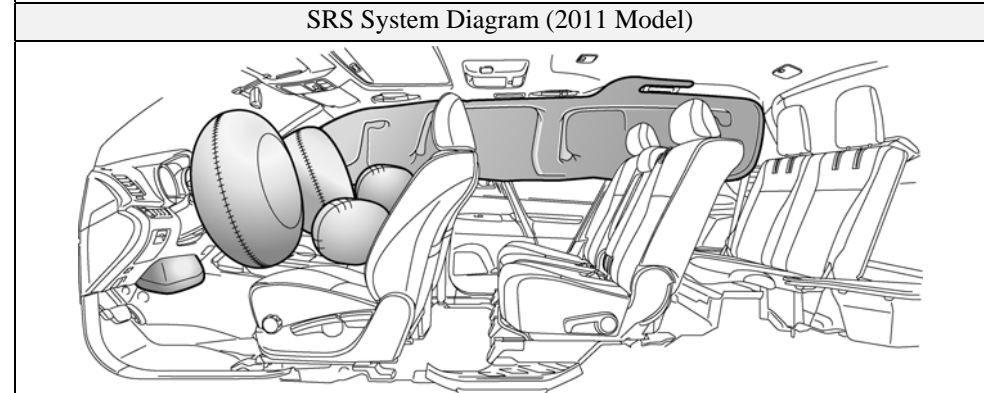
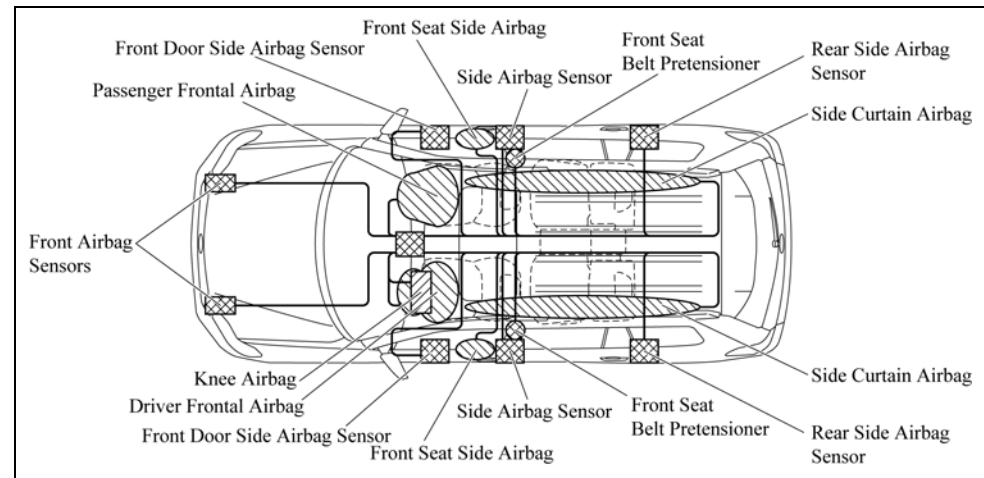
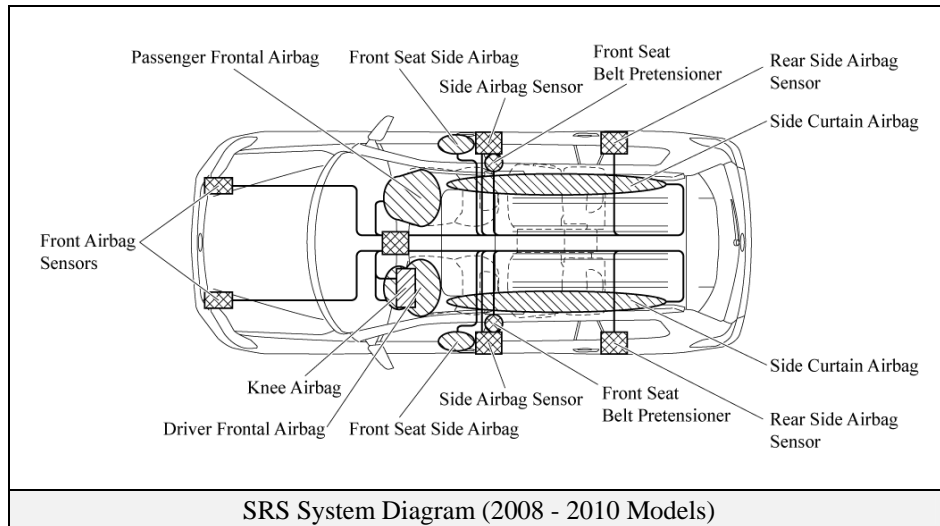

Emergency Response

On arrival, emergency responders should follow their standard operating procedures for vehicle incidents. Emergencies involving the Highlander hybrid may be handled like other automobiles except as noted in these guidelines for Extrication, Fire, Overhaul, Recovery, Spills, First Aid, and Submersion.

WARNING:

- *Never assume the Highlander hybrid is shut off simply because it is silent.*
- *Always observe the instrument cluster for the **READY** indicator status to verify whether the vehicle is on or shut off. The vehicle is shut off when the **READY** indicator is off.*
- *Failure to shut off the vehicle before emergency response procedures are performed may result in serious injury or death from the unintentional deployment of the SRS or severe burns and electric shock from the high voltage electrical system.*

Extrication

- **Immobilize Vehicle**
Chock wheels and set the parking brake.
Move the shift lever to park (**P**).
- **Disable Vehicle**
Performing either of the following two procedures will shut the vehicle off and disable the HV battery pack, SRS, and gasoline fuel pump.

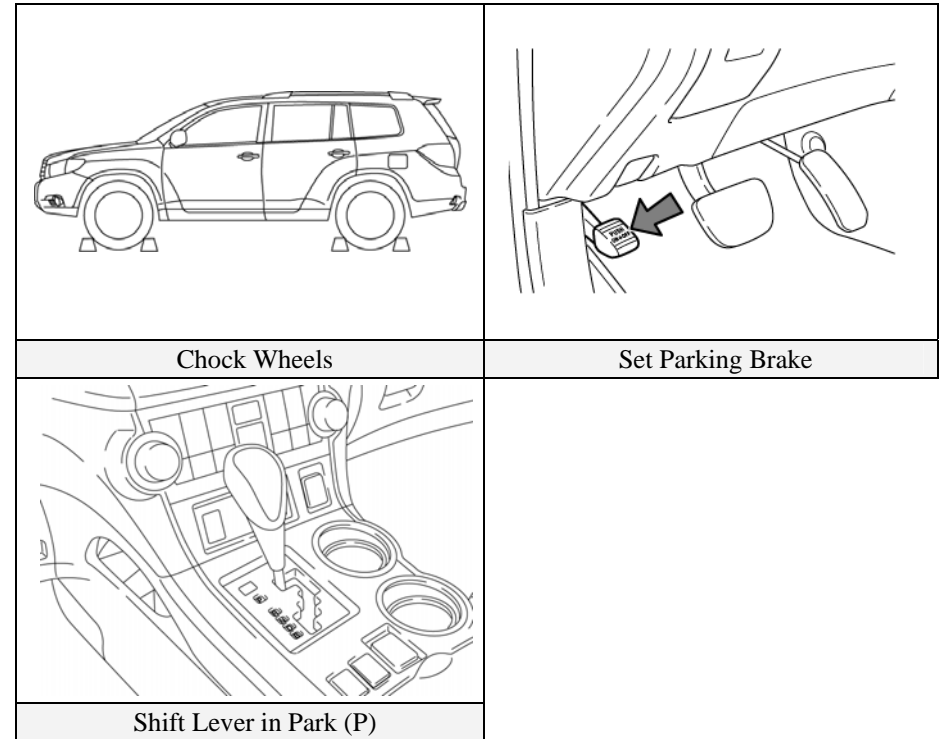

Emergency Response (Continued)

Extrication (Continued)

Procedure #1

Smart Key System:

(Standard on 2008 - 2010 Models & Optional on 2011 Model)

1. Confirm the status of the **READY** indicator in the instrument cluster.
2. If the **READY** indicator is illuminated, the vehicle is on and operational. Shut off the vehicle by pushing the power button once.
3. The vehicle is already shut off if the instrument cluster lights and the **READY** indicator are not illuminated. Do **not** push the power button because the vehicle may start.
4. If the smart key is easily accessible, keep it at least 16 feet (5 meters) away from the vehicle.
5. If the smart key cannot be found, disconnect the 12 Volt auxiliary battery to prevent accidental restarting of the vehicle.

Auxiliary battery location:

- Engine compartment (2008 - 2010 Models)
- Cargo area (2011 Model)

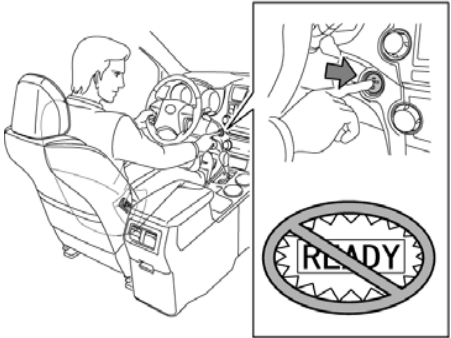
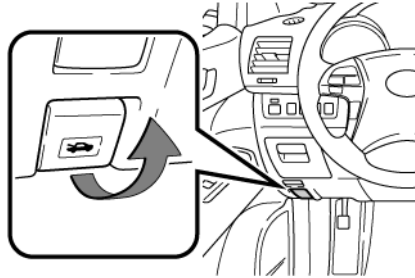
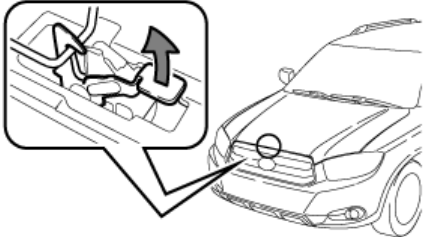
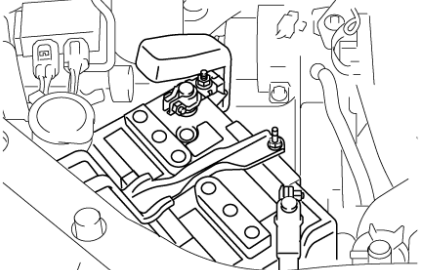
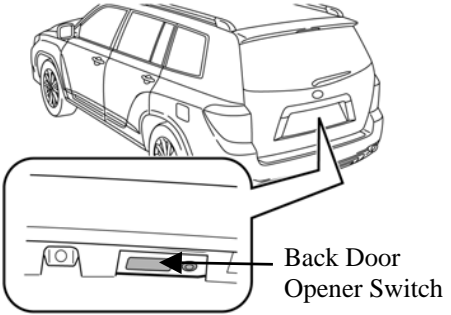
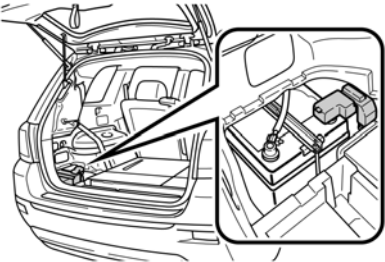
	
<p>Shut Off Vehicle (READY-OFF)</p>	<p>Remote Hood Release</p>
	
<p>Hood Latch Release</p>	<p>Volt Auxiliary Battery in Engine Compartment (2008 - 2010 Models)</p>
	
<p>Back Door Opener Switch</p>	<p>12 Volt Auxiliary Battery in Cargo Area (2011 Model)</p>

Emergency Response (Continued)

Extrication (Continued)

Mechanical Ignition Key System: (Standard on 2011 Model)

1. Confirm the status of the **READY** indicator in the instrument cluster.
2. If the **READY** indicator is illuminated, the vehicle is on and operational. Shut off the vehicle by turning the ignition key off, removing the ignition key and placing it on the dash.
3. Disconnect the 12 Volt auxiliary battery in the cargo area to prevent accidental restarting of the vehicle.

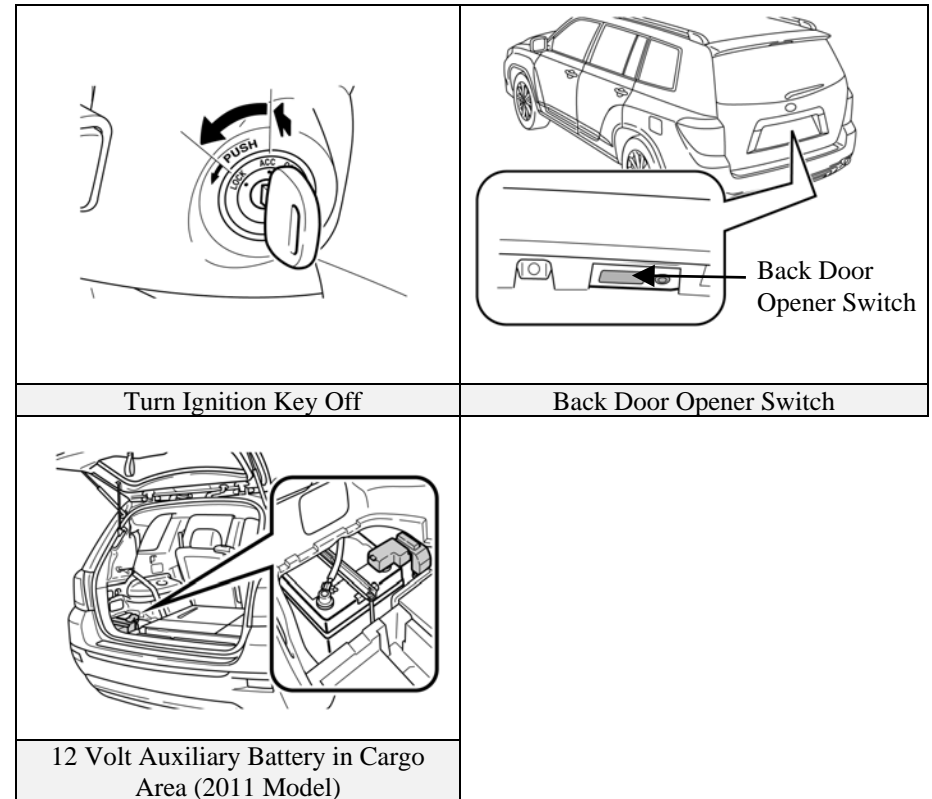

Emergency Response (Continued)

Extrication (Continued)

Procedure #2 (Alternate if power button or ignition key is inaccessible)

1. Remove the fuse box cover.
2. Remove the appropriate fuse in the engine compartment fuse box as illustrated.
 - 30A green IGCT fuse (2008 - 2010 Models)
 - 30A green IG2 Main fuse (2011 Model)

If the correct fuse cannot be recognized, pull all fuses in the fuse box.
3. Disconnect the 12 Volt auxiliary battery.

Auxiliary battery location:

 - Engine compartment (2008 - 2010 Models)
 - Cargo area (2011 Model)

NOTE:

Before disconnecting the 12 Volt auxiliary battery, if necessary, reposition the power seats, lower the windows, unlock the doors, open the back door and the fuel door as required. A manual fuel door release is located behind a panel in the driver side of the cargo area (see the illustration in the Roadside Assistance section on page 32). Once the 12 Volt auxiliary battery is disconnected, power controls will not operate.

⚠ WARNING:

- *The high voltage system may remain powered for up to 10 minutes after the vehicle is shut off or disabled. To prevent serious injury or death from severe burns or electric shock, avoid touching, cutting, or breaching any orange high voltage power cable or high voltage component.*
- *The SRS may remain powered for up to 90 seconds after the vehicle is shut off or disabled. To prevent serious injury or death from unintentional SRS deployment, avoid breaching the SRS components.*
- *If none of the disabling procedures can be performed, proceed with caution as there is no assurance that the high voltage electrical system, SRS, or fuel pump are disabled.*

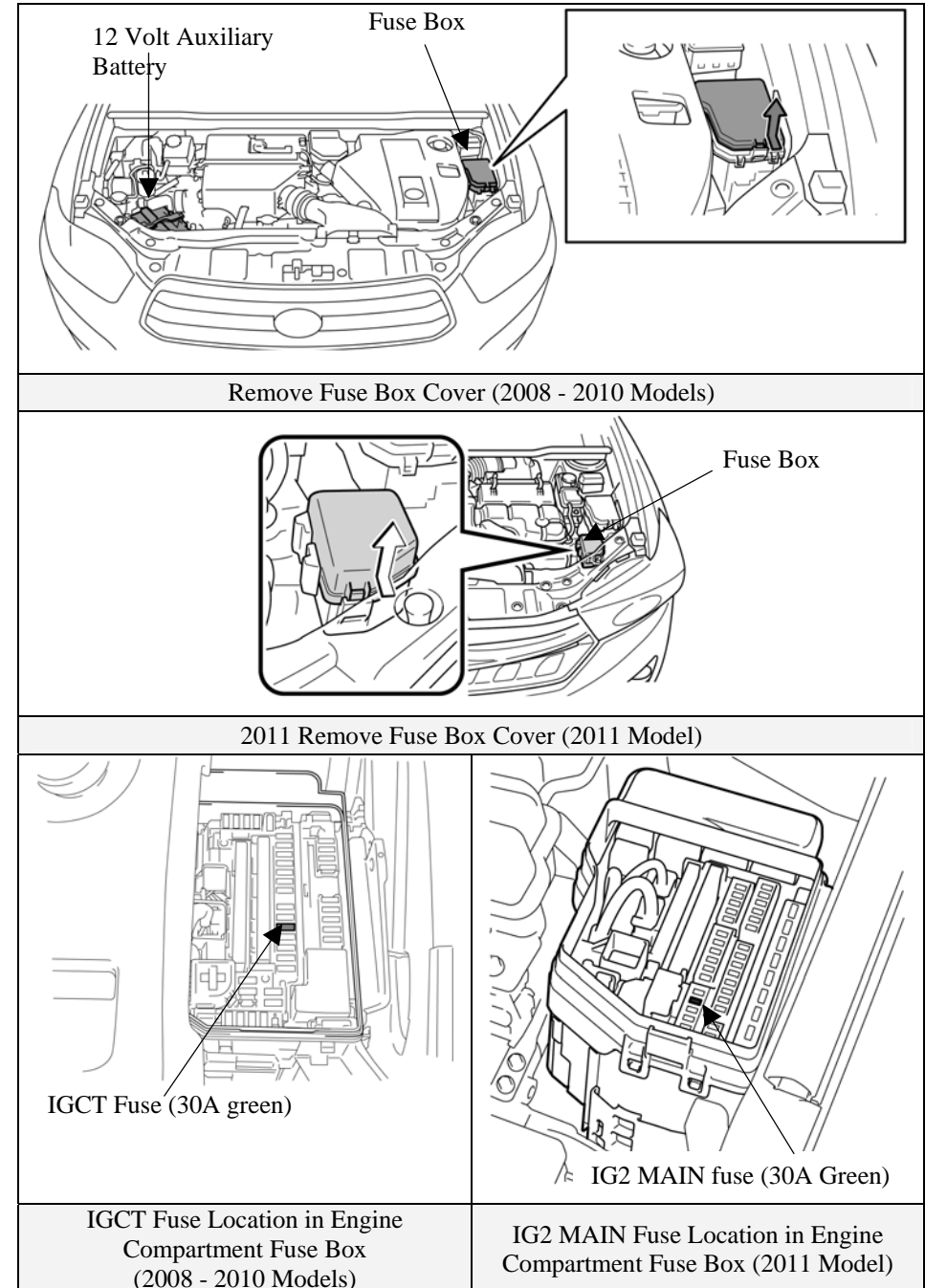

Emergency Response (Continued)

Extrication (Continued)

- Stabilize Vehicle

Crib at (4) points directly under the front and rear pillars.
Do not place cribbing under the high voltage power cables, exhaust system, or fuel system.

NOTE:

The Highlander hybrid is equipped with a tire pressure warning system that by design prevents pulling the metal valve stem with integral transmitter from the wheel. Snapping the valve stem with pliers or removing the valve cap and Schrader valve will release the air in the tire.

- Access Patients

Glass Removal

Use normal glass removal procedures as required.

SRS Awareness

Responders need to be cautious when working in close proximity to undeployed airbags and seat belt pretensioners. Front dual stage airbags automatically ignite both stages within a fraction of a second.

Door Removal/Displacement

Doors can be removed by conventional rescue tools such as hand, electric, and hydraulic tools. In certain situations, it may be easier to pry back the vehicle body to expose and unbolt the hinges.

NOTE:

Beginning with the 2011 model, the Highlander hybrid is equipped with an electronic impact sensor mounted in both front doors. During door removal, cutting the wiring harness routed to the front door will not result in airbag deployment.

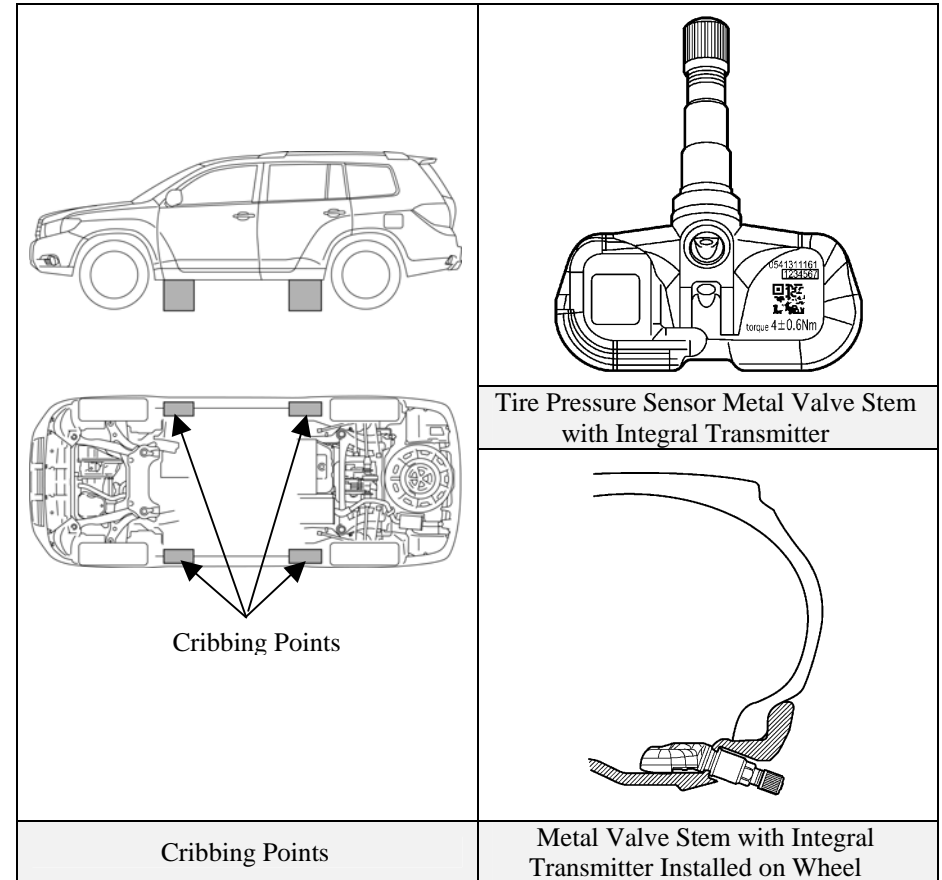

Emergency Response (Continued)

Extrication (Continued)

Roof Removal

The Highlander hybrid is equipped with side curtain airbags. When undeployed, total roof removal is not recommended. Patient access through the roof can be performed by cutting the roof center section inboard of the roof rails as illustrated. This would avoid breaching the side curtain airbags, inflators, and wiring harness.

NOTE:

The side curtain airbags may be identified as illustrated on this page (additional component details on page 17).

Dash Displacement

The Highlander hybrid is equipped with side curtain airbags. When undeployed, total roof removal is not recommended to avoid breaching the side curtain airbags, inflators, and wiring harness. As an alternative, dash displacement may be performed by using a Modified Dash Roll.

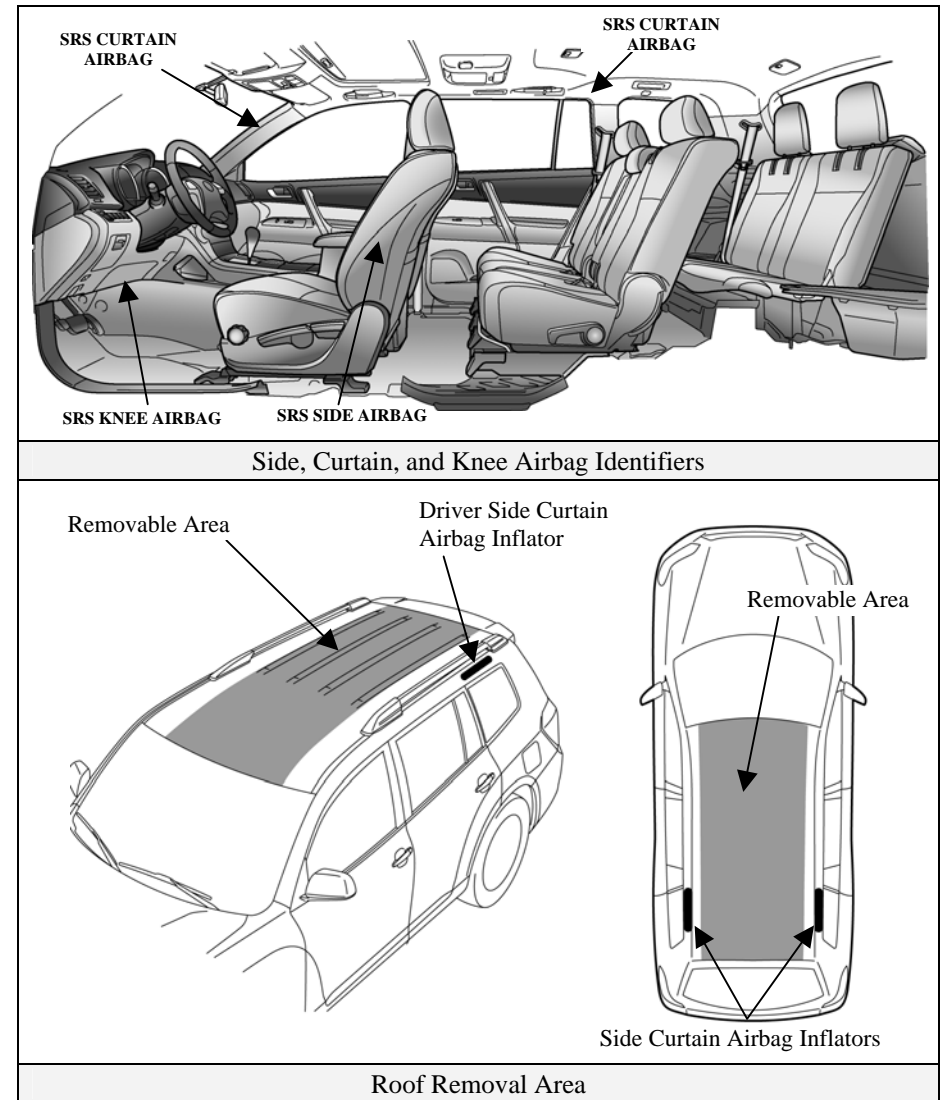

Emergency Response (Continued)

Extrication (Continued)

Rescue Lift Air Bags

Responders should not place cribbing or rescue lift air bags under the high voltage power cables, exhaust system, or fuel system.

Repositioning Steering Wheel and Front Seats

Telescopic steering wheel and seat controls are shown in the illustrations.

NOTE:

The Highlander hybrid is equipped with an optional power driver seat leg support adjustment. The length of the cushion pad can be adjusted by raising or lowering the front portion of the driver seat cushion in the event of a dashboard entrapment. The control switch for the optional leg support adjustment is located to the far left on the power seat panel.

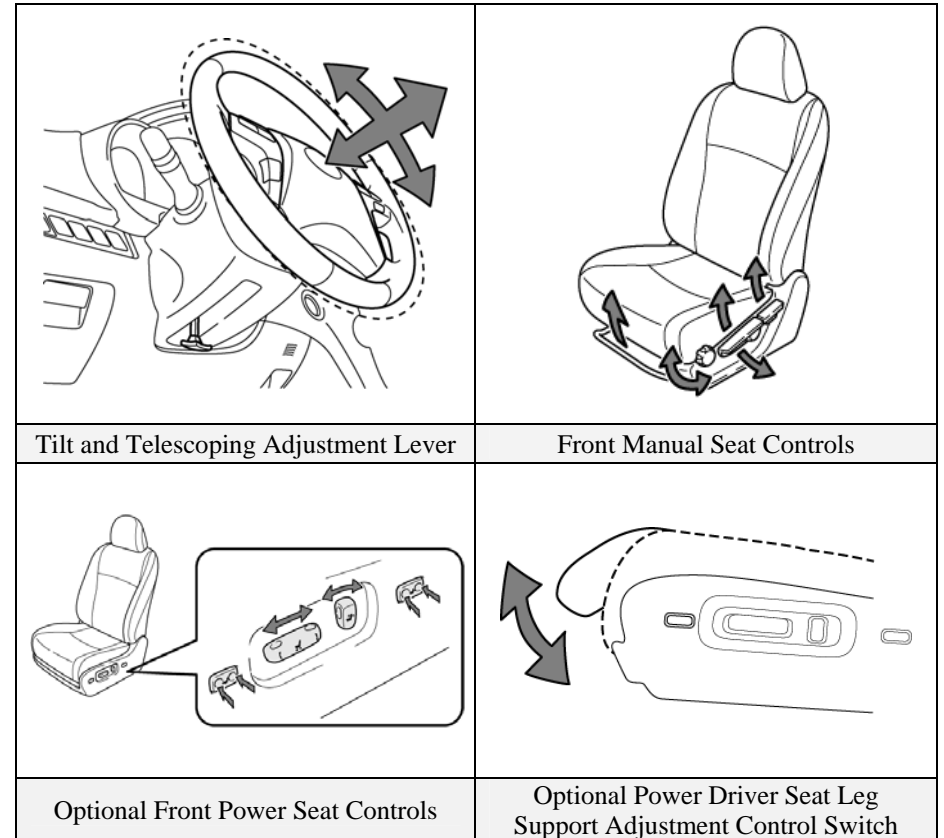

Emergency Response (Continued)

Extrication (Continued)

Active Headrest Removal

The Highlander hybrid is equipped with active headrests, located in both front seatbacks. The active headrests are mechanical non-pyrotechnic head supports that are designed to reduce neck injuries in the event of a rear collision.

Active headrest removal procedure:

- To remove the active headrest, squeeze the left headrest lock button (see illustration) located on the top of the seat, insert a flat head screwdriver into the right hand release slot and lift the headrest up and out (2008 - 2010 Models).
- To remove the active headrest, squeeze the headrest lock button and pull the headrest up and out (2011 Model).

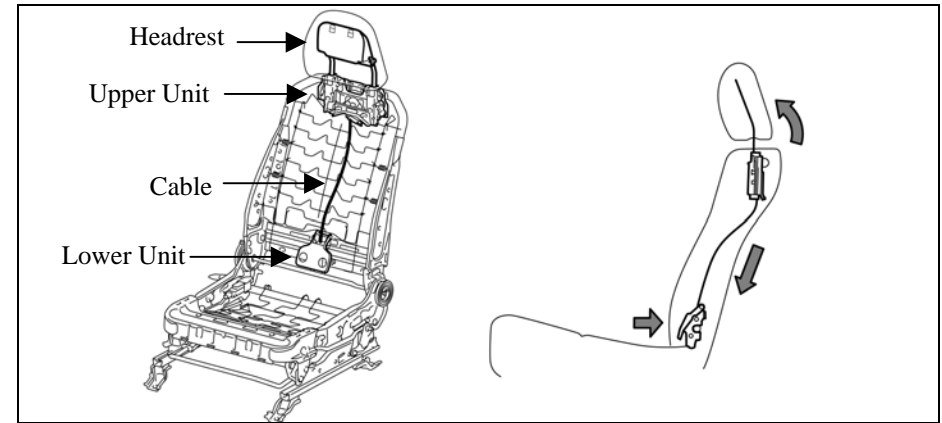

Front Active Headrest

Headrest Removal (Second and Optional Third Row)

- The headrests for the outer second row seats can be removed using the same process as described above for the front headrests (2008 - 2010 Models).
- The headrests for the outer second row seats can be removed by squeezing the headrest lock button and pulling the headrest up and out (2011 Model).
- The headrest for the second row center seat can be removed in a conventional manner by squeezing the lock button and lifting the headrest up and out (All Models).

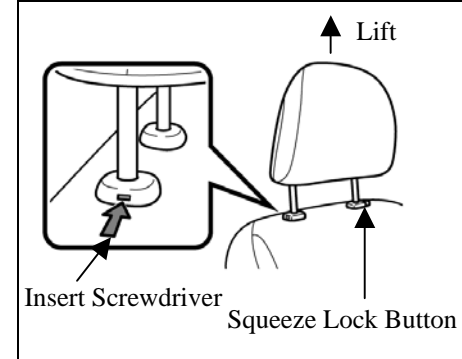

Headrest Removal Slot (2008 - 2010 Models)

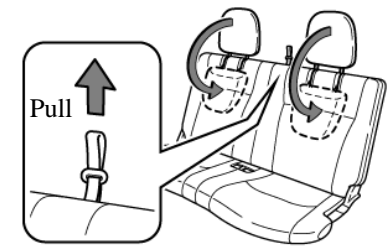

Optional Third Row Forward Folding Headrests

The forward folding headrests for the optional third row seat are not removable.

NOTE:

The Highlander hybrid may be equipped with an optional electrochromic auto dimming rear view mirror. The mirror contains a minimal amount of transparent gel sealed between two glass plates that will not normally leak.

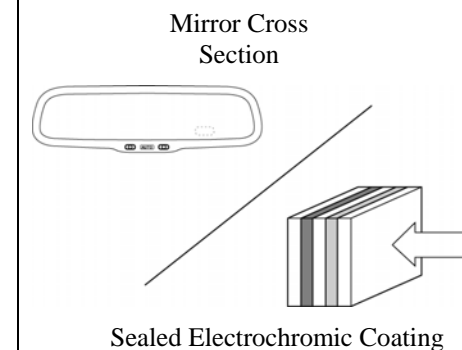

Optional Electrochromic Auto Dimming Mirror

Emergency Response (Continued)

Fire

Approach and extinguish a fire using proper vehicle fire fighting practices as recommended by NFPA, IFSTA, or the National Fire Academy (USA).

- Extinguishing Agent
Water has been proven to be a suitable extinguishing agent.
- Initial Fire Attack
Perform a fast, aggressive fire attack.
Divert the runoff from entering watershed areas.
Attack teams may not be able to identify a Highlander hybrid until the fire has been knocked down and overhaul operations have commenced.
- Fire in the HV Battery Pack
Should a fire occur in the NiMH HV battery pack, attack crews should utilize a water stream or fog pattern to extinguish any fire within the vehicle except for the HV battery pack.

WARNING:

- *The NiMH battery electrolyte is a caustic alkaline (pH 13.5) that is damaging to human tissues. To avoid injury by coming in contact with the electrolyte, wear proper personal protective equipment.*
- *The battery modules are contained within a metal case and accessibility is limited.*
- *To avoid serious injury or death from severe burns or electric shock, **never** breach or remove the high voltage battery pack cover under any circumstance including fire.*

When allowed to burn themselves out, the Highlander hybrid NiMH battery modules burn rapidly and can quickly be reduced to ashes except for the metal.

Offensive Fire Attack

Normally, flooding an NiMH HV battery pack with copious amounts of water at a safe distance will effectively control the HV battery pack fire by cooling the adjacent NiMH battery modules to a point below their ignition temperature. The remaining modules on fire, if not extinguished by the water, will burn themselves out.

However, flooding the Highlander HV battery pack is not recommended due to the battery case design and location preventing the responder from properly applying water through the available vent openings safely. Therefore, it is recommended that the incident commander allow the Highlander HV battery pack to burn itself out.

Defensive Fire Attack

If the decision has been made to fight the fire using a defensive attack, the fire attack crew should pull back a safe distance and allow the NiMH battery modules to burn themselves out. During this defensive operation, fire crews may utilize a water stream or fog pattern to protect exposures or to control the path of smoke.

Emergency Response (Continued)

Overhaul

During overhaul, immobilize and disable the vehicle if not already done. Refer to illustrations on page 19, 20, 21 and 22. The HV battery cover should *never* be breached or removed under any circumstances including fire. Doing so may result in severe electrical burns, shock, or electrocution.

- Immobilize Vehicle
 - Chock wheels and set the parking brake.
 - Move the shift lever to park (P).
- Disable Vehicle
 - Performing either of the following two procedures will shut the vehicle off and disable the HV battery pack, SRS, and gasoline fuel pump.

Procedure #1

Smart Key System:

(Standard on 2008 - 2010 Models & Optional on 2011 Model)

1. Confirm the status of the **READY** indicator in the instrument cluster.
2. If the **READY** indicator is illuminated, the vehicle is on and operational. Shut off the vehicle by pushing the power button once.
3. The vehicle is already shut off if the instrument cluster lights and the **READY** indicator are not illuminated. Do **not** push the power button because the vehicle may start.
4. If the smart key is easily accessible, keep it at least 16 feet (5 meters) away from the vehicle.
5. If the smart key cannot be found, disconnect the 12 Volt auxiliary battery to prevent accidental restarting of the vehicle.
 - Auxiliary battery location:
 - Engine compartment (2008 - 2010 Models)
 - Cargo area (2011 Model)

Mechanical Ignition Key System: (Standard on 2011 Model)

1. Confirm the status of the **READY** indicator in the instrument cluster.
2. If the **READY** indicator is illuminated, the vehicle is on and operational. Shut off the vehicle by turning the ignition key off, removing the ignition key and placing it on the dash.
3. Disconnect the 12 Volt auxiliary battery in the cargo area to prevent accidental restarting of the vehicle.

Procedure #2 (Alternate if power button or ignition key is inaccessible)

1. Remove the fuse box cover.
2. Remove the appropriate fuse in the engine compartment fuse box as illustrated on page 22.
 - 30A green IGCT fuse (2008 - 2010 Models)
 - 30A green IG2 Main fuse (2011 Model)If the correct fuse cannot be recognized, pull all fuses in the fuse box.
3. Disconnect the 12 Volt auxiliary battery.
 - Auxiliary battery location:
 - Engine compartment (2008 - 2010 Models)
 - Cargo area (2011 Model)

Recovering/Recycling of NiMH HV Battery Pack

Clean up of the HV battery pack can be accomplished by the vehicle recovery crew without further concern of runoff or spillage. For information regarding recycling of the HV battery pack, contact the nearest Toyota dealer, or:

United States: (800) 331-4331,
Canada: (888) TOYOTA 8 or (888) 869-6828

Emergency Response (Continued)

Spills

The Highlander hybrid contains the same common automotive fluids used in other non-hybrid Toyota vehicles, with the exception of the NiMH electrolyte used in the HV battery pack. The NiMH battery electrolyte is a caustic alkaline (pH 13.5) that is damaging to human tissues. The electrolyte, however, is absorbed in the cell plates and will not normally spill or leak out even if a battery module is cracked. A catastrophic crash that would breach both the metal battery pack case and a metal battery module would be a rare occurrence.

Similar to the use of baking soda to neutralize a lead-acid battery electrolyte spill, a dilute boric acid solution or vinegar can be used to neutralize a NiMH battery electrolyte spill.

NOTE:

Electrolyte leakage from the HV battery pack is unlikely due to its construction and the amount of available electrolyte contained within the NiMH modules. Any spillage would not warrant a declaration as a hazardous material incident. Responders should follow the recommendations as outlined in this emergency response guide.

In an emergency, manufacturer's Material Safety Data Sheets (MSDS) are available by contacting:

United States: CHEMTREC at (800) 424-9300

Canada: CANUTEC at *666 or (613) 996-6666 (collect)

- Handle NiMH electrolyte spills using the following Personal Protective Equipment (PPE):
 - Splash shield or safety goggles. Fold down helmet shields are not acceptable for acid or electrolyte spills.
 - Rubber, latex or nitrile gloves.
 - Apron suitable for alkaline.
 - Rubber boots.
- Neutralize NiMH Electrolyte
 - Use a boric acid solution or vinegar.
 - Boric acid solution - 800 grams boric acid to 20 liters water or 5.5 ounces boric acid to 1 gallon of water.

First Aid

Emergency responders may not be familiar with a NiMH electrolyte exposure when rendering aid to a patient. Exposure to the electrolyte is unlikely except in a catastrophic crash or through improper handling. Utilize the following guidelines in the event of exposure.

WARNING:

The NiMH battery electrolyte is a caustic alkaline (pH 13.5) that is damaging to human tissues. To avoid injury by coming in contact with the electrolyte, wear proper personal protective equipment.

- Wear Personal Protective Equipment (PPE)
 - Splash shield or safety goggles. Fold down helmet shields are not acceptable for acid or electrolyte spills.
 - Rubber, latex or nitrile gloves.
 - Apron suitable for alkaline.
 - Rubber boots.
- Absorption
 - Perform gross decontamination by removing affected clothing and properly disposing of the garments.
 - Rinse the affected areas with water for 20 minutes.
 - Transport patients to the nearest emergency medical care facility.
- Inhalation in Non-Fire Situations
 - No toxic gases are emitted under normal conditions.
- Inhalation in Fire Situations
 - Toxic gases are given off as by-products of combustion. All responders in the Hot Zone should wear the proper PPE for fire fighting including SCBA.
 - Move a patient from the hazardous environment to a safe area and administer oxygen.
 - Transport patients to the nearest emergency medical care facility.
- Ingestion
 - Do not induce vomiting.
 - Allow the patient to drink large quantities of water to dilute the electrolyte (never give water to an unconscious person).

Emergency Response (Continued)

First Aid (Continued)

If vomiting occurs spontaneously, keep the patient's head lowered and forward to reduce the risk of asphyxiation.

Transport patients to the nearest emergency medical care facility.

Submersion

A submerged hybrid vehicle does not have high voltage potential on the metal vehicle body, and is safe to touch.

Access Patients

Responders can access the patient and perform normal extrication procedures. High voltage orange color coded power cables and high voltage components should never be touched, cut, or breached.

Vehicle Recovery

If a hybrid vehicle is fully or partially submerged in water, emergency responders may not be able to determine if the vehicle has been automatically disabled. The Highlander hybrid may be handled by following these recommendations:

1. Remove the vehicle from the water.
2. Drain the water from the vehicle if possible.
3. Follow the immobilizing and disabling procedures on page 19.

Roadside Assistance

Roadside assistance for the Toyota Highlander hybrid may be handled like conventional Toyota vehicles except as noted in the following pages.

Shift Lever

Similar to many Toyota vehicles, the Highlander hybrid uses a gated shift lever as shown in the illustration. However, the Highlander hybrid shift lever includes a brake (B) position, allowing enhanced engine braking when driving down a steep grade.

Towing

The Highlander hybrid is an all-wheel drive vehicle and it must be towed with all four wheels off the ground. Failure to do so may cause serious damage to vehicle components.

- The vehicle may be shifted out of park (P) into neutral (N) by turning the ignition-on, depressing the brake, then moving the gated shift lever to neutral (N).
- If the shift lever cannot be moved out of park (P), a shift lock release button is provided under the cover near the shift lever as shown in the illustration.
- If a tow truck is not available, in an emergency the vehicle may be temporarily towed using a cable or chain secured to the emergency towing eyelet or rear hooks. This should only be attempted on hard, paved roads for short distances at low speeds. The eyelet is located with the tools in the cargo area of the vehicle, refer to the illustration on page 33.

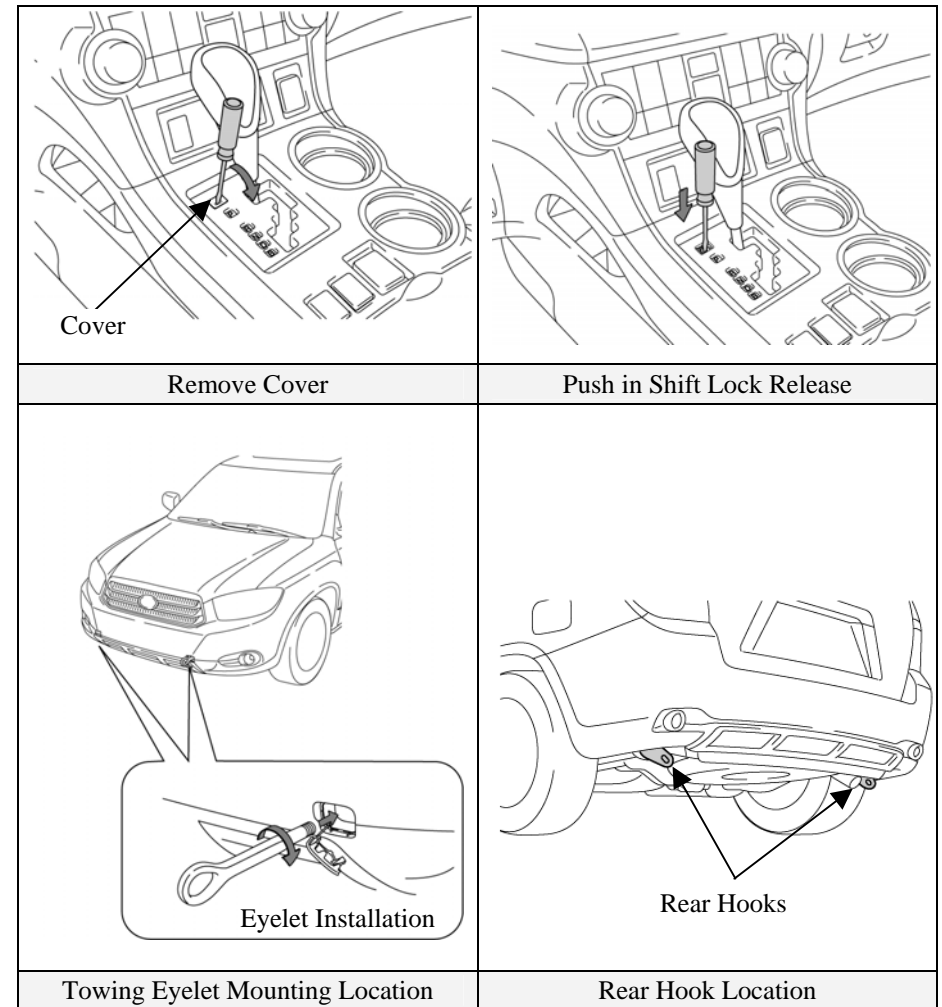

Roadside Assistance (Continued)

Electric Back Door Opener

The Highlander hybrid is equipped with an electric back door opener. In the event of 12 Volt power loss, the back door cannot be opened from the outside of the vehicle.

The electric back door can be opened manually using the release as shown in the illustration.

Electric Fuel Door Opener

The Highlander hybrid is equipped with an electric fuel door opener. In the event of 12 Volt power loss, the fuel door can only be opened using the manual release located inside the cargo area.

⚠ WARNING:

The Highlander hybrid has a fuel vapor containment system that results in the tank pressure being higher than that of a conventional vehicle. If the fuel filler cap is removed after using the manual fuel door release, the vehicle will not automatically reduce the fuel tank pressure. Opening the fuel cap in this state will allow pressurized fuel vapors to escape, and fuel may also be discharged from the filler inlet. For these reasons, be extremely careful and open the fuel cap slowly.

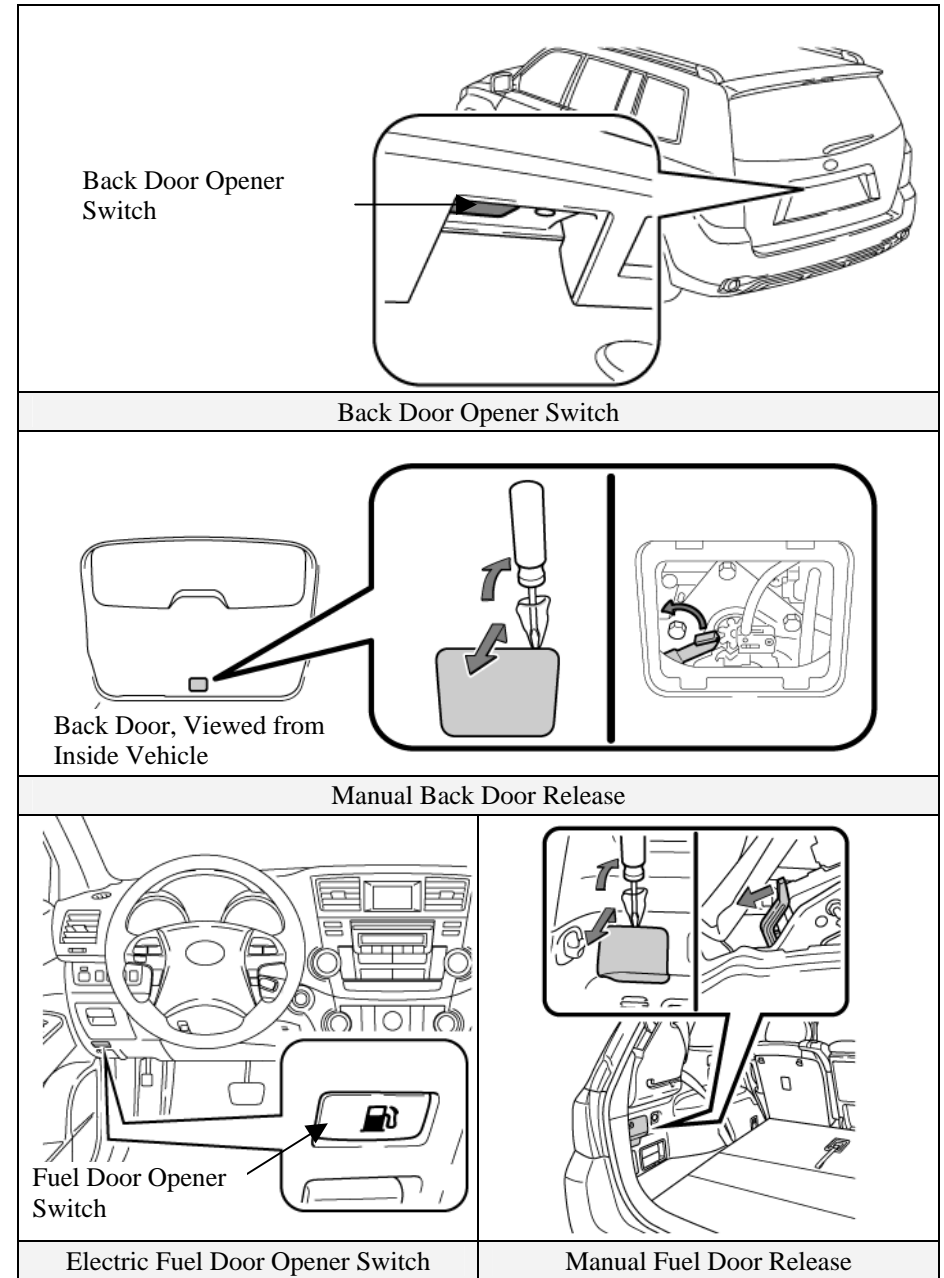

Roadside Assistance (Continued)

Spare Tire

The jack and tools are provided under the carpeted cargo cover and the spare tire is located under the vehicle as illustrated. The spare tire can be lowered using the 5-sided adaptor socket on the tire carrier bolt.

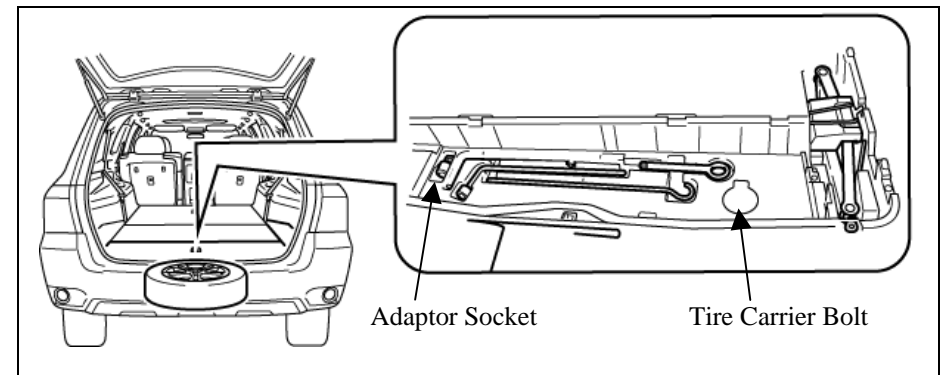

Jack and Tools in the Cargo Area and Spare Tire under the Vehicle

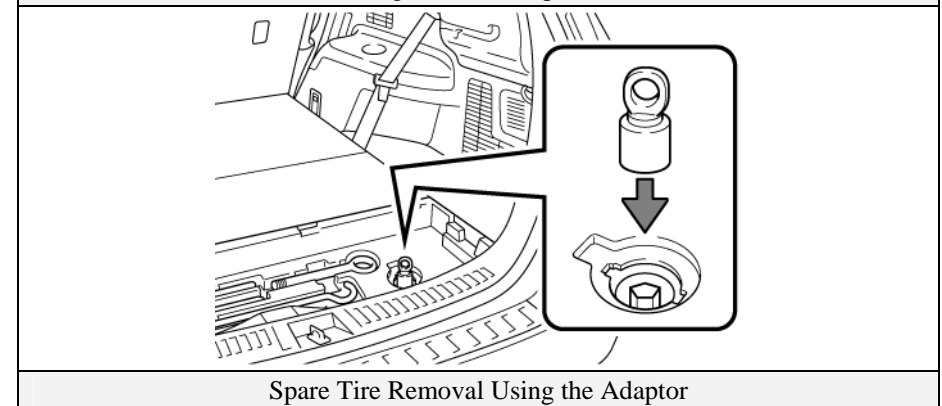

Spare Tire Removal Using the Adaptor

Roadside Assistance (Continued)

Jump Starting

The 12 Volt auxiliary battery may be jump started if the vehicle does not start and the instrument cluster gauges are dim or off after depressing the brake pedal and pushing the power button (with smart key) or turning the ignition key to START (with mechanical ignition key).

2008 - 2010 Models:

The 12 Volt auxiliary battery is located in the engine compartment.

- Open the hood, and remove the cover from the 12 Volt auxiliary battery positive post.
- Connect the positive jumper cable to the positive battery post.
- Connect the negative jumper cable to a solid ground.
- Place the smart key in proximity to the interior of the vehicle, depress the brake pedal, and push the power button.

2011 Model:

The 12 Volt auxiliary battery is located in the cargo area. If the 12 Volt auxiliary battery is discharged, the rear back door cannot be opened. Instead, the vehicle can be jump started by accessing the remote positive 12 Volt auxiliary battery terminal in the engine compartment fuse box.

- Open the hood, and open the positive terminal cover of the fuse box.
- Connect the positive jumper cable to the positive terminal.
- Connect the negative jumper cable to a solid ground.
- Place the smart key in proximity to the interior of the vehicle, depress the brake pedal, and push the power button (with smart key) or turn the ignition key to START (with mechanical ignition key).

NOTE:

If the vehicle does not recognize the smart key after connecting the booster battery to the vehicle, open and close the driver door when the vehicle is shut off.

If the smart key internal battery is dead, touch the Toyota emblem side of the smart key to the power button during the start sequence. See the instructions and illustrations on page 12 for more details.

The high voltage HV battery pack cannot be jump started.

Immobilizer & Optional Anti-Theft Alarm

The Highlander hybrid is equipped with a standard immobilizer system and an optional anti-theft alarm.

- The vehicle can be started only with a registered smart key or mechanical ignition key.
- To disarm the optional anti-theft alarm, unlock the door by using the smart key button, hidden metal cut key, mechanical ignition key, or door handle touch sensor. Turning the ignition-on or starting the vehicle will also disarm the anti-theft alarm.

