

2009 Saturn VUE Two-mode Vehicles

Emergency Response Guide



GM Service Technical College provides First Responder Guides (FRG) and Quick Reference (QR) Sheets free of charge to First Responders. FRGs and QRs can be displayed in a classroom as long as they are represented as GM information and are not modified in any way.

The intent of this guide is to provide information to help you respond to emergency situations involving the Saturn VUE Two-mode vehicles in as safe a manner as possible.

While the majority of the components that make up our Hybrids are common to traditional GM vehicles, there are some differences that may affect how a rescue procedure is performed.

This guide contains a general description of how the Saturn VUE Two-mode vehicle systems operate, gives the location of their Hybrid badging, and offers illustrations of their unique components. The guide also describes methods of disabling the system and presents cut zone information.



Vehicle Identification (cont.)

Special badging is used to identify the Saturn VUE Two-mode Hybrid vehicles. A Hybrid badge is located on the right and left front fenders of the Saturn VUE Two-mode Hybrid vehicles.



One of these emblems is also located on the lower right corner of the vehicle's liftgate.



Vehicle Identification (cont.)

An efficiency gauge with ready lamp is unique to the Saturn VUE Two-mode Hybrid vehicles. On the efficiency gauge there is a position that indicates the vehicle is "OFF".

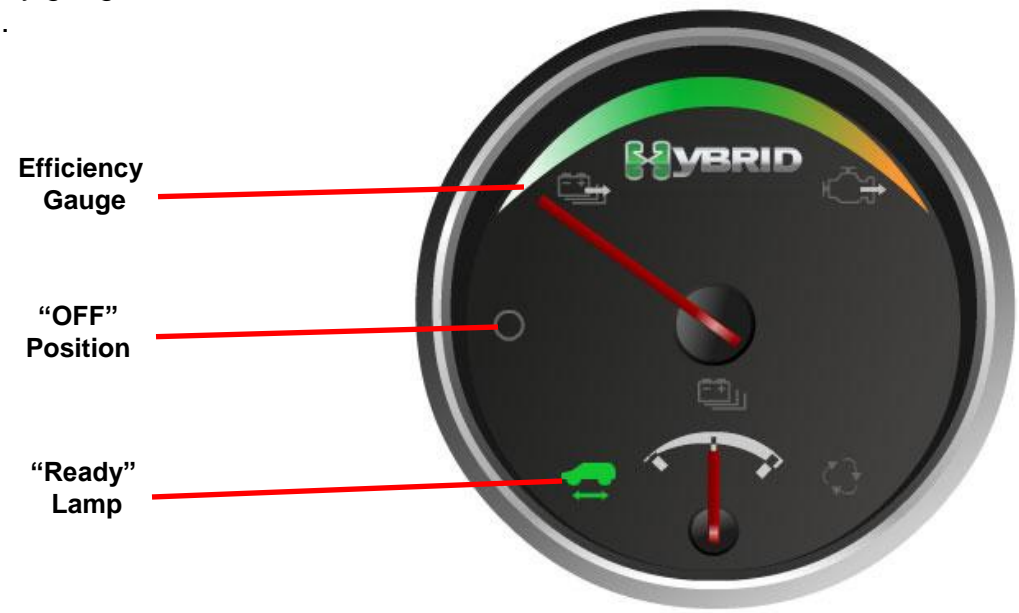

Vehicle Identification (cont.)

When the hood is opened, the Two-mode Hybrid system is identified by a Hybrid badge on the Hybrid sight shield.



Vehicle Identification (cont.)

Located behind the second row seat under the sub-floor is the 300V Hybrid battery.

A “DANGER HIGH VOLTAGE” label is attached to the Hybrid battery case under the felt cover, indicating high voltage.

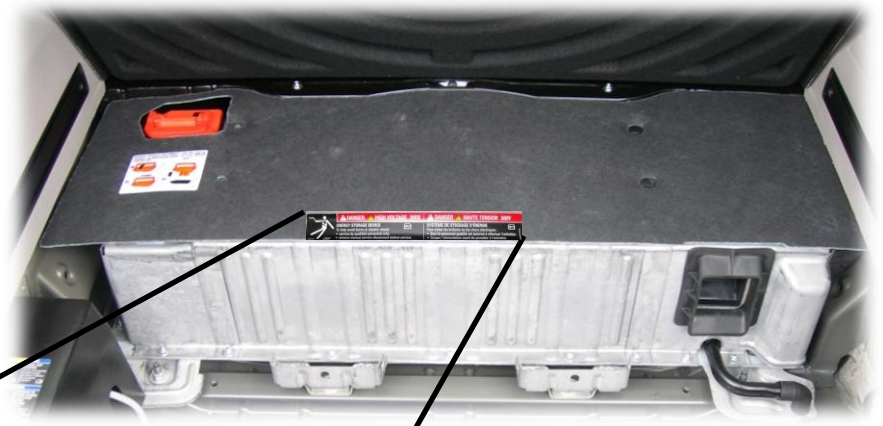

Vehicle Identification

The HP5 option listed on the RPO sheet (located in the glove box), can be used to identify the vehicle as a Two-mode Hybrid.

HP5



System Operation

The Saturn VUE Two-mode vehicles are gasoline-electric Hybrid SUVs that use up to 25 percent less fuel overall and 50% less fuel in the city, than the non-Hybrid Saturn VUE vehicles.

The Hybrid model uses a 300 volt electrical system coupled with a Hybrid transmission and sophisticated technology to achieve its fuel savings.

The vehicle is equipped with a 3.6 liter V6 engine, in addition to the 300 volt and 12 volt electrical systems.



System Operation (cont.)

During braking and deceleration, energy is recovered and stored in the Two-mode Hybrid battery, this is referred to as Regenerative Braking. Another Hybrid feature is the Auto Stop Mode. The system is designed to shut off the engine and operate in electric mode at speeds below 30 miles per hour (at low engine RPM, or low engine torque request), when conditions permit.

During vehicle launch the electric motors within the transmission can propel the vehicle to around 30 miles per hour before the engine is restarted. Other conditions that will cause the engine to restart from Auto Stop Mode include:

- Additional torque is requested for faster acceleration
- Hood is opened
- Hybrid battery charge is low and requires recharging
- Gear selector is moved to Manual
- Climate control system requires engine operation to generate heat



DC/AC Voltage Classifications

The Saturn VUE Two-mode Hybrid vehicles use higher voltage than other Hybrids you may have encountered - they **MUST** be approached with caution.



DC/AC Voltage Classifications

GM has categorized voltage levels as either low, intermediate, or high voltage.

- **Low voltage** – from 0 to 30 volts DC / 0 to 15 volts AC
- **Intermediate voltage** – from 30 volts or greater to 60 volts DC / 15 volts or greater to 30 volts AC
- **High voltage** – any voltage greater than 60 volts DC / 30 volts AC

Classification	Low Voltage	Intermediate Voltage	High Voltage
Voltage Ranges	DC \leq 30v — AC \leq 15v	DC $>$ 30 \leq 60v — AC $>$ 15 \leq 30v RMS	DC $>$ 60v — AC $>$ 30v RMS
Two-mode Hybrid	Vehicle Accessory System	* 42v Electric Power Steering System	120v AC APO 300v DC and AC Hybrid System
* Full Size SUVs and Trucks only			
** 120v AC Accessory Power Outlets (APO)			

Note: Presently there are no industry standards to identify intermediate voltage. GM has chosen the color **BLUE** for this cable color.

Color coding is used to identify the different levels – blue for intermediate voltage cables and orange for high voltage cables.

The Saturn VUE Two-mode Hybrid vehicles fall within the high voltage range. The VUE power steering is a 12 volt system.

Two-mode Hybrids utilize 300V (both AC and DC) for Hybrid System operation. A 120V AC Accessory Power Outlet (APO) is provided at the left, rear corner of the cargo area.

Key Hybrid Components

This illustration shows the location of the key Saturn VUE Two-mode Hybrid vehicle components.

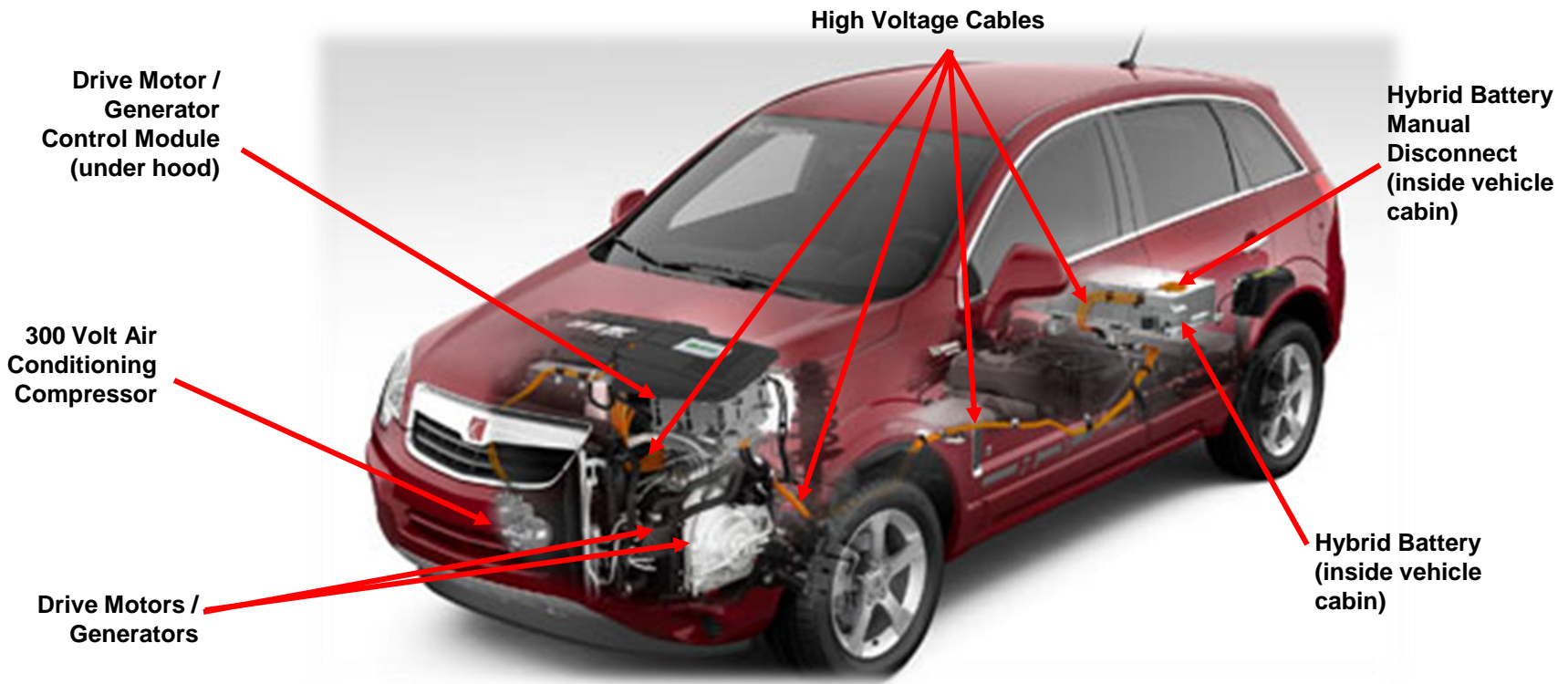

Key Hybrid Components (cont.)

The Saturn VUE Two-mode Hybrid Vehicles use a conventional internal combustion engine coupled with an Electronically Variable Transmission (EVT) that includes two electric motors to efficiently propel the vehicle.

Note: All high voltage cables used in Two-mode Hybrid models are colored orange for easy identification.



Conventional Engine with an Electronically Variable Transmission (EVT)

Key Hybrid Components (cont.)

The Electronically Variable Transmission (EVT) contains two electric motors / generators that are utilized to:

- Propel the vehicle
- Generate / recapture energy
- Start the Internal Combustion Engine (ICE)

Electric
Motors

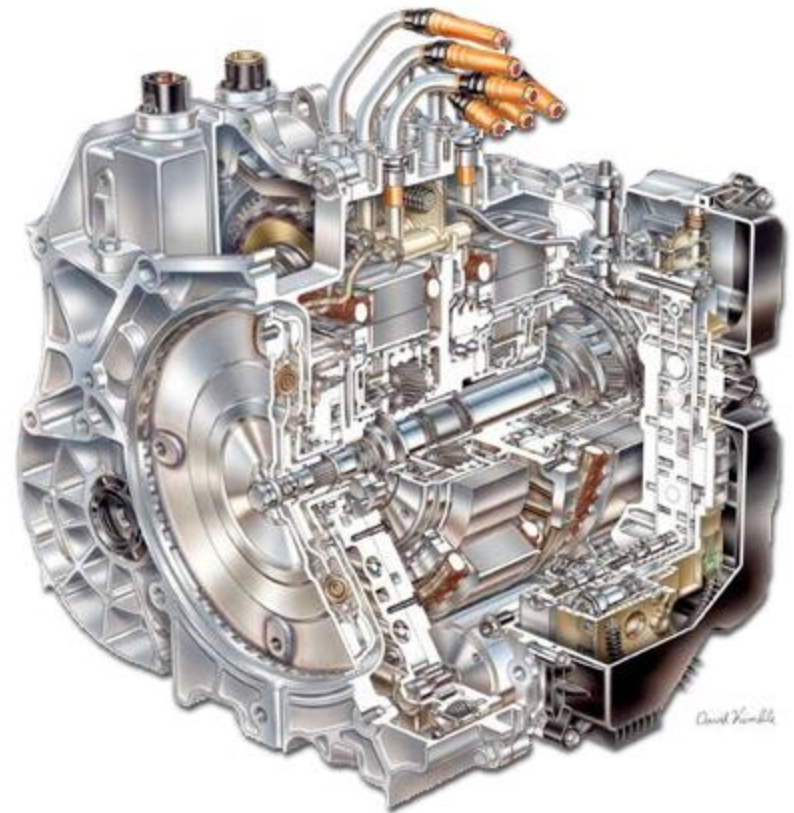

Key Hybrid Components (cont.)

The Drive Motor / Generator Control Module performs the following operations:

- Inverts 300 volts DC to AC for vehicle propulsion
- Inverts 300 volts AC to DC for Hybrid battery recharging
- Provides 300 volts to Air Conditioning Compressor
- Converts 300 volts DC to 12 volts DC for conventional 12 volt accessory operation

Note: Orange wiring is used to indicate high voltage.



Key Hybrid Components (cont.)

A Nickel Metal Hydride (NiMH) 300 volt Hybrid battery is enclosed in a metal case located behind the second row seat, under the sub-floor. This 300V Hybrid battery supplies and stores energy for the vehicle.

**300V Hybrid Battery
Manual Disconnect**

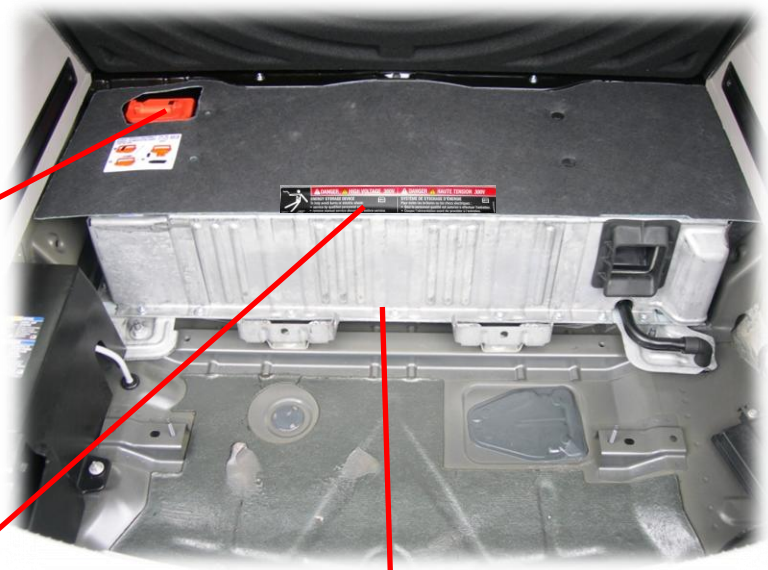

300V Hybrid Battery



Key Hybrid Components (cont.)

A hood ajar switch is part of the hood latch and prevents Auto Stop Mode from occurring if the hood of the vehicle is open.

If the hood is opened while the vehicle is in Auto Stop Mode, the engine will restart.

Note: The hood ajar switch will NOT prevent current flow through the 300 volt electrical system.

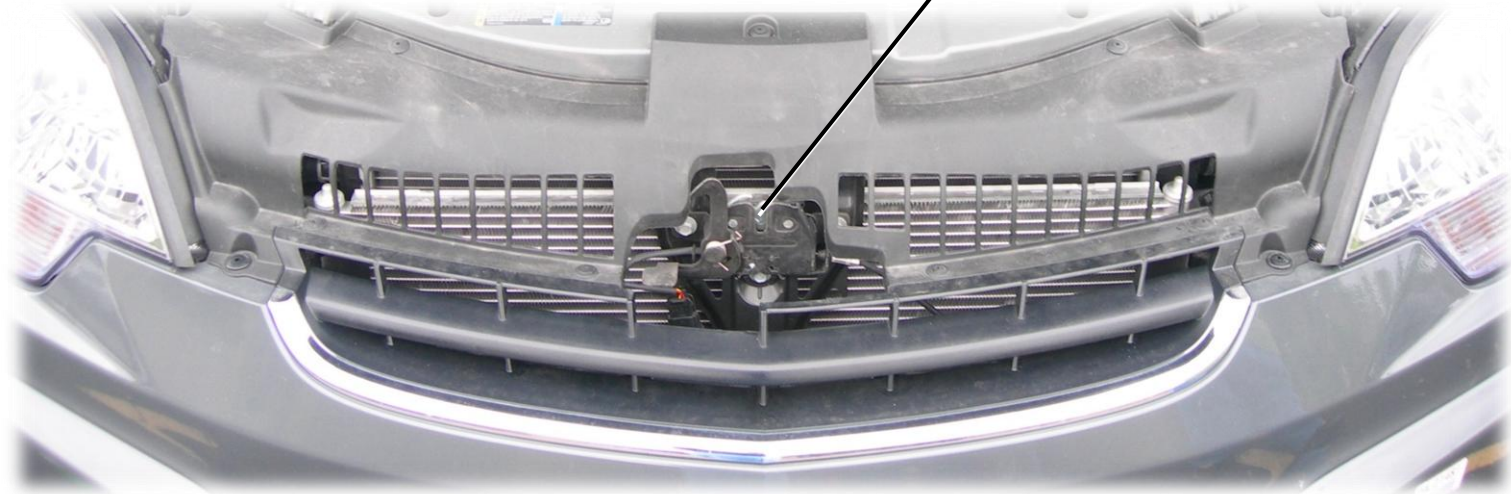
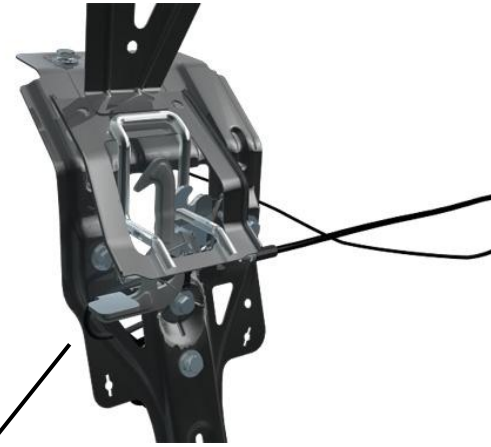

Approaching a Two-mode Vehicle in Auto Stop Mode:

If you approach a Two-mode Hybrid vehicle operating in Auto Stop Mode, it may appear the vehicle is turned OFF, or the engine has stalled. Auto Stop Mode occurs under many conditions, including when the vehicle is in Park, Neutral or Drive and may last for several minutes. While in Auto Stop Mode the engine may restart without warning. Any of the following conditions will cause the engine to restart if the vehicle is in Auto Stop Mode:

- The hood is opened
- The shift lever is moved to or is in the Manual position (Manual 2)
- The 300V Battery charge becomes too low
- Engine temperature drops too low

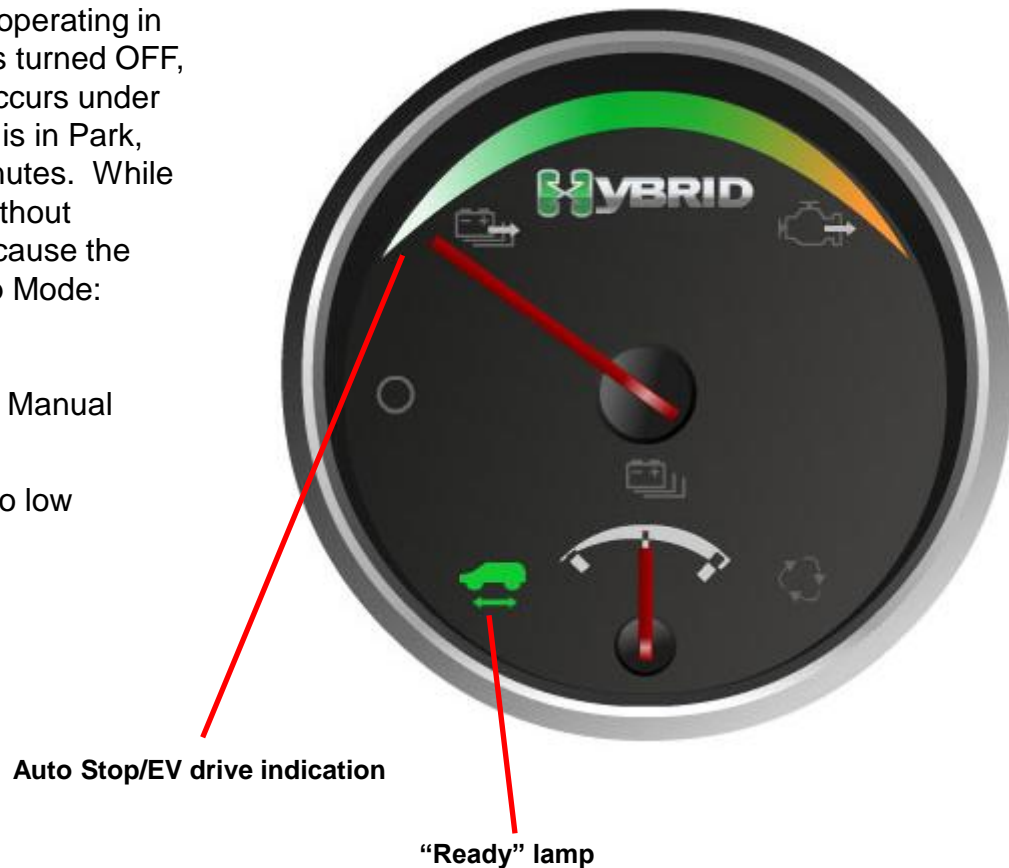

Approaching a Two-mode vehicle in Electric Vehicle (EV) Mode:

While operating in Auto Stop Mode, the Two-Mode Hybrid is also capable of propelling the vehicle electrically. Referred to as Electric Vehicle (EV) Mode, this mode allows the vehicle to be propelled at speeds up to 30 mph, (40 Kp/h) while the engine is not running. Without depression of the accelerator pedal, just enough energy is provided by the electric motors to allow the vehicle to creep slowly when in gear. This operation is similar to a Non-Hybrid vehicle that has an idling engine. Depressing the accelerator pedal allows the vehicle to propel, and depending on the amount of pedal depression, could also result in the starting of the engine.

Perform the disabling 12V power procedure to ensure that all vehicle propulsion modes have been disabled.



How to identify if vehicle is “OFF”

1. Key should be turned to the “OFF” position and removed.
2. Efficiency gauge should be at the “OFF” position.
3. “Ready” lamp should not be illuminated.

“OFF”
Position

“Ready”
Indicator
(not illuminated)



Air Bag Deployment

The contactors inside the Hybrid battery are designed to open if one or more air bags deploy. This causes an interruption of the 300 volt electrical system and discontinues current flow in the high voltage cables.

This vehicle may have dual-stage airbags and the appearance of deployed airbags does not ensure that all parts of the airbags have deployed.

Therefore, disabling 12 volt power is essential to ensure personal safety even if the airbags in the vehicle appear to have been deployed. After disabling 12V power, wait at least 10 seconds to allow any un-deployed air bag reserve energy to dissipate.



First Responder Labels

GM has implemented the labels shown here to help First Responders safely disable the vehicle in an emergency situation.

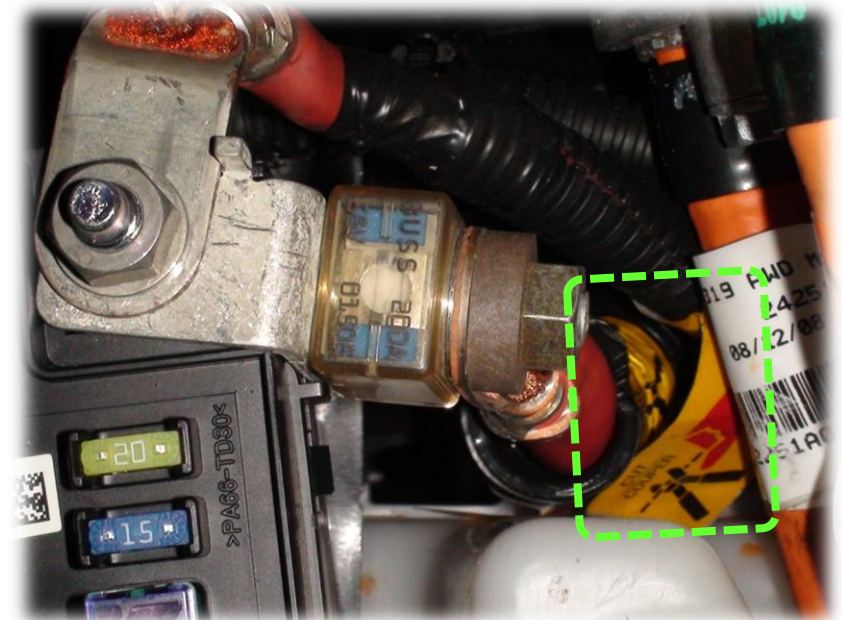

To disable 12V power you must:

1. Turn the ignition key to the OFF position.
- And -
2. Remove the 12 volt (+) positive battery cable from the battery post. Ensure the terminal cannot contact the battery post (**located in the left rear of the vehicle**).

Note: After disabling 12V power, wait at least 10 seconds to allow any un-deployed air bag reserve energy to dissipate.

Important:

If the ignition key is **NOT** accessible, please refer to the next page for the steps to follow in disabling 12V power in this situation.

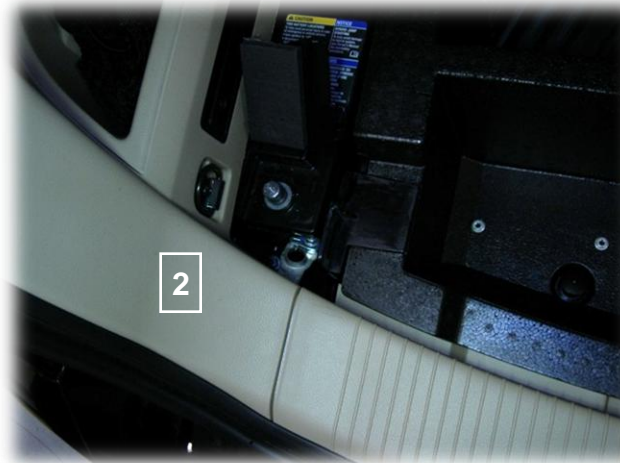

To disable 12V power when the ignition key is NOT accessible, you must:

Locate the 12 volt cables at the underhood fuse box (front center of the engine compartment) – to cut and separate all three cables.

1. Cut both 12V cables at the dotted lines shown.

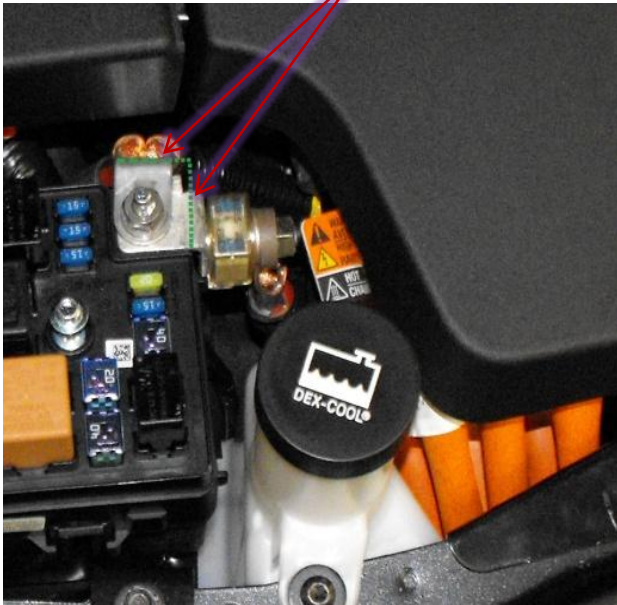

2. Pull up each cable and cut each cable below the crimped terminal area.

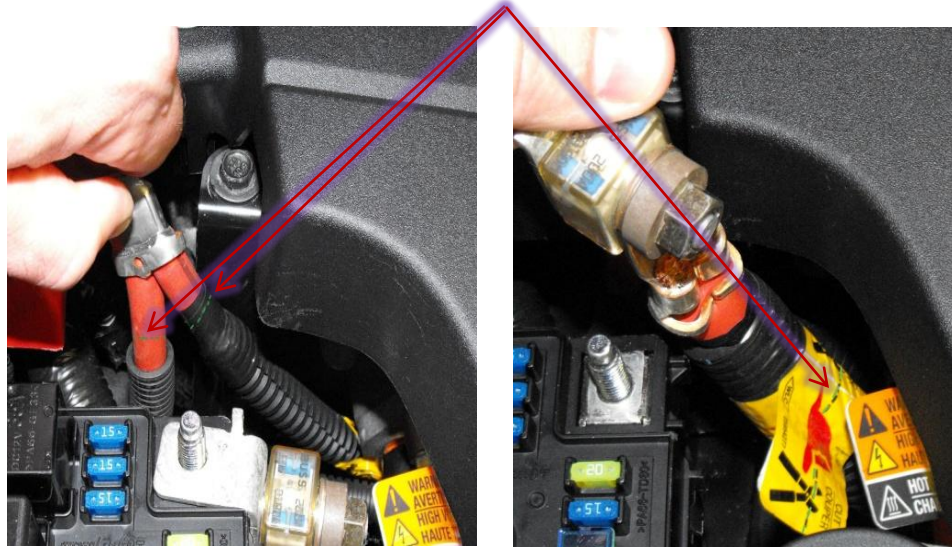

3. After cutting the cables, separate all three cables so they do not touch.

Note: After disabling 12V power, wait at least 10 seconds to allow any un-deployed air bag reserve energy to dissipate.

High Voltage Manual Disconnect

If accessible, you can further minimize the potential for 300V current flow by removing the manual disconnect lever from the 300 volt Hybrid battery (located at the left front of the 300V battery). The hybrid battery is located behind the rear seats under the load floor.

1. Lift handle



2. Slide towards center of battery



3. Pull up to disengage

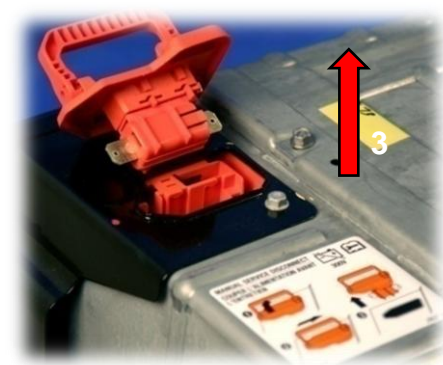

DANGER: The manual disconnect lever is designed to facilitate servicing of the vehicle. The energy potential within the 300V battery cannot be disabled. Even with the disconnect removed, assume the high voltage cables and components contain high voltage. If the 300 volt battery is exposed, it should only be handled by a properly trained technician - Otherwise, serious injury or death may occur.



High Voltage Cables - DO NOT CUT ZONES

Performing the “Disabling 12 Volt Power” procedure on the previous pages, will eliminate current flow through the 12 volt system and should also disable the high voltage electrical system, external to the 300V battery.

DANGER: Do NOT cut the orange high voltage 300 volt cables. Cutting these cables can result in serious injury or death. No matter what disable method you have performed, always assume the high voltage cables and components contain high voltage.

Vehicle DO NOT CUT ZONES

Do NOT cut the:

- Area near the passenger side frame rail. High voltage 300 volt wiring is routed near the frame rail on the passenger side of the vehicle.
- Roof rails between the windshield and 'D' pillars (rear pillars). Saturn VUE Two-mode Hybrid vehicles are equipped with side impact air bags.
- Two-mode Hybrid battery. The Two-mode Hybrid battery has 300 volt electrical potential at all times.

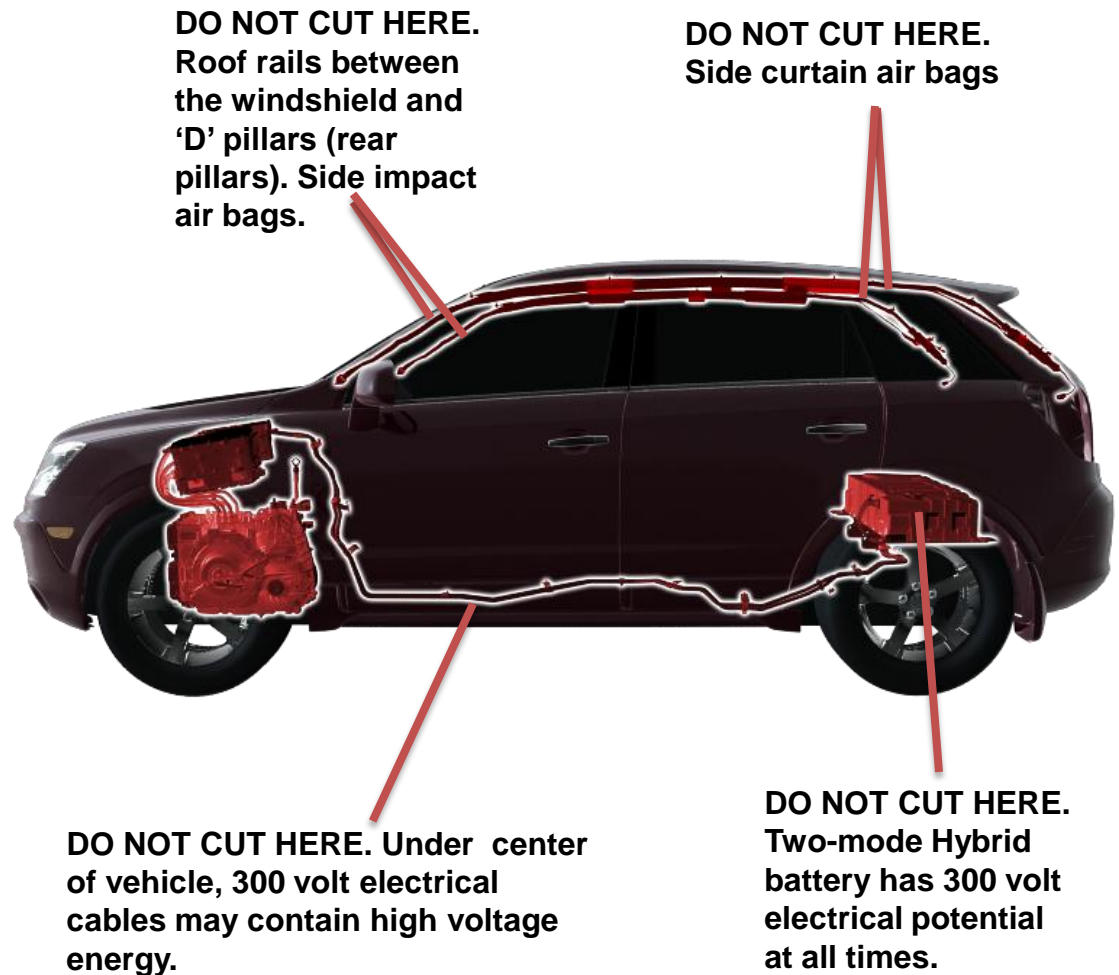

WARNING: Do NOT cut into the vehicle until the 12V electrical system has been deactivated. Cutting into the vehicle prior to disconnecting and isolating the 12V electrical energy sources may cause air bag deployment resulting in serious injury.



Neutralizing a Battery Leak

The Nickel Metal Hydride (NiMH) battery contains Potassium Hydroxide and if a leak is detected, a mixture of boric acid solution or vinegar, or a Class D fire extinguisher should be used to neutralize the spill.

Refer to your MSDS sheet for more information.

POTASSIUM HYDROXIDE		0357 October 2000	
CAS No: 1310-58-3 RTECS No: TT2100000 UN No: 1813 EC No: 019-002-00-6		Caustic potash Potassium hydrate Potassium lye KOH Molecular mass: 56.1	
TYPES OF HAZARD/ EXPOSURE	ACUTE HAZARDS/SYMPTOMS	PREVENTION	FIRST AID/FIRE FIGHTING
FIRE	Not combustible. Contact with moisture or water may generate sufficient heat to ignite combustible materials.		In case of fire in the surroundings, all extinguishing agents allowed.
EXPLOSION			
EXPOSURE		AVOID ALL CONTACT!	IN ALL CASES CONSULT A DOCTOR!
Inhalation	Corrosive. Burning sensation. Sore throat. Cough. Laboured breathing. Shortness of breath. Symptoms may be delayed (see Notes).	Local exhaust or breathing protection.	Fresh air, rest. Half-upright position. Artificial respiration if indicated. Refer for medical attention.
skin	Corrosive. Redness. Pain. Blisters. Serious skin burns.	Protective gloves. Protective clothing.	Remove contaminated clothes. Rinse skin with plenty of water or shower. Refer for medical attention.
Eyes	Corrosive. Redness. Pain. Blurred vision. Severe deep burns.	Face shield, or eye protection in combination with breathing protection if powder.	First rinse with plenty of water for several minutes (remove contact lenses if easily possible), then take to a doctor.
Ingestion	Corrosive. Abdominal pain. Burning sensation. Shock or collapse.	Do not eat, drink, or smoke during work.	Rinse mouth. Do NOT induce vomiting. Give plenty of water to drink. Refer for medical attention.
SPILLAGE DISPOSAL		PACKAGING & LABELLING	
Sweep spilled substance into suitable containers. Wash away remainder with plenty of water. (Extra personal protection: complete protective clothing including self-contained breathing apparatus).		C Symbol R: 22-35 S: (1/2)-105-35/37-39-45 UN Hazard Class: 8 UN Pack Group: II	
EMERGENCY RESPONSE		STORAGE	
Transport Emergency Card: TEC (R)-123 NFPA Code: H 3; F 0; R 1		Separated from strong acids, metals, food and feedstuffs. Dry. Well closed. Store in an area having corrosion resistant concrete floor.	
  			
Prepared in the context of cooperation between the International Programme on Chemical Safety and the European Commission. © IPCS 2000 SEE IMPORTANT INFORMATION ON THE BACK.			

Conclusion

We are serious about making your job as safe as possible.

As you have seen, certain differences exist between the Saturn VUE Two-mode Hybrid vehicles and conventional vehicles. These differences require forethought when approaching an emergency situation concerning these Two-mode Hybrid vehicles.

We are confident the information contained in this guide will prove useful as you prepare to assist those involved in an emergency event.



For information regarding modification of GM's First Responder Information for other uses, contact GM's Licensing Manager at:

GM Licensing Program Hdqtrs
5775 Enterprise Ct
Warren, MI 48092
Attn: Licensing Coordinator