



Guidelines for Rescue Services  
Trucks  
2005/2006 Edition



Mercedes-Benz

# Guidelines for Rescue Services Trucks

2005/2006 Edition

### **Ordering workshop information**

All printed workshop information from GSP/TI can be ordered as follows:

#### **Within Germany:**

From our GSP/TI shop on the internet at the following link:

<http://gsp-ti-shop.daimlerchrysler.com>

or alternatively

E-mail: [service.information@daimlerchrysler.com](mailto:service.information@daimlerchrysler.com)

Fax: +49-711-17-83451

#### **Outside Germany:**

Please get in touch with the contact person responsible for your market.

### **Questions and suggestions**

If you have any questions or suggestions concerning this product, please write to us at:

Fax: +49-711-17-8 34 34

or

DaimlerChrysler AG

GSP/TIO

HPC R822

D-70546 Stuttgart

© 2005 Copyright DaimlerChrysler AG

This document, including all its parts, is protected by copyright. Any further processing or use requires the previous written consent of DaimlerChrysler AG. This applies in particular to reproduction, distribution, alteration, translation, microfilming and storage and/or processing in electronic systems, including databases and online services.

Title Image No. Envelope: N00.01-2383-00

<b>Preface</b>	5
----------------	---

## Overview

<b>Model overview and notes</b>	6
<b>Differences between passenger cars and trucks</b>	12
<b>Disconnecting the vehicle battery</b>	14
<b>GGVS vehicles (hazardous goods vehicles)</b>	18

## Truck accident characteristics

<b>Truck damage profiles after a rear-end collision</b>	20
<b>The most frequently occurring accidents</b>	21
<b>Casualty injury patterns</b>	23
<b>The golden hour of shock</b>	26
<b>Tactical procedure</b>	27

## Proper casualty rescue

Initiation	30
Initial access	31
Securing the area	33
Stopping the engine	34
Reducing the rescue height	37
Securing the cab	44
Glass handling	45
Securing the door	49
Removing the door	50
Pushing away the front end	51
Safety systems	55
Airbag	55
Seat belt/emergency tensioning retractor	60
Steering wheel adjustment	61
Seat adjustment	63

## Annex

Literature and sources	65
Index	66

### Dear Reader,

One of DaimlerChrysler's top priorities has traditionally been to guarantee the highest possible standards of safety.

And this is especially true for vehicle safety.

Our comprehensive safety concept also extends to providing rescue crews with specific information about our vehicles and their safety systems.

The top priority of the rescue crew is to save lives. The rescue team must be able to gain access to the casualties as quickly as possible without exposing them or themselves to additional danger.

In order to do this, the rescue services must be properly trained. In addition, knowledge of vehicle-specific accessibility options, of the function and operation of the safety systems, and of the special features of trucks is absolutely essential.

We must emphasize that these guidelines cannot claim to be exhaustive and on no account should they, nor are they intended to, act as a substitute for sound specialist training and the relevant specialized literature.

These guidelines are intended to assist the rescue service in the tactical planning of its rescue operations. As every accident is different, the sequence of actions described here may not be suitable for the actual circumstances of the case at hand.

DaimlerChrysler AG

Parts Engineering and Technical Information (GSP/TI)

## Model overview and notes

### Dimensions of a cab

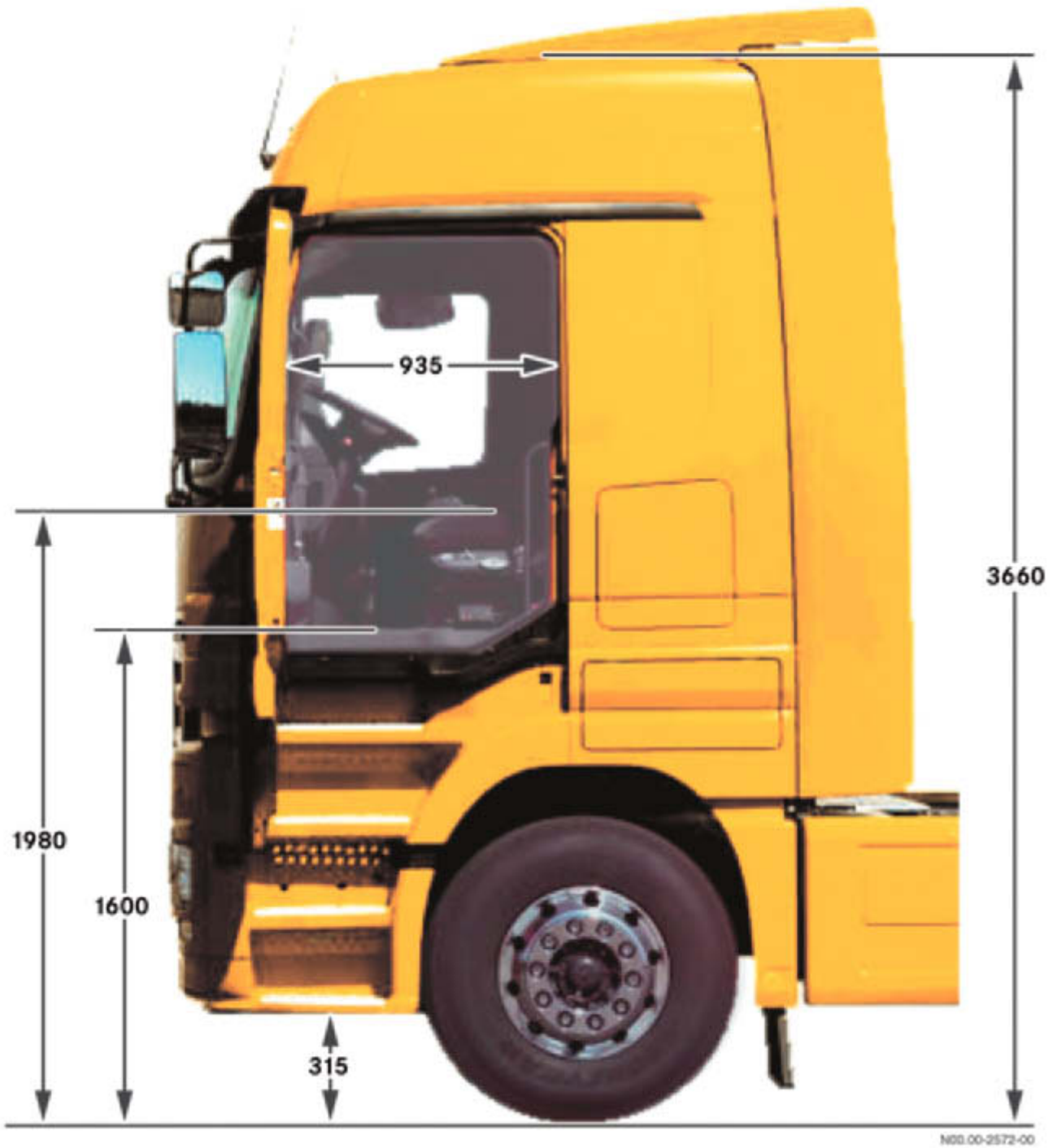

*Example dimensions, here on a Megaspacer cab for a vehicle with 295/80 R22.5 tires (dimensions in mm)*

### Special features of trucks

The basic design of all trucks is similar. The basic framework is formed by a so-called ladder-type frame made of high-strength steel profile longitudinal members (must never be cut with hydraulic rescue gear), which are joined to crossmembers. The engine and transmission are installed in the front of this frame and the axles are bolted on. Above the engine is the sprung cab, which is usually mounted on the frame with a 4-point mounting. The cab mounting is designed to allow the cab to be tipped forward in order to service the engine.

The cab is a self-supporting all-steel structure (exception: Econic is an aluminum structure with plastic paneling) and forms a kind of safety cell.

For the truck to be registered in Sweden it must satisfy the so-called "Swedish test". A special equipment variant available for this is, however, very rare in the German market.

Another option for modern trucks are driver airbags in combination with seat belts and emergency tensioning retractors. The 3-point seat belt is integrated in the driver's suspension seat. The suspension seat is fitted with an air suspension system, which enables ergonomic and largely non-tiring sitting. The steering wheel can be adjusted to suit the driver's position, i.e. its height and angle can be adjusted.

Depending on their usage, there are many differences between the vehicles. Long-haul vehicles, usually semitrailer tractors, have bunks behind the seats, for example.

The full air suspension already installed in many vehicles can be utilized to reduce the rescue height to allow proper casualty rescue.



## Model overview and notes

### Examples

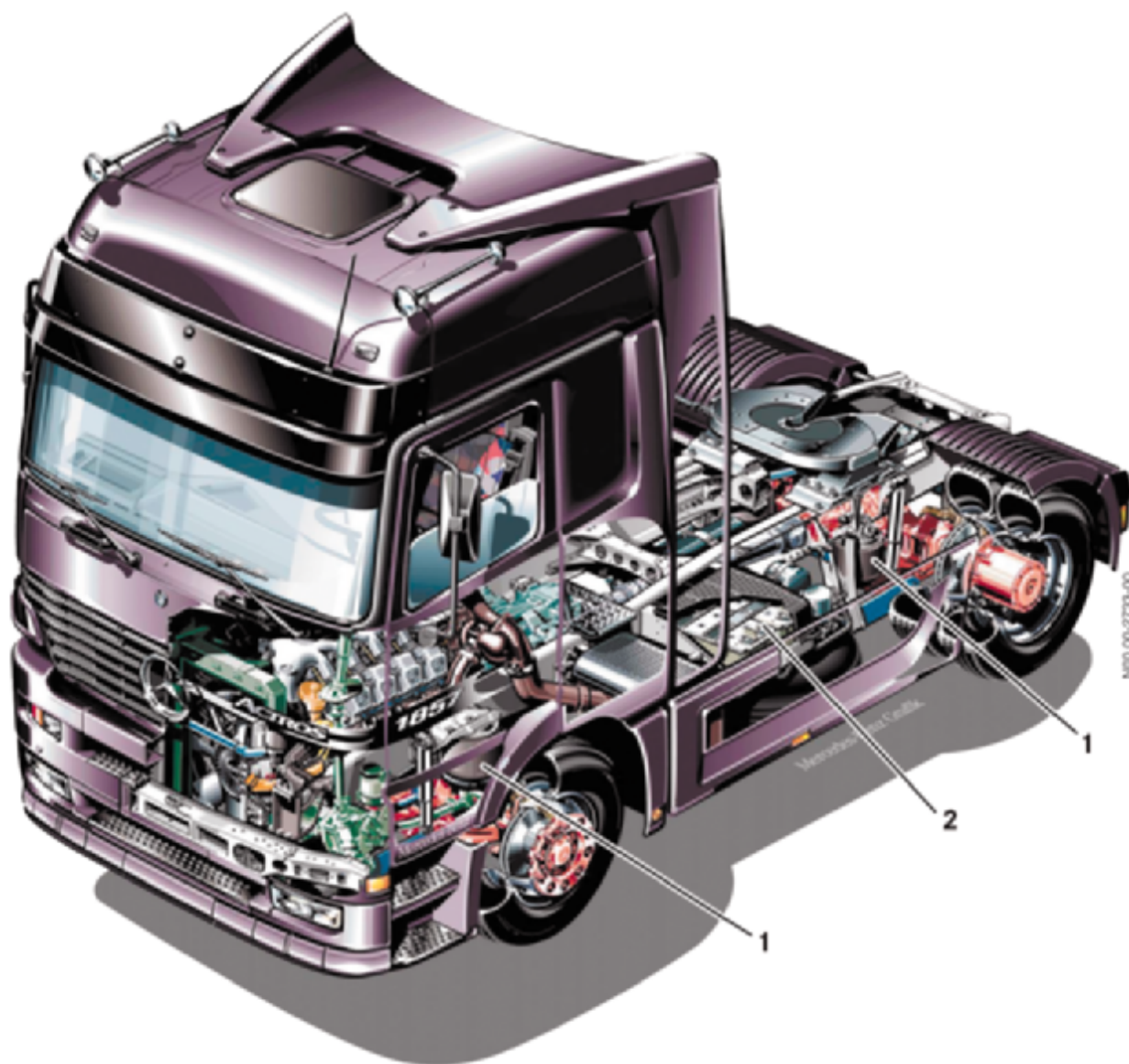

#### **Mercedes-Benz Actros 1857 LS (Actros)**

- 1 Frame air suspension
- 2 Battery box

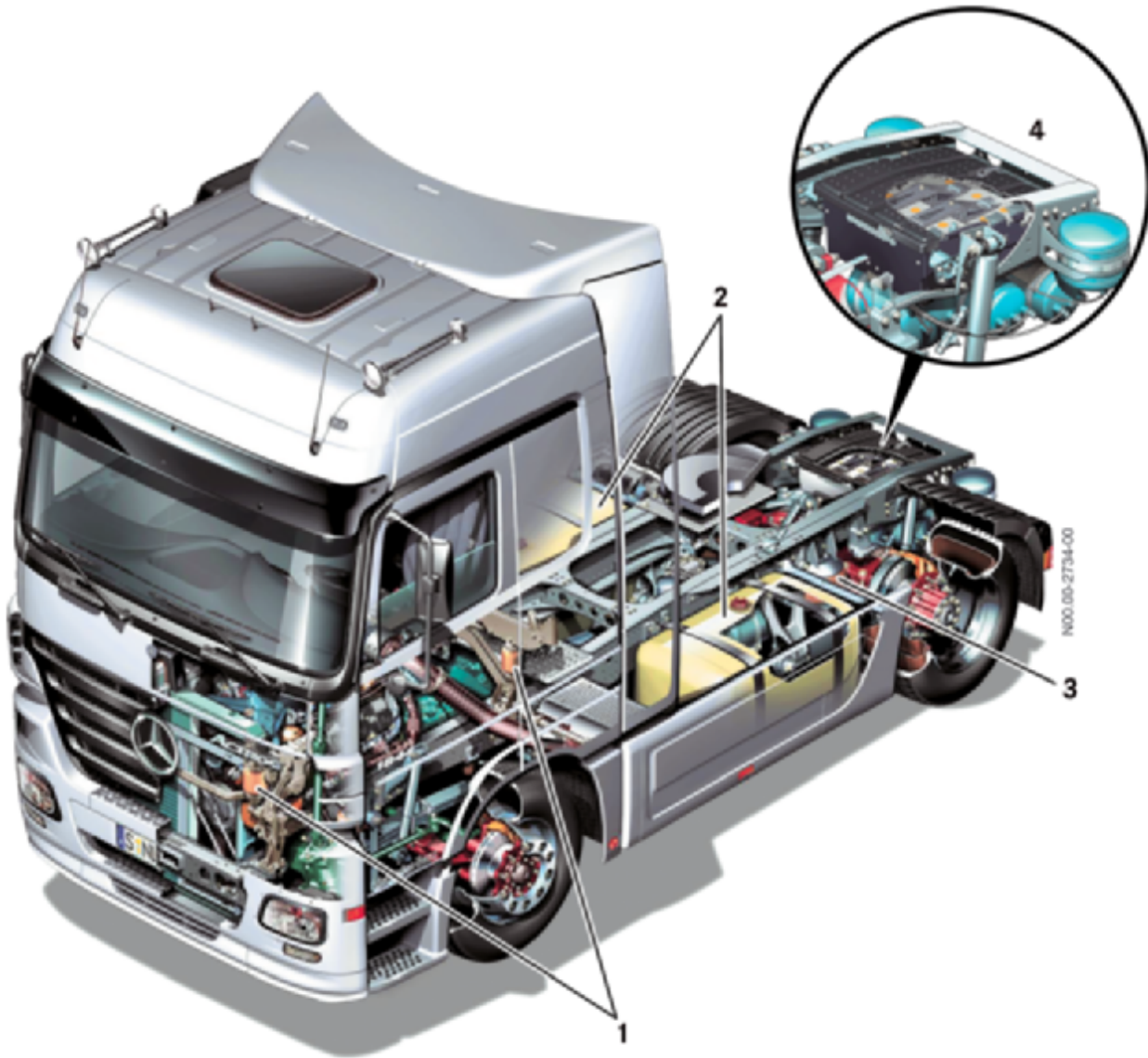

**Mercedes-Benz Actros 1844 LS (Actros 2)**

- 1 Air springs, cab mounting
- 2 Fuel tank
- 3 Frame air suspension
- 4 Integral rear end

## Model overview and notes

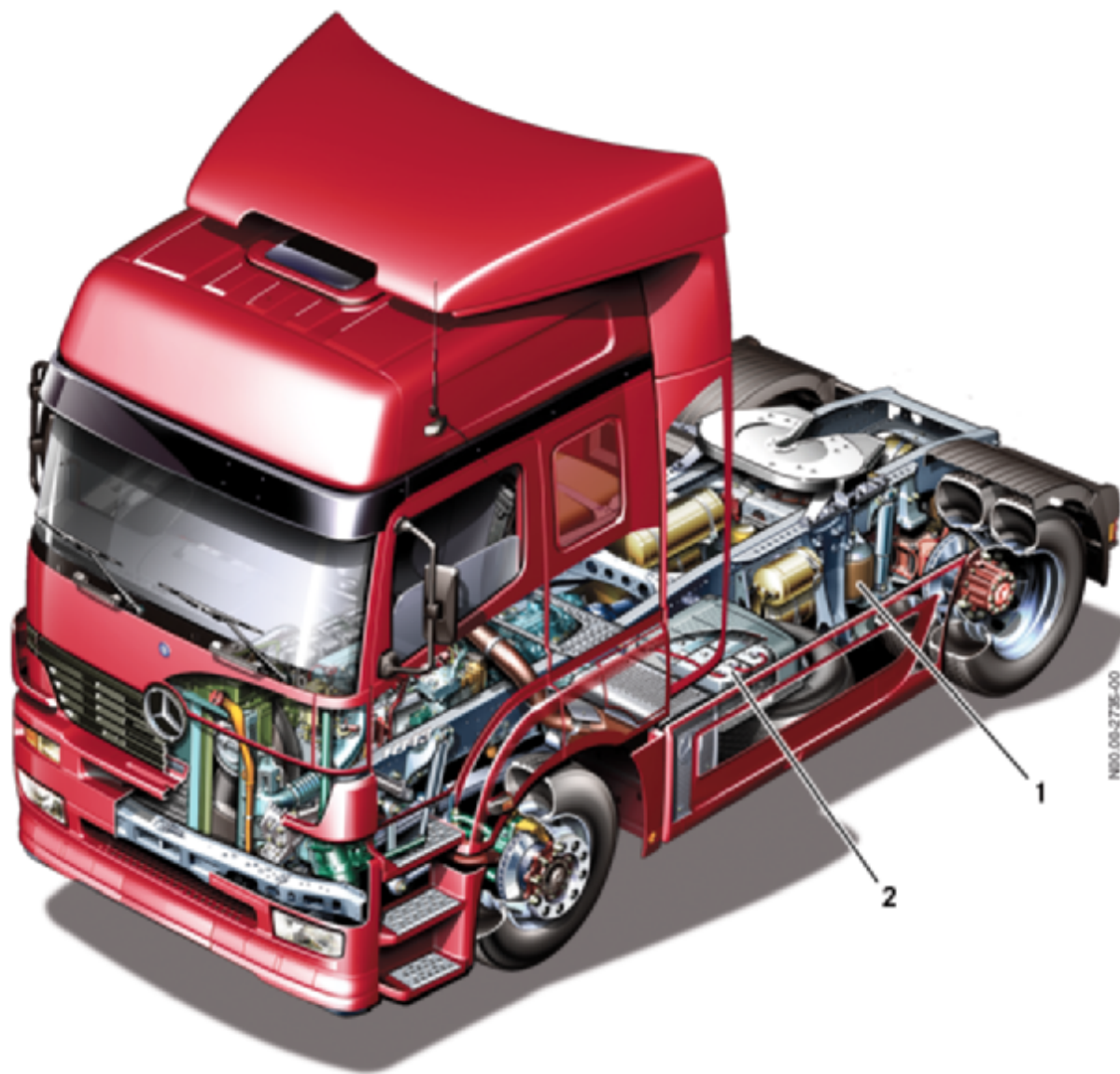

### **Mercedes-Benz Axor 1**

- 1 *Frame air suspension*
- 2 *Battery box*



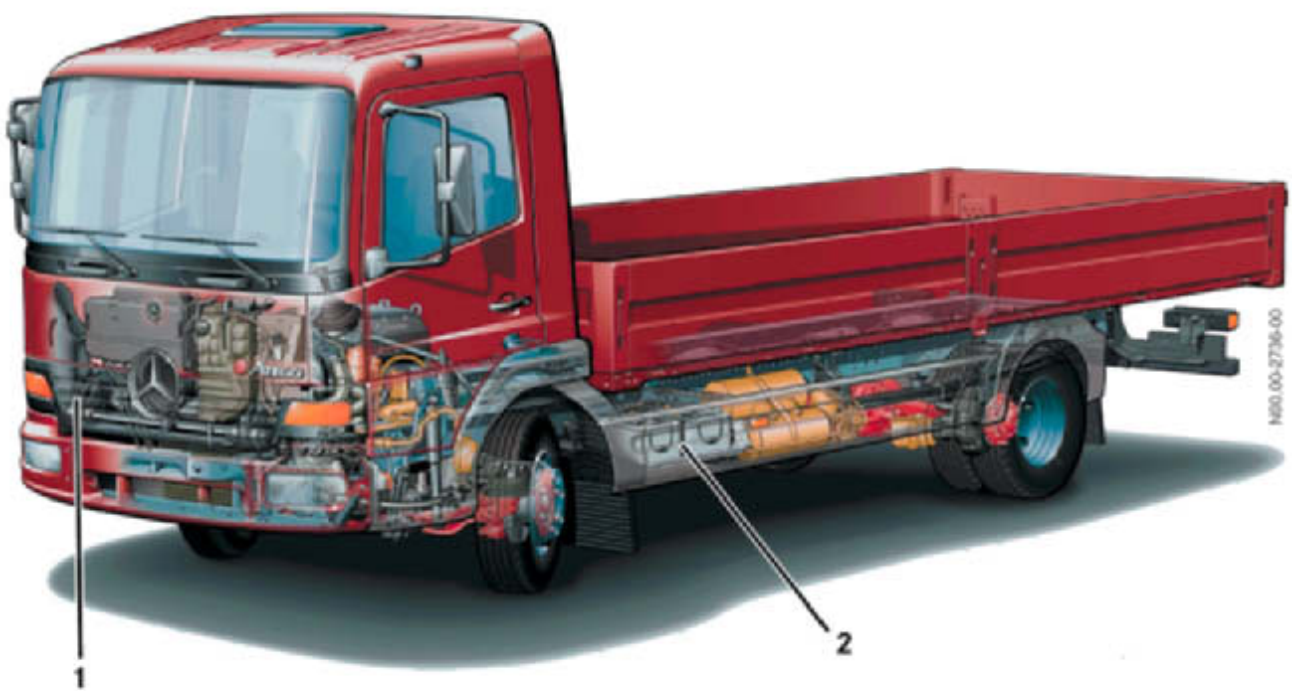

**Mercedes-Benz Atego 1**

- 1 Air intake
- 2 Batteries

## Differences between passenger cars and trucks



N00.00-2737-00

The rescue of occupants from crashed passenger cars is now common practice for rescue crews. It is often practiced on scrap cars.

In the case of commercial vehicles, however, and trucks in particular, the situation is different. Due to their long service life and high salvage value thereafter, it is difficult for fire crews to practice the rescue of injured casualties from trucks using current vehicle models.

Proper casualty rescue from trucks is generally much more complicated in comparison with passenger car accidents. The stronger construction and much larger dimensions of these vehicles make the rescue of trapped casualties more difficult and more complicated. Driver cabs can reach heights of up to 3.70 m. The seat sitting surface is not uncommonly almost

2 meters above the road surface. In cab-over-engine chassis in particular, the driver is exposed to serious risk in an accident due to the lack of a crumple zone and the severe forces that may occur in a truck collision.

## Differences between passenger cars and trucks

Due to the high impact energy, it is quite common for the driver to be trapped by the dash support and the steering unit in an accident.

The risks for the occupants vary according to the height of the collision object:

- If the collision zone is level with the frame or lower, the consequences for a properly belted occupant are relatively slight.



*Driver strapped in, front passenger not strapped in.  
Collision with dummy flatbed at 30 km/h*

- If the point of impact is higher, and the impact energy is high, the driver is likely to be trapped and suffer serious injuries to the lower extremities (legs).



*Deformed footwell  
(Rescue exercise at Ludwigshafen on 15.09.2001)*

## Disconnecting the vehicle battery

 <b>Risk of injury</b>	<b>Measures</b>
<p>Battery acid is caustic. When handling batteries or battery acid, comply with all safety regulations and precautions (flip down your visor and wear safety glasses).</p>	<p>Never bend over batteries when working on them (risk of caustic burns and explosion!)</p> <p>Battery acid must not be allowed to come into contact with the skin, eyes, clothing or vehicle paintwork.</p> <p>Rinse off acid splashes immediately with clean water.</p> <p>Never touch the battery first. Always touch the bodywork from outside the vehicle beforehand in order to dissipate any electrostatic charge that may be present.</p>

 <b>Risk of explosion!</b>	<b>Measures</b>
<p>A highly explosive gas mixture is produced when batteries are being charged. Therefore there is a risk of explosion if improperly handled!</p>	<p>Do not smoke near the batteries.</p> <p>Avoid creating sparks and open flames.</p> <p>Do not place any metal objects on the battery. Otherwise you could cause a short circuit and the highly explosive gas mixture from the battery could ignite.</p> <p>Do not rub the battery with rags or cloths. An electrostatic charge may cause the battery to explode on contact or when a spark crosses over.</p>

Before disconnecting the battery, you should attempt to operate electrical consumers such as the power windows, seat adjustment etc. in a way that would facilitate the rescue. A check of this kind can simplify the further course of action considerably.

 <b>Risk of injury</b>	<b>Measures</b>
<p>The suspension seat moves downward when the EMERGENCY OFF switch is actuated.</p> <p>On some vehicles, disconnecting the battery can cause the pneumatically adjustable seats to move down.</p> <p>Any uncontrolled movement of an injured casualty represents a further risk of injury.</p>	<p>This measure should only be performed in consultation with the emergency physician.</p>

## Location of battery

The batteries are located on the left-hand side of the chassis frame, or in semitrailer tractors depending on version, at the end of the frame between the longitudinal frame members (integral rear end). Battery boxes on semitrailer tractors with integral rear end are accessible only after uncoupling the semitrailer.



*Battery box (1) on driver side (implement carrier)*

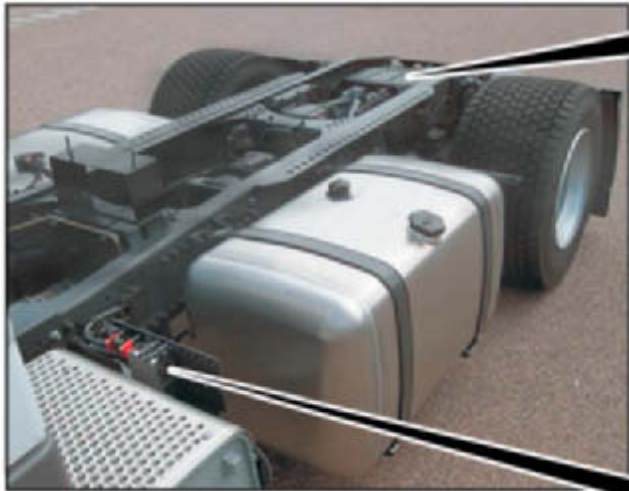

## **Integral rear end**

- 1 Battery box
- 2 Distribution box on frame behind end muffler



## Disconnecting the vehicle battery

### Disconnecting the battery

- Remove key from steering wheel lock
- Switch off all electrical consumers
- Open and remove battery cover
- Disconnect negative terminal
- Disconnect positive terminal
- Hold the positive and negative cables together in order to discharge any potential that may be stored in the capacitors
- Secure the cables, e.g. with cable ties, to prevent the systems from being switched back on or the cables from being reconnected



**Battery box (1) on driver side (implement carrier)**

- 1 Positive terminal
- 2 Negative terminal

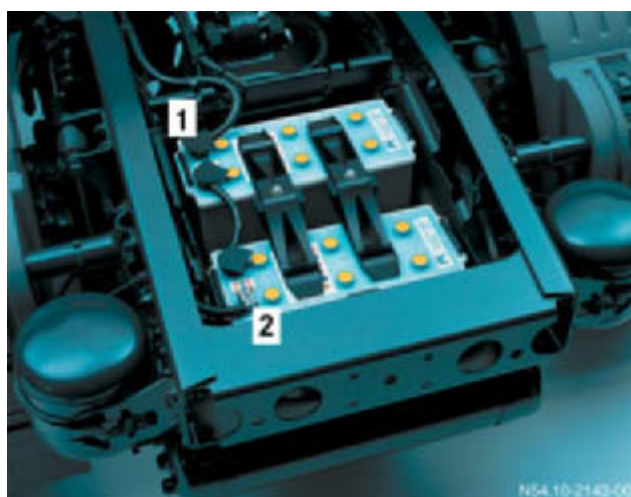

**Integral rear end**

- 1 Positive terminal
- 2 Negative terminal

## Safety information for handling car batteries



Keep children away from acid and batteries!



**Caution:**

A (highly explosive) gas mixture is produced when batteries are being charged, so there may be a risk of explosion if improperly handled. For this reason, please note:



No fire, sparks, open flames or smoking. Avoid making sparks when handling cables and electrical equipment, and sparks from electrostatic discharge. Avoid short circuits.



**Caution! Risk of caustic burns:**

Battery acid is highly caustic, so protective gloves and eye protection should be worn. Batteries must not be tilted otherwise acid may escape from the degassing holes.



Wear eye protection!



**First aid:**

Acid splashed into the eye should be immediately flushed out with clean water for several minutes. Then seek medical attention without delay. Acid splashed onto the skin or clothing must be neutralized immediately with an acid neutralizer or soapy water.



**Warning:**

Do not expose batteries to direct sunlight without protection. Flat batteries may freeze, so they should be stored where they are protected from frost.



**Disposal:**

Used batteries should be handed in at a collection point for proper disposal!



Never dispose of batteries with household refuse.

Source: [www.Varta-Automotive.com](http://www.Varta-Automotive.com)

## GGVS vehicles (hazardous goods vehicles)

### Peculiarities of GGVS vehicles (hazardous goods vehicles)

Vehicles used for transporting hazardous goods are equipped with two manual EMERGENCY OFF switches:

- In the cockpit on the instrument panel
- Behind the cab on the passenger side

The switches are used to interrupt the voltage supply in an emergency and to prevent short circuits with sparks which may ignite a fire or an explosion.

The following components remain supplied with electricity when the EMERGENCY OFF switch is actuated.

- Tachograph
- Anti-theft alarm system

When the EMERGENCY OFF switch is actuated, the engine is shut off automatically.

### Cockpit

The EMERGENCY OFF switch interrupts the voltage supply to the main consumers.

The engine is switched off automatically.

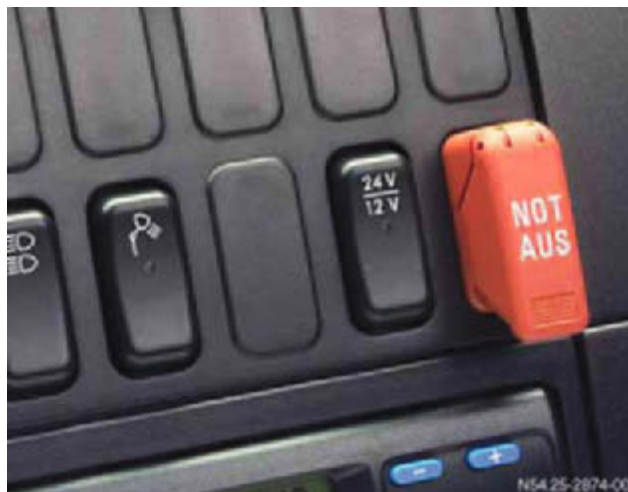

*Location of EMERGENCY OFF switch in cockpit*

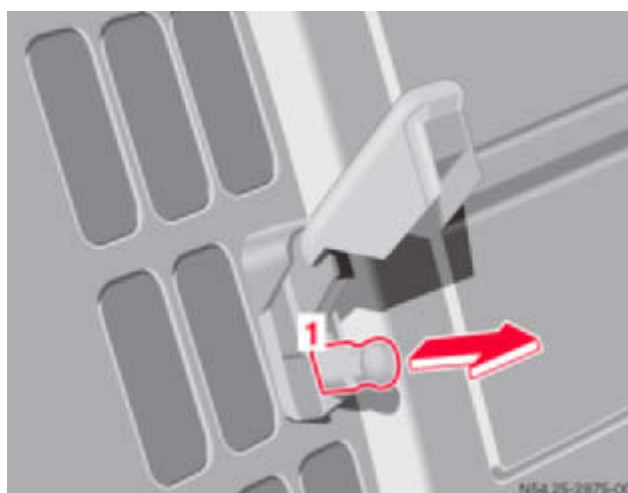

*Open the cover and pull the switch pin (1)*

## Passenger side behind the cab



*Possible location of EMERGENCY OFF switch on the right behind the cab*

The EMERGENCY OFF switch interrupts the voltage supply to the main consumers.

The engine is switched off automatically.

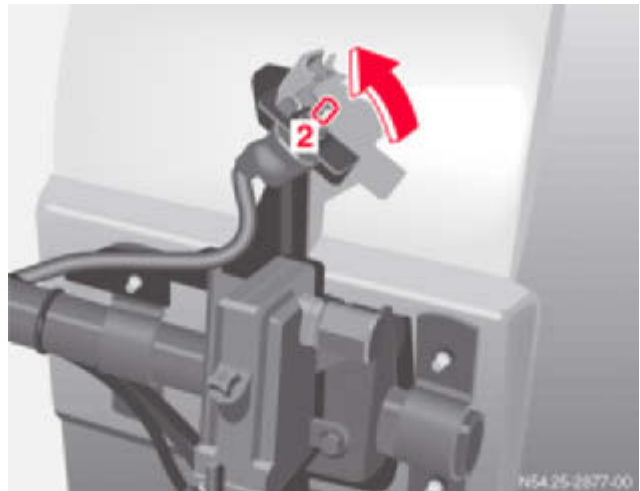

*Open the cover and swing the switch (2) upwards*

 <b>Risk of injury</b>	<b>Measures</b>
<p>The suspension seat moves downward when the EMERGENCY OFF switch is actuated.</p> <p>Any uncontrolled movement of an injured casualty represents a further risk of injury.</p>	<p>This measure should only be performed in consultation with the emergency physician.</p>

## Truck damage profiles after a rear-end collision





## Scene of accident and road type

### Truck > 10 t: distribution of road type (N = 17850)

50% random sample by Federal Statistical Office, accident year 2002/2003

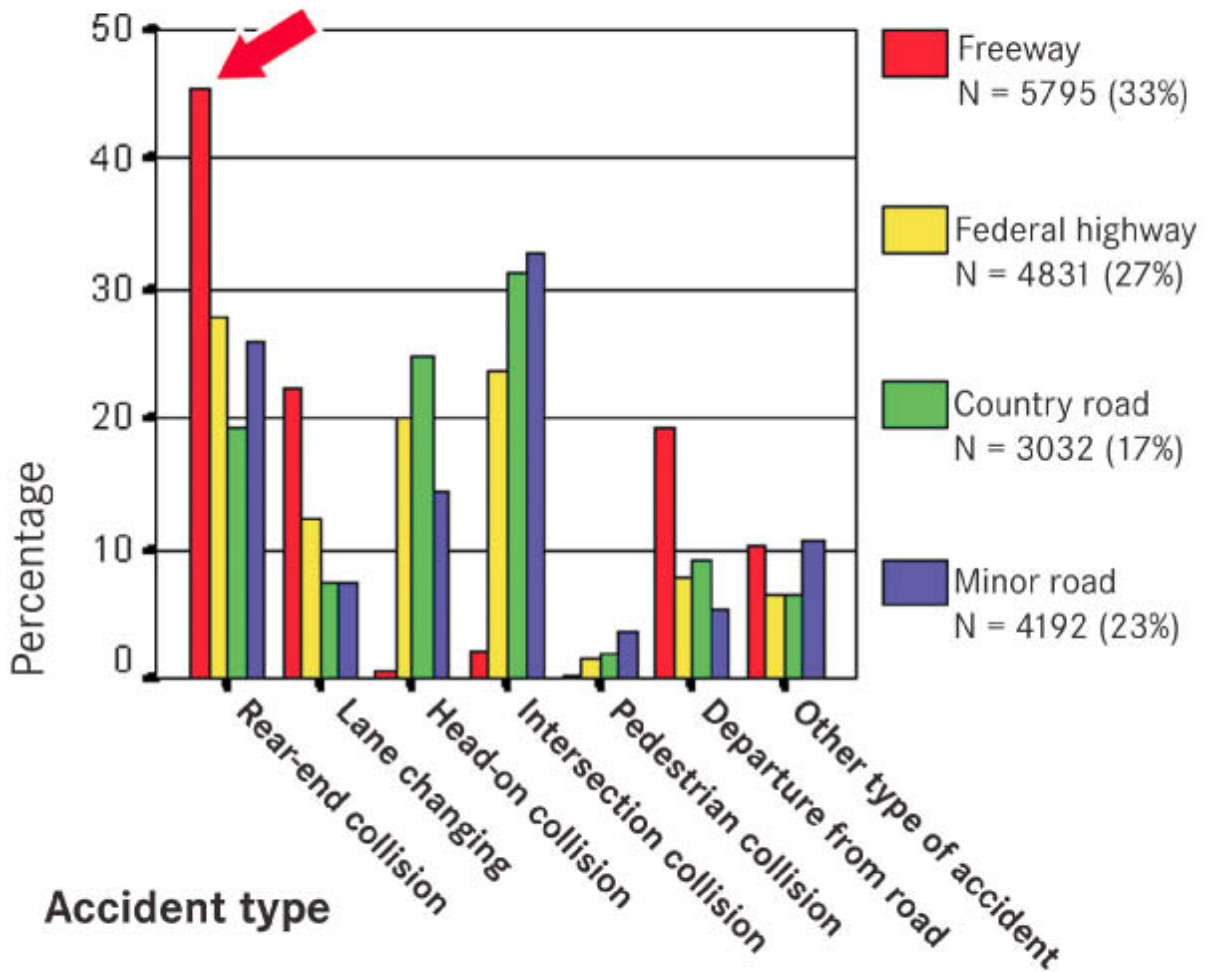

- Accidents on freeways and federal highways are most common for heavy commercial vehicles.
- Of these, rear-end collisions are the most significant.
- However, all road types are relevant for heavy commercial vehicles.

## The most frequently occurring accidents

Type and severity of accident

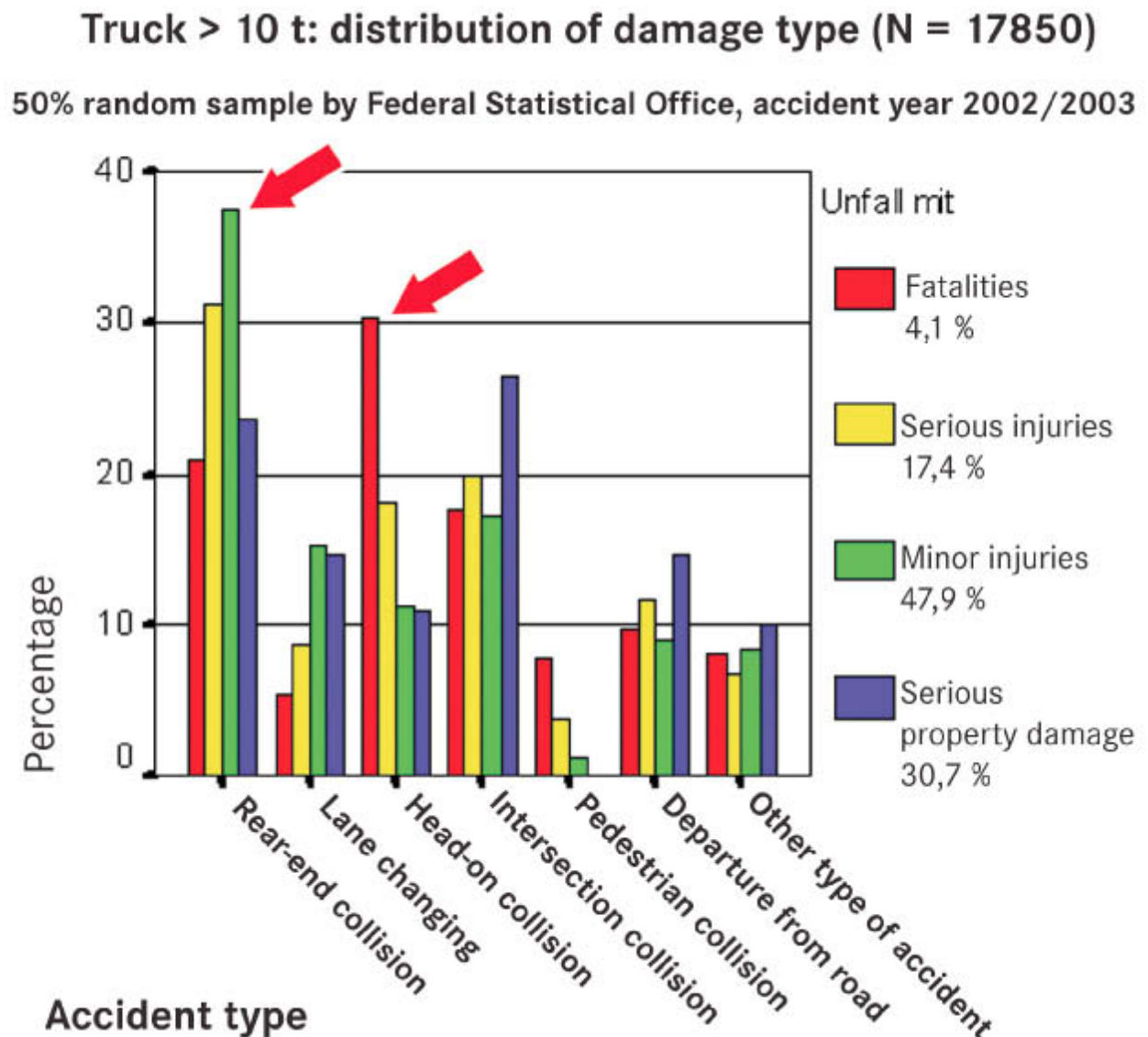

N30.00-2745-00

- One third of all fatal accidents involving heavy commercial vehicles are head-on collisions with oncoming traffic. In these, the occupants of passenger cars are at particular risk. These also include accidents of the type "car rear-ends truck".
- Rear-end collisions form the greatest proportion of both accidents with serious injuries and those with minor injuries.

## Casualty injury patterns

These figures were recorded at the Berufsgenossenschaftliche Unfallklinik (Clinic for Trauma Surgery) in Ludwigshafen/Rhein between 1999 and 2002. A total of 78 traffic accidents was studied involving injured truck occupants who had to be hospitalized at the clinic between 01.01.1996 and 31.12.2001 due to the effects of their injuries.

The study examined the frequency of injury to a particular area of the body on the casualties with no evaluation of the severity of injury in all accidents as well as in each individual type of accident. The increased frequency of cranial injuries (48.7% of the total) was conspicuous, as was that of injuries to the upper (42.3%) and lower extremities (65.4%). Almost as expected, injuries to the lower extremities were disproportionately high in collision-type accidents.

### Total accidents

A total of 78 traffic accidents with a total of 78 patients was studied.

n = number of individual injuries

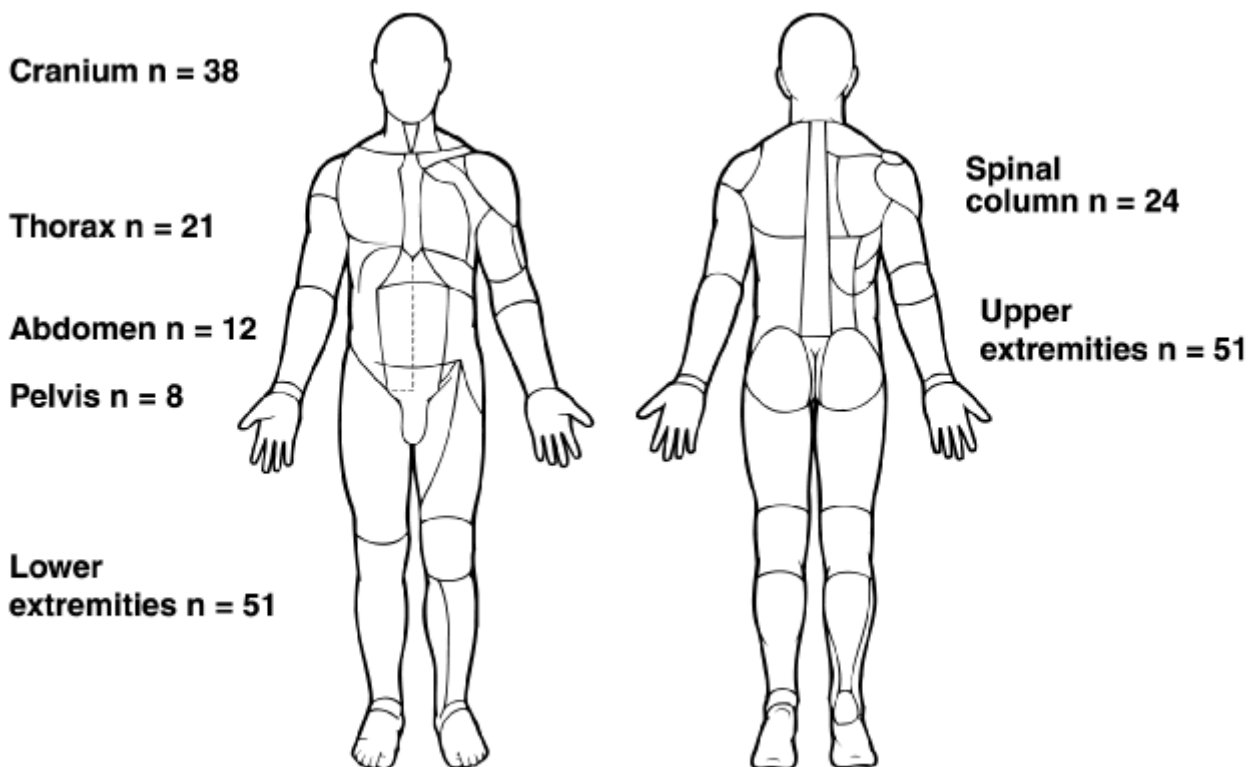

N00.00-2746-00



## Casualty injury patterns

### Collisions (53 accidents)

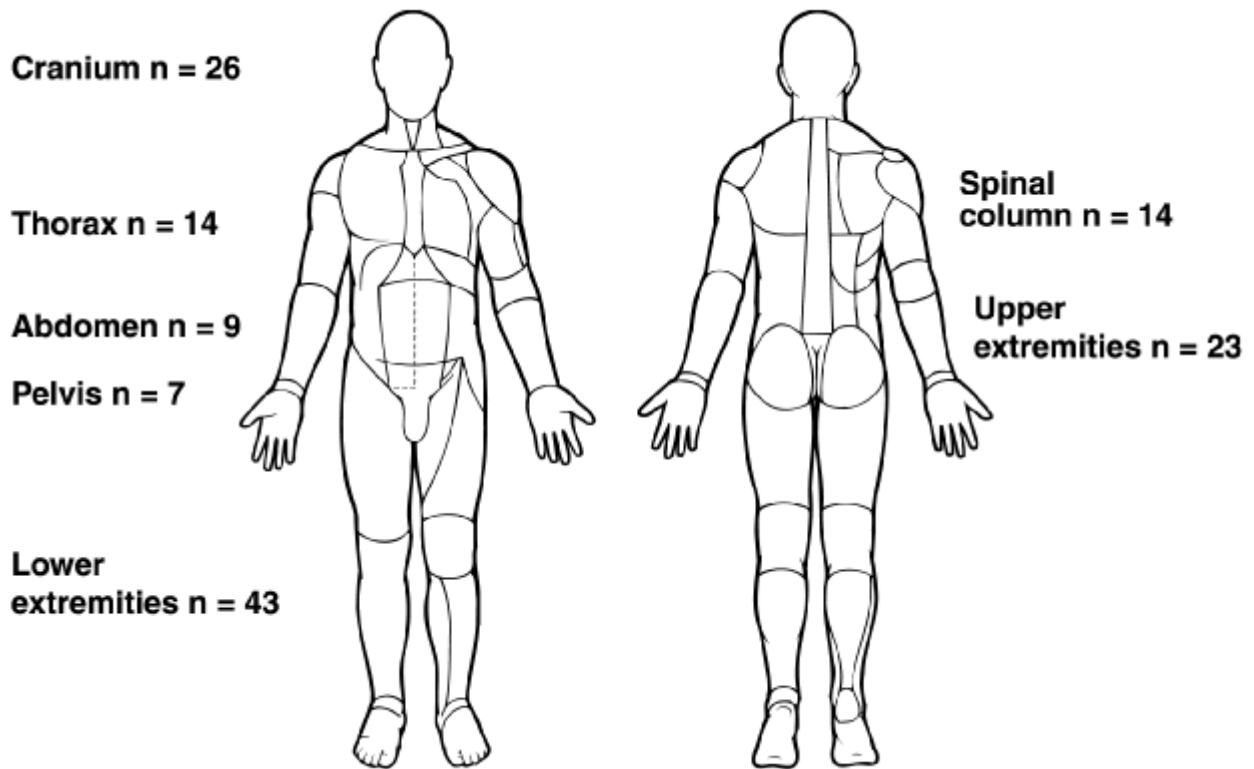

N00.00-2747-00

### Overturning accidents (19 fatalities)

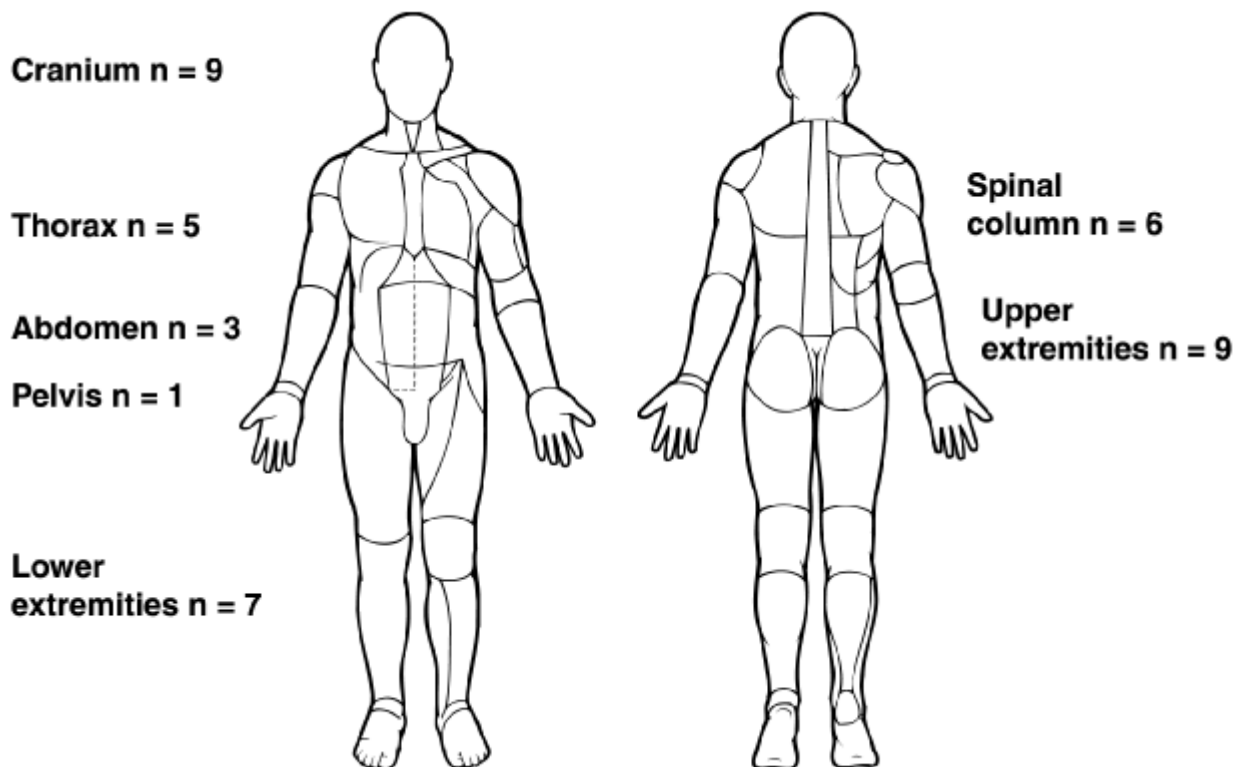

N00.00-2748-00

## Complex accidents

Collision in combination with the vehicle overturning (6 accidents)

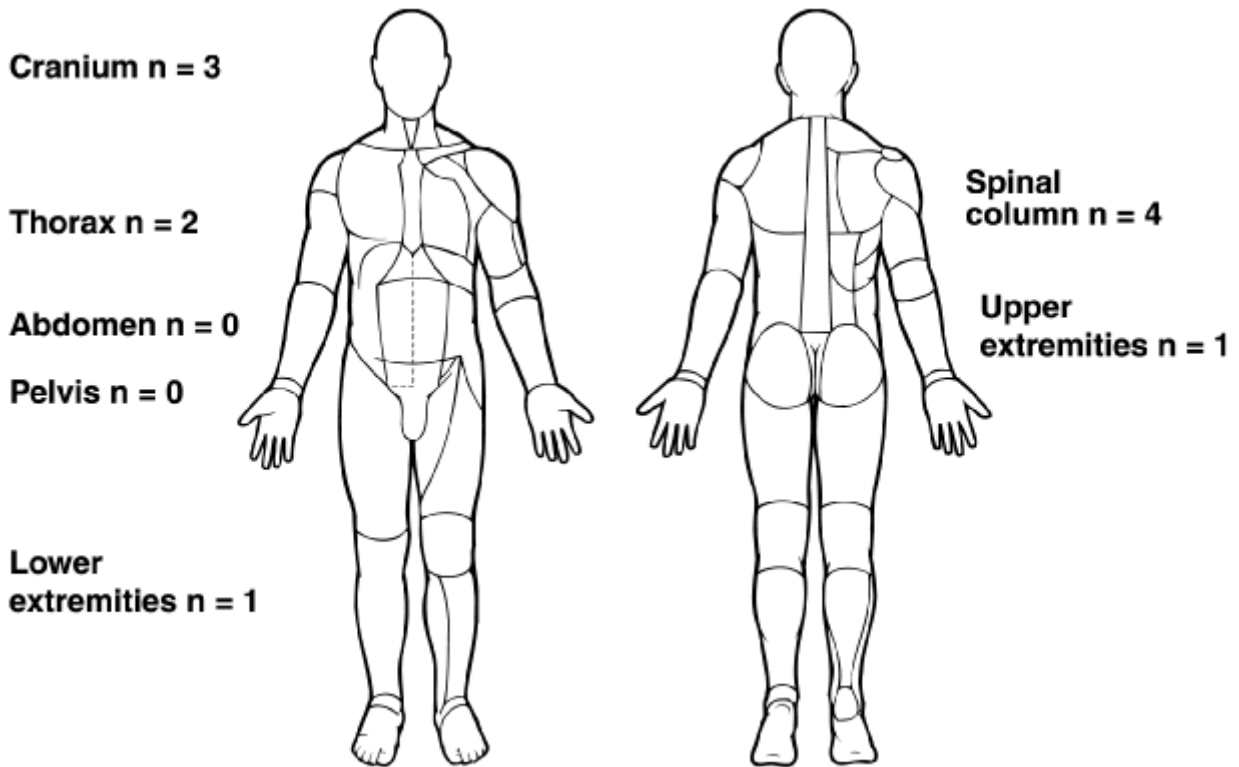

N00.00-2749-00

Source: Dr. med. Rainer Zinser (Oberschwabenklinik Hospital, Ravensburg)

## The golden hour of shock

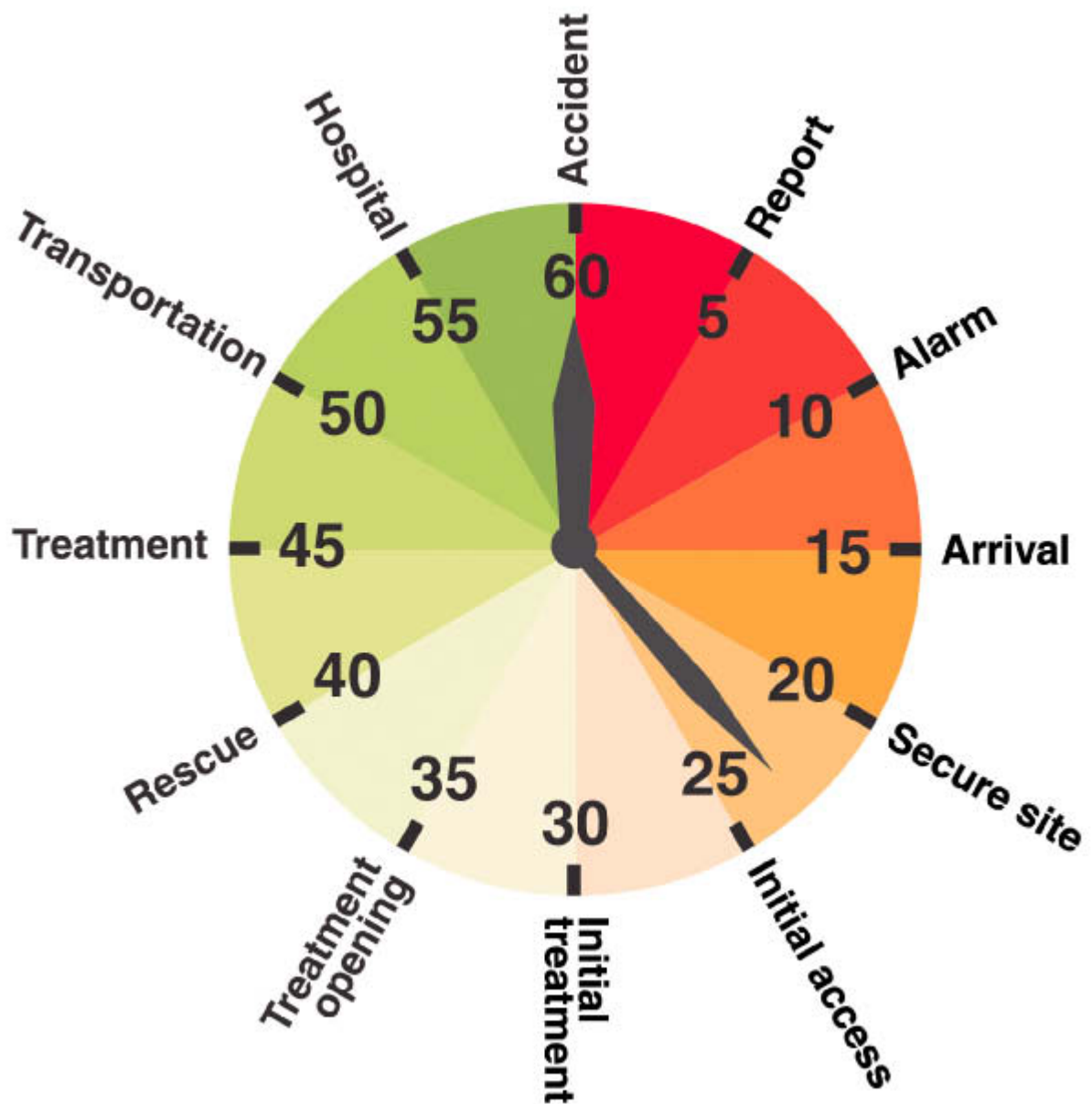

N00.00-2750-00

### *The golden hour of shock*

#### The "golden hour" of shock (60 min)

This term describes the time period within which the casualty, whether from a passenger car or a truck accident, should be brought to the hospital following an accident. Within this time the casualty has the best chances that his condition will not deteriorate significantly.

## Procedure in four phases

For proper casualty rescue from trucks, as also from passenger cars, the operation should be divided into four phases:

1st phase: "initial opening"

2nd phase: "treatment opening"

3rd phase: "rescue opening"

4th phase: "rescue of the casualty"

### 1st phase "initial opening"

In the 1st phase the accident situation is assessed by the crew chiefs and then an access route is made for the emergency physician to conduct an initial evaluation. The purpose of this is to ascertain the overall condition of the casualty. The fire crew at the scene and the medical team under the command of the emergency physician should remain in close contact with each other for the duration of the rescue operation.

Initial access merely requires openings that are large enough to allow a check of the casualty's vital functions and an assessment of the situation inside the vehicle.

Depending on the degree of deformation of the cab, it may still be possible to open the doors. This should always be checked first, as it will facilitate the rescue of the casualty.



*Initial assessment, e.g. through the side windows or the windshield*

#### Risk of injury

When **disconnecting** batteries or **cutting the cables**, disconnect the ground line first otherwise there is a **risk of short circuit**.

If **short circuits** occur, there is a **risk of injury** from an **electric shock** due to the **higher voltage and current** of truck batteries. **Sparks** or the **overheating** of electrical components due to **short circuits** can cause **flammable substances to ignite**. Any resulting **fire** or **deflagration** poses an acute **risk of injury** for occupants and rescuers alike.

#### Measures

**If this is not possible, insulated tools must be used to disconnect or cut the cables. If no insulated tools are available, insulate the appropriate places by covering them with suitable materials.**

**Wear protective clothing/safety glasses.**

**Ensure that sufficient quantities of fire extinguishing agents are at hand.**

Simultaneously all the necessary preliminary measures are in progress. The scene of the operation must be secured, and this involves:

- Securing the site
  - Protection from moving traffic
  - Protection against fire by provision of suitable extinguishing agents
  - Protection against danger from the cargo (hazardous goods, cargo shifting etc.)
- Protecting against movement of the vehicle:
  - Chocking the wheels to prevent movement
  - Stopping the engine if it is still running
- Disconnecting the battery
- Collecting escaping fluids

## Tactical procedure



### Risk of injury

On vehicles with the appropriate equipment, disconnecting the battery can cause the pneumatically adjustable seats to move down.

Any uncontrolled movement of an injured casualty represents a further risk of injury.

### Measures

This measure should only be performed in consultation with the emergency physician.

### 2nd phase "treatment opening"

The preliminary measures are followed by emergency medical treatment. The emergency physician makes the casualty ready to be rescued. Access through the windshield, for example, using a scaling ladder section is sufficient for this purpose. The size of the cab usually provides enough space for the emergency medical team for rescue work. When this phase is complete, the emergency medical team starts to render initial medical aid in order to allow the casualty to be rescued safely.



*Access via a scaling ladder section*

### 3rd phase "rescue opening"

In most cases the casualty will be rescued via the driver door. The door is removed using heavy equipment such as hydraulic spreaders and rescue shears. The rescue opening is enlarged by pushing away the front end with telescopic rescue rams. This procedure is described in more detail in the following chapter "Proper casualty rescue".



*Rescue opening via the driver door*



### 4th phase "rescue of the casualty"

When the opening is large enough, the casualty is rescued and transported out of the cab in close consultation with the emergency medical team. In this part of the rescue, the emergency physician alone dictates the speed and manner of the rescue work.



## Initiation

### Rescuing the casualty from the cab

Whereas formerly priority was given to quickly rescuing the trapped casualty from his predicament, the primary concern nowadays is medical and psychological assistance. The aim of this is to prepare the casualty as well as possible for the rescue work. The medical and rescue personnel can then work in concert to free the casualty.

The main priority is to render medical and psychological aid to the casualty!

The most urgent immediate measures are:

- Maintaining or restoring the vital functions (respiration/circulation)
- Keeping the respiratory passages clear and removing respiratory obstructions (clear the mouth and throat, bend the head back slightly and give artificial respiration if necessary)
- Stopping severe bleeding (by holding up the affected body part, pinching off the appropriate artery and applying a pressure bandage if necessary)
- Treating life-threatening injuries
- Assessing shock and initiating measures to stabilize the casualty
- Immobilizing certain body parts
- Rendering psychological support to the casualty

Proper casualty rescue means freeing the casualty from the accident vehicle as safely as possible without causing additional harm or exacerbating his injuries. In the process, all unnecessary movements of the accident vehicle should be avoided because the trapped person is in direct contact with the vehicle. The medical and rescue personnel work in concert to free the casualty. However, the safety of the medical and rescue crews themselves should not be neglected at any time during the rescue.

The casualty should only be freed from the accident vehicle immediately when there is an imminent risk to the casualty's life, e.g. in the following cases:

- Vehicle on fire
- Serious danger from hazardous substances
- Danger of hazardous drop
- Imminent cardiac failure with no possibility of treatment inside the vehicle

In this case the situation calls for "CRASH RESCUE".

#### **i** Note

Contact between the fire and rescue crews should be maintained at all times; they should be in constant communication!

All measures should only be performed in consultation with the emergency physician!

### Assessing the accident situation

The assessment should include the following aspects:

- Evaluation of the danger to the rescue team itself (protecting the scene of the accident, hazardous goods, airbags, escaping fluids, etc.)
- The extent of the accident site and the number of vehicles or casualties involved
- Coordination with other rescue crews
- Position reporting and definition of priorities
- Are the crews on hand sufficient?

### Via the doors

It should first be checked whether access via the doors is possible. If the deformation of the cab is slight, it is often still possible to open the doors by hand or using small tools such as screwdrivers or crowbars.

Heavy hydraulic tools should only be used after the above check has been performed.



*Opening doors by hand or with small tools*

### Via the roof hatch

An alternative way of gaining access to the cab is via the roof hatch. As this may be electrically operated, the hatch should only be used if it is already open. (This may require too much time if there are other or better alternatives.)

If the vehicle is lying on its side, however, it may indeed be easier to use the roof hatch as the initial access point even if it is closed. In this case the hatch must be removed or an opening cut in the glass or metal plate.

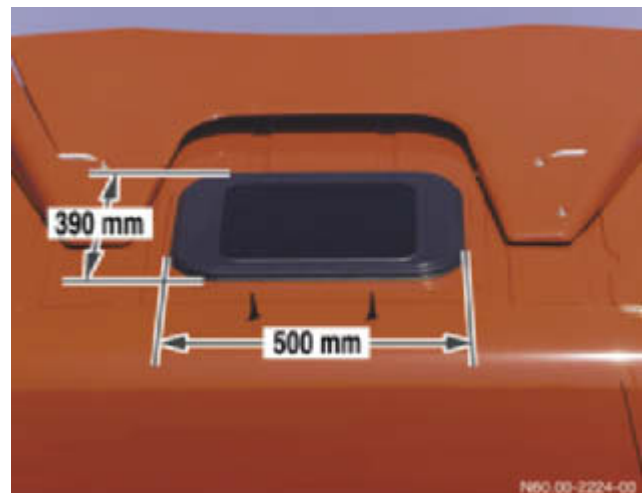

*Potential access via roof hatch*



#### Risk of injury

When vehicle parts are **cut open** or **cut off from the vehicle**, sharp edges are produced with the potential to cause **injury** to both rescue personnel and the casualties inside the vehicle.

#### Measures

**Cover any sharp edges with suitable tarpaulins**



## Initial access

### Via the rear wall

If no access is possible via the alternatives described above, e.g. if several vehicles are wedged together, it may be possible to gain access to the cab via the rear wall. If there are rear windows, access should be through these.

If there are no rear windows, a hole must be drilled/punched in the sheet metal. An opening can then be cut, torn or sawn starting from the hole. To gain access to the rear wall of the cab, it may be necessary to remove the side walls beforehand. On semitrailer tractors it may also be necessary to uncouple the trailer and secure it to prevent it from moving.



*Potential access via rear window*



#### Risk of injury

When vehicle parts are **cut open** or **cut off from the vehicle**, **sharp edges** are produced with the potential to cause **injury** to both rescue personnel and the casualties inside the vehicle.

#### Measures

**Cover any sharp edges with suitable tarpaulins.**

### Use of the initial access opening

Through the initial access opening the casualty is treated in the cab by a qualified member of the rescue crew, who commences the initial diagnostic and medical work. In doing so, great importance should also be given to his own safety.



#### Note

Never move inside the range of an airbag or other restraint systems unless they have already deployed.

### Securing the site

In Germany, the scene of the accident must be secured in accordance with the pertinent fire service regulation (FwDv 13/1).

### Fire protection

Protection against fire is guaranteed by the provision of sufficient quantities of suitable extinguishing agents. The fire extinguishers must be constantly manned in order to ensure that they are ready for action quickly. It may be necessary to employ powder, foam and water to contain the fire and stop it spreading.

### Securing traffic

The scene of the accident is protected from moving traffic by parking the rescue vehicles in a certain arrangement and by using the appropriate equipment. Details of this can be found in the regulations GUV 27.1-C6 and FwDV 1/2.

### Securing the vehicle

Secure the vehicle to prevent it from rolling away (stop the engine if necessary - see next paragraph), from tipping over and from moving in any other way.

In addition, the safety of the cargo should not be neglected, especially in the case of hazardous goods. Escaping fluids are collected by appropriate means.

Regulation FwDv 13/1 also stipulates how to secure the scene in darkness. If the light level is too low, the scene must be adequately illuminated.

## Stopping the engine

Diesel engines may continue to run after an accident. The engine can be stopped by several methods, depending on the situation and the severity of the accident.

### Ignition key

If the ignition switch can be reached, an attempt should be made to stop the engine by switching off the ignition.

### CO<sub>2</sub> fire extinguisher through the air intake

Another method that has proved effective in practice is to stop the engine via the air intake. This involves blowing CO<sub>2</sub> into the air intake. The CO<sub>2</sub> displaces the oxygen required for combustion. Due to the lack of oxygen, the fuel/air mixture in the engine cannot ignite. The engine dies.

### Variants of air intake

#### Air intake (Actros, Axor)

The air intake in this case is located on the right-hand side of the vehicle on the cab rear wall. First, the rubber boot must be lifted in order to create an opening. CO<sub>2</sub> is blown into the bottom half using a fire extinguisher. The engine no longer receives sufficient oxygen and so it stops.



Blowing CO<sub>2</sub> into the air intake



Rubber boot (arrow)

### Front air intake (Atego)

The air intake here is located behind the radiator grille. The CO<sub>2</sub> cannot be injected directly because there is no access to the air intake. The CO<sub>2</sub> is sprayed through the radiator grille in the direction of the air intake using a fire extinguisher.

**i** **Note**

Make sure there are sufficient CO<sub>2</sub> fire extinguishers available, and spray from both sides (from left and right) simultaneously.

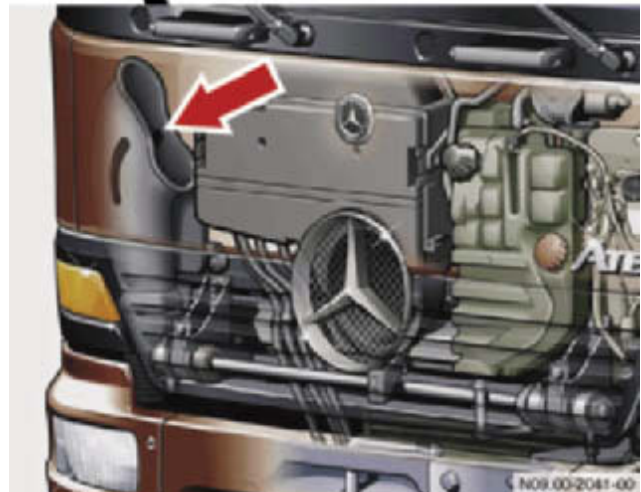

*CO<sub>2</sub> injection point (arrow) at air intake*



*Air intake - air filter*

## Stopping the engine

**! Fire hazard!**

Escaping fuel is **inflammable** and can be ignited by **sparks** or **open flames**.

**Measures**

**Collect escaping fuel by suitable means.**

### Removing a fuel line

If the cab is torn off, the engine can be stopped by clamping off or cutting the fuel lines. Escaping fuel must be collected immediately because of the possible risk of fire. The engine continues to run until the fuel inside the fuel filter and the feed line has been consumed. But this can take up to 10 min.

**i Note**

Fuel lines should be removed only in exceptional cases. The method using the CO<sub>2</sub> fire extinguisher is preferable.





### Advantage

Reducing the rescue height makes it easier for the rescue team to work on the cab (even when a rescue platform is available) and facilitates the subsequent rescue of the casualty.

The following options are available:

- Cab mounting air suspension
- Front axle air suspension
- Tire inflation pressure

 Risk of injury	Measures
<p>When <b>air lines</b> are <b>cut</b>, the cut ends can fly around violently and cause <b>injuries</b>.</p> <p>When a bellows is <b>pierced</b>, flying parts may constitute a <b>risk of injury due to high pressure</b>.</p>	<p><b>Perform these steps with the utmost care.</b></p> <p><b>Keep a safe distance.</b></p> <p><b>Wear protective clothing.</b></p>

 Risk of injury	Measures
<p>When the vehicle is <b>lowered</b>, the injured occupant may possibly be subjected to <b>uncontrolled movements</b> which could pose an additional <b>injury risk</b>.</p>	<p><b>The vehicle should only be lowered in consultation with the emergency physician.</b></p>



## Reducing the rescue height

### Lowering the air suspension

If the vehicle is equipped with cab air suspension, this can be lowered. This reduces the rescue height and immobilizes the cab. The rescue height is the height that must be overcome in order to move the casualty from his seat to the ground.

The air can be released by two different methods:

#### Cutting the air lines

It is preferable to cut the line to the air bellows. The line must be cut between the bellows and the valve.



*Cutting air line at air bellows*

#### Piercing the air bellows

Another alternative is to pierce the air spring bellows using a spike or similar implement (caution: risk of injury). This must be done carefully.

An appropriate safety distance must be maintained because the bellows is under high pressure. The air bellows may burst when pierced. Flying parts constitute an injury risk!



*Cab mounting air bellows (1)*



### Releasing the tire pressure

The rescue height can be reduced by unscrewing the tire valves. This measure can lower the vehicle by about 150 mm. The tires should never be destroyed (punctured etc.) as this makes salvaging the vehicle more difficult.



*Unscrewing the valve to deflate the tire*



## Reducing the rescue height

### Frame air suspension

Some vehicles feature full air suspension, i.e. the chassis is equipped with an air suspension system. By far the most common variant is that with air suspension on the rear axle only. On vehicles with full air suspension, the rescue height can be reduced by lowering the air suspension. There are three possible alternatives.

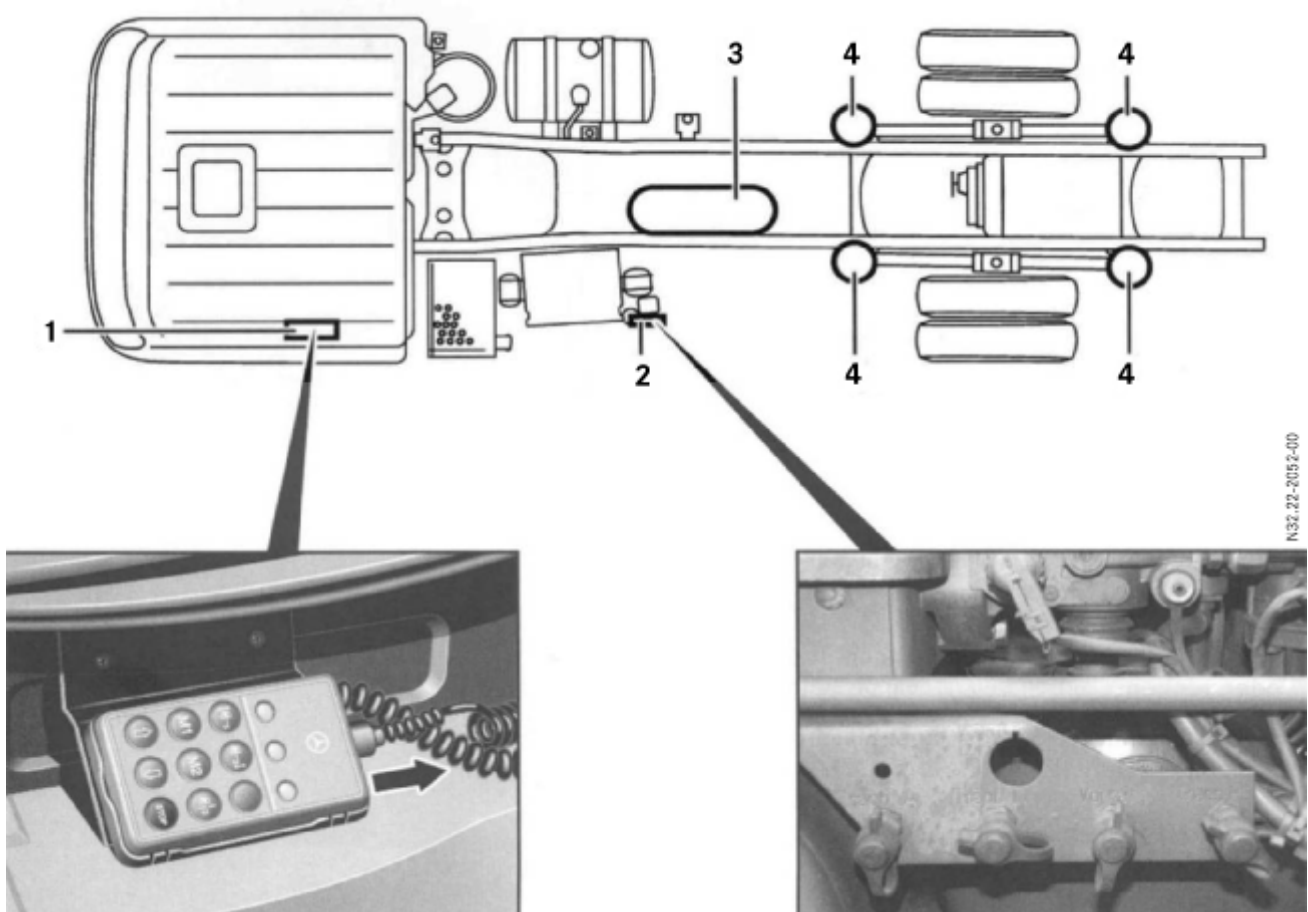

- 1 Operating unit
- 2 Tire inflation connection and air suspension test connection
- 3 Compressed air reservoir
- 4 Spring bellows

## Lowering with the operating unit

This method requires that the key in the steering wheel lock is in the "drive" position and that the battery is still connected. The vehicle must have been secured beforehand to prevent it from rolling. This can be done via the parking brake, for example, but is better accomplished using wheel chocks.

**Warning!**

The vehicle should only be lowered in consultation with the emergency physician.

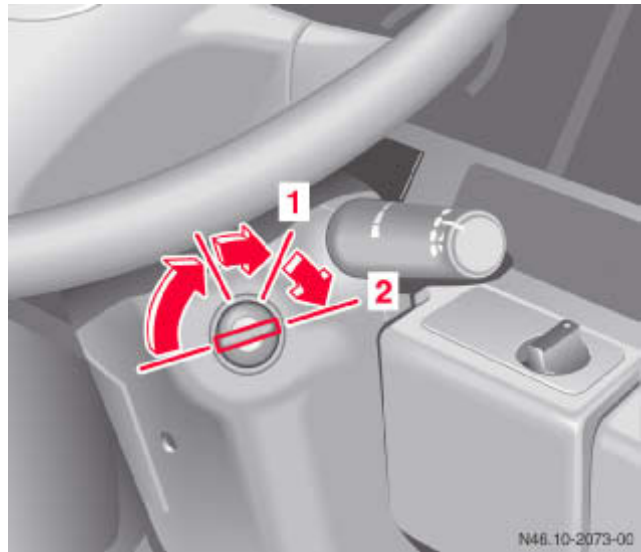

**Steering wheel lock**

- 1 Drive position
- 2 Start position

In order to lower the chassis, use **button 3** (front chassis frame) or **button 4** (rear chassis frame) on the operating unit to select the axle to be lowered or raised. The **indicator lamps 1** and **2** show whether front (1) or rear (2) is selected. **Button 9** (down arrow) can now be used to lower the chassis frame in the preselected area (front or rear). The process can be interrupted by pressing the **Stop button** (10).



N32.22-2053-00

**Operating unit**

- 1 Indicator lamp for front chassis frame
- 2 Indicator lamp for rear chassis frame
- 3 Front chassis frame
- 4 Rear chassis frame
- 8 Raise chassis frame
- 9 Lower chassis frame
- 10 Stop (raising/lowering)

## Reducing the rescue height

### Lowering the chassis frame via the test connections

Another non-destructive way of letting the air out of the air suspension is to release it via the test connections. In order to lower the chassis frame, the valves must be vented (this can be done using a tire inflating hose).

To raise or lower the chassis at the **front axle**:  
Pressurize or vent via test connection 1.

To raise or lower the chassis at the **rear axle**:  
Pressurize or vent via test connections 2 and 4.

#### **Warning!**

The vehicle should only be lowered in consultation with the emergency physician.

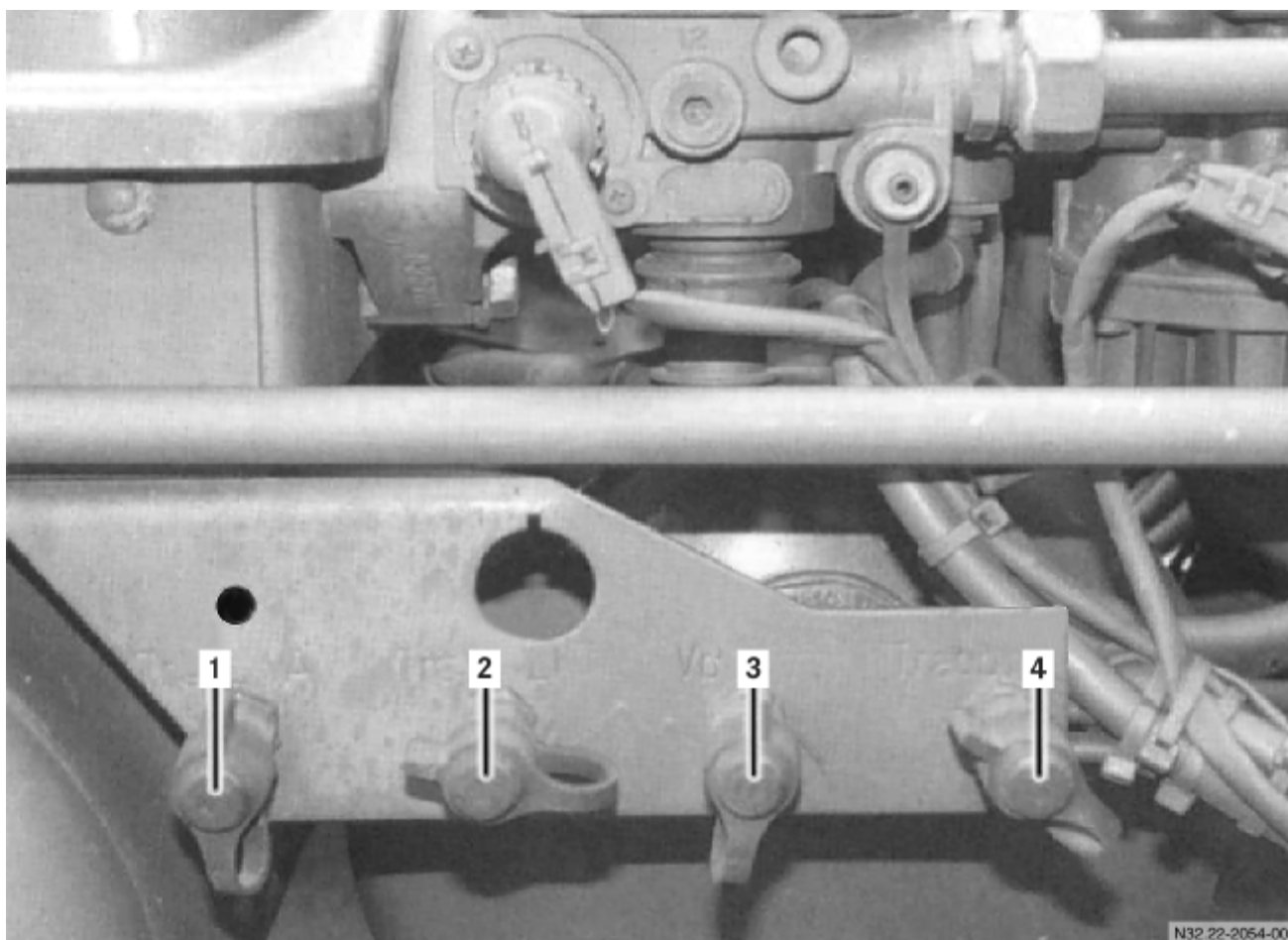

#### **Test connections**

- 1 Front axle
- 2 Left rear axle
- 3 Air suspension supply (external filling)
- 4 Right rear axle

### Work platform

For the next phase it is necessary to use a work platform (to bridge the height from the road to the cab) in order to facilitate the work of the rescue crews and enable the rescue to be carried out. There are various options for this. For example, rescue platforms in a wide variety of forms are available.

However, the lift gates of trucks, cargo beds on vans, turntable ladders with or without basket, and even pieces of cargo from the accident vehicle's own cargo can all be used as a platform.



*Scaffold*



*Vehicle with lift gate*



*Turntable ladder with or without basket*



*Flatbed*



## Securing the cab

### Preparing the cab

To ensure that no further harm comes to the casualty during the rescue, he should not be subjected to any unnecessary movements if at all possible. Consequently, the cab suspension and the suspension between the frame and the axle must be rendered inoperable or bypassed in order to prevent the cab from moving.



### Securing the cab

In order to prevent any undesirable movements of the cab, it should be lashed fast to the frame by means of a strap passed around the cab and under the frame. This measure prevents the cab from slipping if the cab mounting is destroyed and stops any unnecessary movement of the cab.

In most cases further shoring up of the cab to prevent possible movement is no longer absolutely necessary after this measure.



*Strap around frame and cab*

 <b>Risk of injury</b>	<b>Measures</b>
<p>Always remove the <b>windows</b> when working on adjacent components. <b>Windows</b> may <b>shatter</b> resulting in tiny, sharp <b>glass particles flying around</b> which may cause <b>injury</b> to the occupants and rescuers.</p>	<p><b>Cover the occupants before commencing work.</b></p> <p><b>Always wear protective clothing/safety glasses.</b></p> <p><b>Cover any sharp edges with suitable tarpaulins.</b></p>
 <b>Risk of injury</b>	<b>Measures</b>
<p><b>Shards of glass</b> on the road in front of the vehicle present a <b>risk of slipping</b> when positioning the <b>scaling ladder!</b></p> <p>If the ladder <b>slips</b> or <b>topples over</b>, the rescuers may suffer <b>injuries</b>.</p>	<p><b>Remove shards of glass from the road in front of the vehicle before positioning the scaling ladder.</b></p>

## Windows

There are two types of windshield:

- Windows held in a rubber seal
- Cemented windows

### Windows held in a rubber seal:

If the windshield glass is intact, slit open the rubber seals with a firefighter knife. Pull off the rubber seal. The window is now loose and can be removed.

In some kinds of accident it is possible that the entire windshield has already fallen out due to the force of the impact. In these cases the windshield opening can be used as an initial access point immediately using a section of ladder.

### Cemented windows:

Several methods of removing cemented windows have become established from the passenger car sector. One method is to cut out the window using a **glass saw**.

An opening is first knocked in the glass well away from the hazard area around the casualty (risk of injury).

The casualty is barely exposed to any glass fragments inside the vehicle, but should be covered with a tarpaulin or blanket for safety.

This method is only advisable on trucks when the cab has been secured to prevent it from rocking. The back-and-forth movement of the tool causes the cab to sway. This subjects the casualty to substantial movements. Exception: The cab and frame suspension has already been rendered inoperable. (See "Securing the cab".)



## Glass handling

Another way of removing a cemented window is to use a **hooligan metal cutter tool**. It is used in a similar way to the glass saw. It causes less splintering and produces less glass dust than the glass saw. One disadvantage is the edge of the cut. It is coarser and less clean.

This method subjects the cab to hardly any rocking movement because the tool does not need to be moved back and forth to cut the window. First, a hole is knocked in the window (away from the hazard area around the casualty). Then, starting from this hole, the window is ripped open all round. Once cut, the windshield can be removed.

A large pair of **plate shears** is another alternative. A hole is knocked in the bottom of the window at a safe distance from the casualty, and the window is then cut open.

### Removing the glass

Windows in parts adjacent to those being worked on must always be removed before using hydraulic tools. This applies above all to the windows in the doors. If the windows are not removed, they will be subjected to considerable pressure, as will the parts which you are attempting to spread.

At a certain compressive force the windows will be unable to withstand the pressure and will burst suddenly and violently. Tiny, sharp glass fragments will be sent flying. These fragments can inflict injuries; they spread around the area of the accident, posing an acute danger of cuts.

#### Note

Truck windshields have a relatively high dead weight and can weight up to 35 kg.

Tools for cutting open laminated glass windows



N67.00-2028-00

*Large plate shears*



N67.00-2029-00

*Glass saw*



N67.00-2030-00

*Spring punch*



N67.00-2031-00

*Hooligan tool*

## Glass handling

### Removing windows using a spring punch

Windows made of single-pane safety glass (side windows and rear windows) can be removed using a spring punch:

The window to be removed is covered all over with a self-adhesive film or adhesive tape. Then a spring punch is used to punch one corner of the window. The window shatters into small shards which are held together by the film or adhesive tape applied beforehand. The shattered window is carefully removed from the interior compartment.

The method of using adhesive tape and a packing tape roll dispenser has proven particularly effective. This is a quick and inexpensive way of removing single-pane safety glass. If the window is wet, it should be dried first otherwise the moisture on the window will prevent the tape from adhering properly.

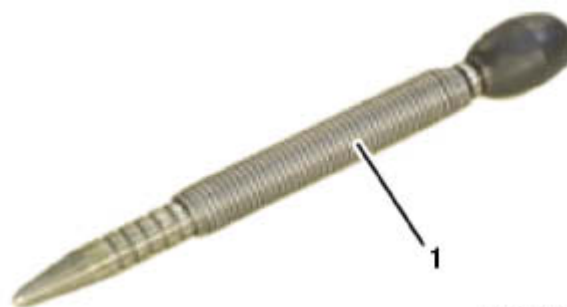

1 Spring punch

N67.00-2032-00

 Risk of injury	Measures
<p>Windows may shatter resulting in tiny, sharp <b>glass particles flying around</b> which may cause <b>injury</b> to the occupants and rescuers.</p>	<p><b>Before working on the door, all windows must be removed from the door and from adjacent components.</b></p> <p><b>Because of its high dead weight it is absolutely essential that the door is adequately secured to prevent it from falling.</b></p> <p><b>Always wear protective clothing/safety glasses.</b></p>

Before gaining access via the door, all windows must be removed from the door and from adjacent components. Truck doors are extremely heavy (approx. 80 kg) and must be secured to prevent them from falling before work is performed on them. This can be done using a multipurpose rope, for example. A rope is fastened to the cab door with a knot and laid across the cab. The door is then held on the other side by two crewmen.



*Securing the door with a rope*

## Removing the door

### Removing the door with a spreader

When the preparatory measures on and around the door are complete, the door can be forced out. The tip of the spreader is inserted in the gap between the A-pillar and the door. The crewman works the spreader in the direction of the hinges. When these two points are reached, the tip of the spreader is repositioned and the door is forced away. Forcing the door away either causes the strap hinges to tear or rips out the riveted joints.

Securing the door with the rope beforehand prevents the door from falling, as it would otherwise do due to its high dead weight. To release the last attachment point, operate the door lock.

The door is now no longer connected to the cab. It can be lowered carefully to the ground using the rope and then moved away from the work area.





## Pushing away the front end

To free a trapped casualty it is usually necessary to enlarge the space between the waistrail (dash support, steering unit, pedals) and the seat. Adjusting the steering wheel can provide initial relief for the driver in the areas of the chest and abdomen. In some cases simply adjusting the seat towards the rear is enough to free the casualty, or at least to ease his situation to some degree.

### Relief cuts

Relief cuts must be made in the bodywork of the cab to allow the front end to be pushed forwards.

### Cutting method

The first relief cut should be made in the upper third of the A-pillar approx. 200 mm below the top edge of the windshield, because there are no reinforcements or gusset plates from the roof structure welded on at this point.

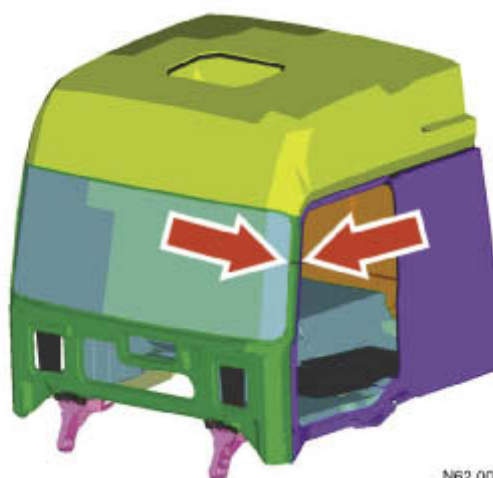

*First relief cut in the upper third of the A-pillar*

## Pushing away the front end

The second relief cut should be made in the rocker panel between the A-pillar and B-pillar at a distance of at least 200 mm from the A-pillar. There are no reinforcement brackets or gusset plates installed here.

As the rocker panel is relatively tall, it is advisable to crush it using a spreader before cutting (especially if using small rescue shears or rescue shears with short blades). After crushing it, first make a V-shaped cut in the rocker panel and then cut all the way through the rocker panel in the middle of the V-cut (to make a Y-shaped cut). This ensures that the rocker panel is severed completely.

**i Note**

- First relief cut in the upper third of the A-pillar
- Second relief cut in the front third of the rocker panel between the A-pillar and B-pillar



*Crushing the rocker panel*

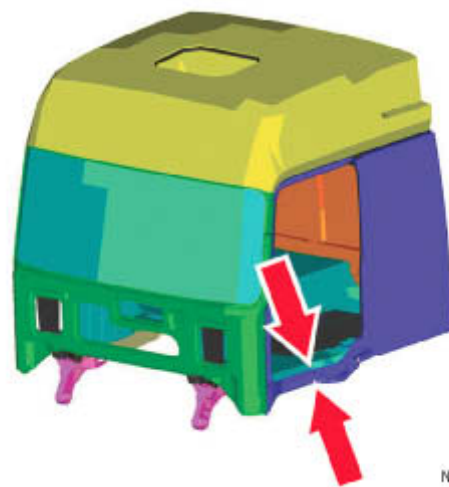

*Cutting the rocker panel*

### Use of telescopic rescue ram

After making the relief cuts in the A-pillar and the rocker panel, the 1st rescue ram is clamped between the A- and B-pillars level with the dashboard/upper door hinge and the door lock.

The installation point on the B-pillar should be in the area of the door lock because here the pillar is capable of withstanding the maximum force. The dash support and with it the steering wheel and the steering column are pushed forward on one side with the rescue ram until there is sufficient space to rescue the casualty.

If the distance is inadequate, the next largest rescue cylinder must be fitted above the first. Only then can the first rescue ram be removed.

#### Risk of injury

To prevent the parts from springing back, the first rescue ram (across the door) must not be removed until the second ram has been installed and extended.

Make sure the second rescue ram is securely seated between the upper and lower window flanges in order to ensure that the ram does not slip out of place.



*Relief cuts (arrows)*





## Pushing away the front end

In this position the rescue ram may obstruct the rescue of the casualty. If this is the case, an additional rescue ram should be clamped between the upper and lower windshield flanges. Then the first ram can be removed, and the way is clear to rescue the casualty. This measure should only be employed if there is a substantial impediment to extricating the casualty from the cab.

The door opening may be so badly deformed due to the crash that it may be necessary to use rescue rams of different sizes to enlarge the opening.

### **i** Note

All action should only be performed in close consultation between the fire brigade and the rescue crew.



 Risk of injury	Measures
<p>When <b>disconnecting</b> batteries or <b>cutting the cables</b>, disconnect the ground line first otherwise there is a <b>risk of short circuit</b>.</p> <p>If <b>short circuits</b> occur, there is a <b>risk of injury</b> from an <b>electric shock</b> due to the <b>higher voltage and current</b> of truck batteries.</p> <p><b>Sparks</b> or the <b>overheating</b> of electrical components due to <b>short circuits</b> can cause <b>inflammable substances to ignite</b>. Any resulting <b>fire</b> or <b>deflagration</b> poses an acute <b>risk of injury</b> for occupants and rescuers alike.</p>	<p><b>If this is not possible, insulated tools must be used to disconnect or cut the cables. If no insulated tools are available, insulate the appropriate places by covering them with suitable materials.</b></p> <p><b>Wear protective clothing/safety glasses.</b></p> <p><b>Ensure that sufficient quantities of fire extinguishing agents are at hand.</b></p>

 Risk of injury	Measures
<p>There is a <b>risk of injury</b> in the <b>deployment area</b> of undeployed <b>airbags</b>.</p> <p>If, <b>before the battery is disconnected, severe shocks</b> occur in the vicinity of the driver seat and the cab longitudinal member (location of the airbag control unit), or electrical lines or the steering column are cut, it is possible that <b>an airbag</b> or <b>emergency tensioning retractor</b> may be triggered. If this happens, <b>loose objects</b> or <b>glass splinters</b> may be thrown or pressed onto the casualty or the rescuers, causing <b>injuries</b>.</p>	<p><b>Cover the occupants before commencing work, preferably with a transparent sheet.</b></p> <p><b>Wear protective clothing/safety glasses.</b></p> <p><b>Disconnect all batteries. If this is not possible, keep well away from undeployed airbags.</b></p> <p><b>Do not perform cutting work near undeployed airbags.</b></p> <p><b>Avoid heating near undeployed airbags.</b></p> <p><b>Do not place any objects near undeployed airbags.</b></p>

 **Note**  
 Merely cutting through the steering wheel rim or the spokes will not usually trigger the airbag.

 **Note**  
 Most airbag systems are designed so that they can no longer be triggered by the airbag sensor systems after the battery has been disconnected and a short waiting period has elapsed.



## Airbag

 Risk of injury	Measures
<p>If using <b>safety devices</b> intended to protect against <b>airbag deployments</b> after an accident, there is a <b>danger</b> that these devices may be <b>catapulted</b> by the deploying airbag, presenting an additional <b>injury hazard</b> for the casualty and the rescuers. So-called "<b>safety devices</b>" that are intended to prevent a pressure buildup by piercing holes in the airbag fabric <b>must not be used</b> because, if triggered, the <b>hot ignition gases</b> can escape unhindered and cause extremely serious <b>burns</b>.</p>	<p><b>Cover the occupants before commencing work, preferably with a transparent sheet.</b></p> <p><b>Wear protective clothing/safety glasses.</b></p> <p><b>Disconnect all batteries. If this is not possible, keep well away from undeployed airbags.</b></p> <p><b>Do not perform cutting work near undeployed airbags.</b></p> <p><b>Avoid heating near undeployed airbags.</b></p> <p><b>Do not place any objects near undeployed airbags.</b></p>

 Risk of injury	Measures
<p>From <b>contact with the airbag</b>, occupants may suffer slight <b>reddening of the skin</b> and <b>abrasions</b>, e.g. on the insides of the forearms or on the chin, due to the necessary high deployment speed. Slight <b>irritation of the respiratory passages</b> cannot be ruled out.</p>	<p><b>The condition of the casualties must be assessed as accurately as possible before deciding on further precautionary measures.</b></p>

 **Note**

The white, powdery residues left inside the vehicle after deployment of an airbag are non-toxic. They consist for the most part of talcum, which acts as a lubricant for the airbag fabric!

## Overview

A driver airbag, identifiable by the "SRS" logo on the padded boss of the steering wheel, in combination with an emergency tensioning retractor is available as a restraint system (special equipment) for Mercedes-Benz trucks. An emergency tensioning retractor in the backrest of the driver seat or front passenger seat is only possible when an airbag is installed. If the airbag system has deployed following an accident, there is no more danger to the casualty and the rescue personnel from an inflating airbag.

## Undeployed airbags

In cases where the rescue or treatment of casualties has to be carried out within the deployment radius of untriggered airbag systems (e.g. if the casualties are trapped or their injuries require immediate treatment), the following points must be observed:

- Switch off ignition!  
**Note: Consultation with the emergency physician is essential because the seat may move downwards under certain conditions.**
- Disconnect cables from battery  
**Note: Consultation with the emergency physician is essential because the seat may move downwards under certain conditions.**
- Do not perform cutting work near the airbag units concerned!
- Avoid overheating the area around the airbag unit, such as in the vicinity of the steering wheel impact plate. If an airbag unit is heated, e.g. by fire, to **over 160 °C, it is likely to be triggered!**
- Do not place any objects near undeployed airbags!
- Exercise caution when cutting the driver seat backrest frame (emergency tensioning retractor)!



*Undeployed airbag*



*Deployed airbag*

## Airbag

### General

The airbag, identifiable by the word "AIRBAG" or "SRS" (Supplemental Restraint System) embossed on the padded boss, is integrated in the steering wheel under the padded boss. The seat belt system for the driver can be supplemented with an emergency tensioning retractor. This is located at the seat belt attachment points inside the seat.

In the event of a collision with a precisely defined deceleration, the airbag control unit triggers a number of propellant charges. One propellant charge deploys the airbag while another charge activates the emergency tensioning retractor and pulls the seat belt as tight as possible across the driver's body.

### EMERGENCY OFF switch

Vehicles used for transporting hazardous goods are equipped with two manual EMERGENCY OFF switches. This facility is also available for other vehicles as special equipment.

The switches are used to interrupt the voltage supply in an emergency and to prevent short circuits and sparks which may ignite a fire or an explosion.

One EMERGENCY OFF switch is mounted on the instrument panel in the cockpit; the second is on the passenger side behind the cab.

### Undeployed airbags

In cases where the rescue or treatment of casualties has to be carried out within the deployment radius of untriggered airbag systems (e.g. if the casualties are trapped or their injuries require immediate treatment), the following points must be observed:

- Switch off ignition!  
**Note: Consultation with the emergency physician is essential because the seat may move downwards under certain conditions.**
- Disconnect cables from battery  
**Note: Consultation with the emergency physician is essential because the seat may move downwards under certain conditions.**
- Do not perform cutting work near the airbag units concerned!
- Avoid overheating the area around the airbag unit, such as in the vicinity of the steering wheel impact plate. If an airbag unit is heated, e.g. by fire, to **over 160 °C, it is likely to be triggered!**
- Do not place any objects near undeployed airbags!

#### Note

Switching off the ignition and disconnecting or cutting the battery cables should only be done in consultation with the emergency physician!

## Function of airbag

The driver airbag unit (1) is located in the steering wheel (4) and essentially consists of the padding (3), the air sack and the gas generator (5).

The gas generator contains the solid fuel (2) in tablet form (sodium azide or azide-free depending on the year of manufacture). When the airbag control unit delivers an appropriate pulse (ignition energy) via the slip rings or the clock spring contact to the squib inside the gas generator, the solid fuel in the gas generator is ignited. In general, driver airbags with a one-stage gas generator are used.

The fuel burns within a very short time, developing a defined volume of gas under a defined (very high) pressure.

The gas is directed into the air sack through filters. The nylon fabric air sack folded on top of the gas generator tears open the padding of the cover at a predetermined fracture point. The air sack is filled with gas within a few milliseconds. As he moves forward opposite the impact direction, the occupant comes into contact with the inflated air cushion, which reduces his forward speed. The front airbags substantially reduce the risk of head, neck and chest injuries if the occupant is wearing a seat belt.

The gas quickly escapes from the air sack through the blow holes or the filter, and the air cushion collapses.

As the solid fuel burns off, the gas generator heats up, but not the steering wheel.

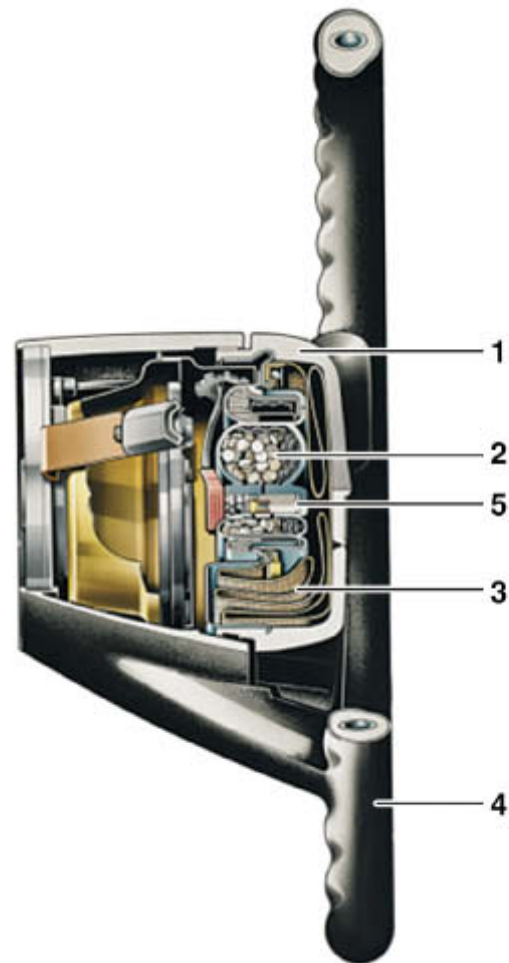

P91.60-2149-00

### **Driver airbag**

- 1 Driver airbag unit
- 2 Solid fuel
- 3 Padding
- 4 Steering wheel
- 5 Gas generator

## Seat belt/emergency tensioning retractor

### Design and function

The seat belt buckles can usually be opened normally after a crash. However, it is often easier to cut the belts at an easily accessible point. In this way the rescue crew do not need to lean over the casualty, which might cause further discomfort or injury.

In Mercedes-Benz commercial vehicles, emergency tensioning retractors are only supplied in combination with an airbag.

In the event of a collision, the emergency tensioning retractor tightens the seat belt so that it fits snugly on the body and optimizes the protection function of the seat belt.



*Emergency tensioning retractor*

NB1\_40-2132-00



### Variants

Adjusting the steering wheel can provide relief for the driver in the areas of the chest and abdomen.

Three variants of steering wheel adjustment are possible.

### Manual release

To operate, flip out the lever and adjust the steering wheel



*Manual release*

### Manual release with locking mechanism

This variant incorporates a locking mechanism (1). This must be operated first in order to be able to flip out the lever to release the steering column.



*Manual release with locking mechanism*

1 Locking mechanism

## Steering wheel adjustment

### Pneumatic lock

In the most recent variant, the adjustment facility is secured to prevent unintentional adjustment of the steering wheel by means of a pneumatic lock. This is deactivated automatically after 10 s and must then be reactivated by pressing the switch if it is necessary to adjust the steering column.

The height and angle of the steering wheel are adjusted as follows:

- Press bottom of locking switch  
The steering column is unlocked
- Move steering wheel to the desired position
- Press top of locking switch  
The steering column is locked

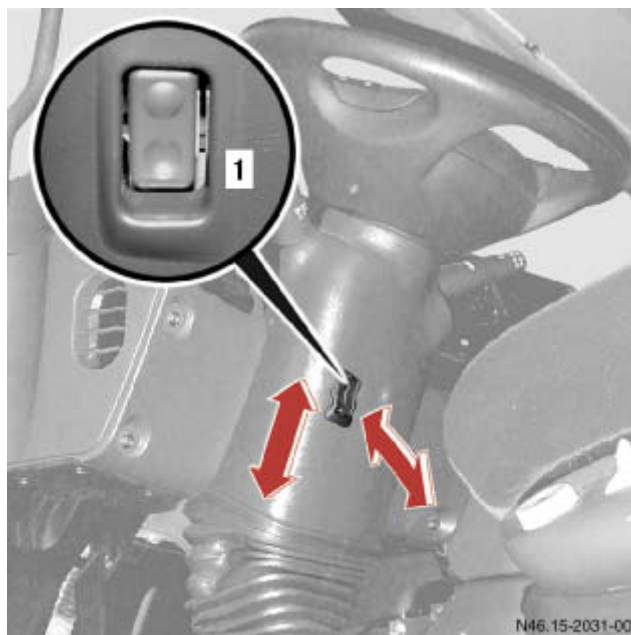

**Pneumatic lock**

1 Locking switch



#### Risk of injury

When **adjusting** the steering wheel, care must be taken to ensure that nobody is **injured** or **trapped** by **moving parts**.

#### Measures

**Stop the adjustment immediately if there is a danger of anybody being trapped.**

**The steering wheel should only be adjusted in consultation with the emergency physician.**

## Seat adjustment



*Static driver seat*



*Air-sprung suspension seat*



*Air-sprung suspension seat*

NS1 10-22155-00

A wide variety of seats are available for vehicles manufactured by DaimlerChrysler. The appearance and location of the seat controls may vary depending on the manufacturer of the seat.

Two different mechanisms are provided for adjusting the seat. One type of seat height adjustment is the static type resembling that in passenger car models. By far the most common variant is the air-sprung suspension seat.

To operate the suspension seat the ignition must be switched on and the air supply must be sufficient. Pressing the button marked **1** allows the seat to be continuously lowered or raised. Pressing the button upwards raises the level of the seat. The seat can be lowered by pressing the button downwards.

On the air-sprung suspension seats, the seat level can also be changed using the "express lowering" button marked **2**. Pressing the button once moves the seat all the way down. If the button is pressed again, the seat is raised again to the stored height.

**1** Seat height



**Press up:**

- Raise

**Press down:**

- Lower

**2** Express lowering



**Press once:**

- Seat is lowered all the way

**Press again:**

- Seat is raised to the stored height!

**Only on suspension seats!**

## Seat adjustment

### Example of driver seat



NR1-10-2256-00

#### **Grammer driver seat**

- 1 Seat cushion length adjustment
- 2 Seat inclination adjustment
- 3 Fore/aft adjustment
- 4 Express lowering
- 5 Damper adjustment
- 6 Height adjustment
- 7 Pneumatic lumbar support
- 8 Pneumatic lateral contour support
- 9 Backrest adjustment
- 10 Seat heater
- 11 Integral 3-point seat belt

- "Brandschutz" (Fire Protection) - Deutsche Feuerwehr-Zeitung (German Fire Service News), Issue 3, 1998
- Dr. Rainer Zinser of the Oberschwabenklinik Hospital, Ravensburg
- "Sicherheit von Nutzfahrzeugen" (Safety of Commercial Vehicles) - 4th DEKRA/VDI Symposium, October 2004, Neumünster

Assistance in carrying out the rescue exercises and taking the photographs was rendered by

- Ludwigshafen Fire Brigade
- Ravensburg Fire Brigade
- Niebüll Fire Brigade
- Nortorf Fire Brigade
- Stuttgart Fire Brigade/Degerloch-Hoffeld Voluntary Fire Department
- Commercial Vehicle Accident Research at DaimlerChrysler AG

## Index

<b>A</b>		<b>G</b>	
Actros 1 . . . . .	8	GGVS vehicles (hazardous goods vehicles) . . . . .	18
Actros 2 . . . . .	9	<b>I</b>	
Air bellows . . . . .	38	Initial opening . . . . .	27
Air intake . . . . .	34, 35	Integral rear end . . . . .	15, 16
Air suspension . . . . .	38	<b>R</b>	
Airbag		Rear window . . . . .	32
Function . . . . .	59	Relief cut . . . . .	51
Atego 1 . . . . .	11	Rescue of the casualty . . . . .	27, 29
Axor 1 . . . . .	10	Rescue opening . . . . .	27, 28
<b>B</b>		Roof hatch . . . . .	31
Battery . . . . .	14, 15, 16, 17	<b>S</b>	
<b>C</b>		Securing traffic . . . . .	33
Cab dimensions . . . . .	6	<b>T</b>	
<b>E</b>		Telescopic rescue ram . . . . .	53
EMERGENCY OFF switch . . . . .	19, 58	Treatment opening . . . . .	27, 28
Emergency tensioning retractor . . . . .	60	<b>W</b>	
<b>F</b>		Windows . . . . .	45
Fire protection . . . . .	33	Work platform . . . . .	43
Frame air suspension . . . . .	40		
Fuel line . . . . .	36		

