

**FIREFIGHTER EXPOSURE TO SMOKE PARTICULATES**  
(DHS AFG Grant #EMW-2007-FP-02093)

**Final Report**

Project Number: 08CA31673  
File Number: IN 15941

April 1, 2010

Prepared by:

Thomas Fabian, Ph.D., Jacob L. Borgerson, Ph.D, Stephen I. Kerber, M.S.,  
Pravinray D. Gandhi, Ph.D., P.E.  
Underwriters Laboratories Inc.

C. Stuart Baxter, Ph.D., Clara Sue Ross, M.D., J.D., James E. Lockey M.D., M.S.  
University of Cincinnati

James M. Dalton, M.Arch.  
Chicago Fire Department

Underwriters Laboratories Inc. (UL) its trustees, employees, sponsors, and contractors, make no warranties, express or implied, nor assume and expressly disclaim any legal liability or responsibility to any person for any loss or damage arising out of or in connection with the interpretation, application, or use of or inability to use, any information, data, apparatus, product, or processes disclosed in this Report. This Report cannot be modified or reproduced, in part, without the prior written permission of Underwriters Laboratories Inc.

Copyright © 2010 Underwriters Laboratories Inc.

An independent organization working for a safer world with integrity, precision and knowledge.



## **EXECUTIVE SUMMARY**

### **INTRODUCTION**

The potential for firefighters to experience acute and/or chronic respiratory health effects related to exposures during firefighting activities has long been recognized. Specific exposures of concern for firefighters, because of their potential respiratory toxicity, include: (1) asphyxiants (such as carbon monoxide, carbon dioxide and hydrogen sulfide), (2) irritants (such as ammonia, hydrogen chloride, particulates, nitrogen oxides, phenol and sulfur dioxide), (3) allergens, and (4) carcinogens (such as asbestos, benzene, styrene, polycyclic aromatic hydrocarbons and certain heavy metals). An additional cardiovascular risk factor that is receiving increasing attention is exposure to respirable particles in the ultrafine range (particles less than 0.1 micron in diameter), which have been detected in smoke. Exposure to these gaseous and particulate agents has been linked to acute and chronic effects resulting in increased fire fighter mortality and morbidity (higher risk of specific cancers and cardiovascular disease).

Currently gaps exist in the knowledge concerning the size distribution of smoke particles generated in fires and the nature of the chemicals absorbed on the particles' surfaces. Some gaseous effluents may also condense on protective equipment and exposed skin, leaving an oily residue or film. These chemicals can pose a significant threat to firefighter health directly (via the skin and eyes, or by inhalation) or following dermal absorption. This fire research study fills gaps identified in previous studies on fire fighters' exposure to combustion products. The study focuses on gaseous effluents and smoke particulates generated during residential structure and automobile fires and subsequent contact exposure resulting from residual contamination of personal protective equipment.

The information developed from this research will provide a valuable background for interpreting fire hazards and can be used by: (a) the medical community for advancing their understanding of the epidemiological effects of smoke exposure; (b) first responders for developing situational assessment guidelines for self-contained breathing apparatus (SCBA) usage, personal protection equipment cleaning regimen and identifying the importance of personal hygiene following fire effluent exposure; (c) organizations such as NIOSH and NFPA for developing new test method standards and performance criteria for respirators used by first responders and the care and maintenance of personal protection equipment.

### **METHODOLOGY**

This study investigated and analyzed the combustion gases and particulates generated from three scales of fires: residential structure and automobile fires, simulated real-scale fire tests, and material based small-scale fire tests.

Material-level tests were conducted to investigate the combustion of forty-three commonly used residential building construction materials, residential room contents and furnishings, and automobile components under consistent, well-controlled radiant heating conditions. In these tests, material based combustion properties including weight loss rate, heat and smoke release rates, smoke particle size and count distribution, and effluent gas and smoke composition were characterized for a variety of natural, synthetic, and multi-component materials under flaming

conditions. The results from these tests were used to assess the smoke contribution of individual materials.

Nine real-scale fire tests representing individual room fires, an attic fire, deck and automobile fires were conducted at UL's large-scale fire test laboratory to collect and analyze the gas effluents, smoke particulates, and condensed residues produced during fire growth, suppression and overhaul under controlled, reproducible laboratory conditions. During overhaul, firefighter personal atmospheres were sampled and analyzed for gases and smoke particles. Smoke particle analysis included mass and size distributions, and inorganic elemental composition. These tests also served as a platform for developing and refining the condensed residue sampling techniques for field usage.

Over a period of four months Chicago Fire Department designated personnel conducted personal gas monitoring and collected personal aerosol smoke samples at residential fires (knock-down, ventilation and overhaul). Replaceable personal protective components (gloves and hoods) used by the firefighters during this time period were analyzed to identify the chemical composition of accumulated smoke residue.

Collected data was forwarded to University of Cincinnati College of Medicine to assess the potential adverse health effects of the observed gaseous effluents and smoke particles on fire service personnel.

### **KEY FINDINGS**

The key findings of the research were as follows:

#### **General**

- Concentrations of combustion products were found to vary tremendously from fire to fire depending upon the size, the chemistry of materials involved, and the ventilation conditions of the fire.

#### **Material-Scale Tests**

- The type and quantity of combustion products (smoke particles and gases) generated depended on the chemistry and physical form of the materials being burned.
- Synthetic materials produced more smoke than natural materials.
  - The most prolific smoke production was observed for styrene based materials commonly found in residential households and automobiles. These materials may be used in commodity form (e.g. disposable plastic glasses and dishes), expanded form for insulation, impact modified form such as HIPS (e.g. appliances and electronics housing), copolymerized with other plastics such as ABS (e.g. toys), or copolymerized with elastomers such as styrene-butadiene rubber (e.g. tires).
  - Vinyl polymers also produced considerable amounts of smoke. Again these materials are used in commodity form (e.g. PVC pipe) or plasticized form (e.g. wiring, siding, resin chairs and tables).
  - As the fraction of synthetic compound was increased in a wood product (either in the form of adhesive or mixture such as for wood-plastic composites), smoke production increased.

## Firefighter Exposure to Smoke Particulates

- Average particle sizes ranged from 0.04 to 0.15 microns with wood and insulation generating the smallest particles.
- For a given particle size, synthetic materials will generate approximately 12.5X more particles per mass of consumed material than wood based materials.
- Combustion of the materials generated asphyxiants, irritants, and airborne carcinogenic species that could be potentially debilitating. The combination and concentrations of gases produced depended on the base chemistry of the material:
  - All of the materials formed water, carbon dioxide and carbon monoxide.
  - Styrene based materials formed benzene, phenols, and styrene.
  - Vinyl compounds formed acid gases (HCl and HCN) and benzene.
  - Wood based products formed formaldehyde, formic acid, HCN, and phenols.
  - Roofing materials formed sulfur gas compounds such as sulfur dioxide and hydrogen sulfide.

### Large-Scale Tests

- The same asphyxiants, irritants, and airborne carcinogenic species were observed as in material-level tests supporting the premise that gases generated in large-complex fires arise from individual component material contributions.
- Ventilation was found to have an inverse relationship with smoke and gas production such that considerably higher levels of smoke particulates and gases were observed in contained fires than uncontained fires, and the smoke and gas levels were greater inside of contained structures than outside.
  - Recommended exposure levels (IDLH, STEL, TWA) were exceeded during fire growth and overhaul stages for various agents (carbon monoxide, benzene, formaldehyde, hydrogen cyanide) and arsenic.
  - Smoke and gas levels were quickly reduced by suppression activity however they remained an order of magnitude greater than background levels during overhaul.
  - 99+ % of smoke particles collected during overhaul were less than 1 micron in diameter. Of these 97+ % were too small to be visible by the naked eye suggesting that “clean” air was not really that clean.
- While not the focus of this research, it should be noted that the ion alarm activated sooner than the photoelectric alarm in every room fire scenario (living rooms, bedroom, kitchen). This is consistent with results reported in the Smoke Characterization Report for model flaming fire tests conducted in the smoke alarm fire test room. Carbon monoxide alarm activation lagged behind both ion and photoelectric alarms, furthermore.

### Field Events & Controlled Field Tests

- Concentrations of certain toxic gases were monitored at field events during the course of normal firefighter duties. These results were analyzed to determine:
  - Average gas concentrations and exposures calculated for the field events, which may be useful for estimating total exposure from repeated exposures during a firefighter’s career.
  - Potential gas concentration and exposures calculated for the field events, which may be useful for planning firefighter preparedness.
  - Gas exposures in excess of NIOSH IDLH, STEL, and OSHA TWA. These were repeatedly observed at the monitored field events. Carbon monoxide concentrations most often exceeded recommended exposure limits; however instances were observed where

- other gases other than carbon monoxide exceeded recommended exposure limits yet carbon monoxide did not.
- Collected smoke particulates contained multiple heavy metals including arsenic, cobalt, chromium, lead, and phosphorous.
    - The NIOSH STEL concentration for arsenic was exceeded at one fire and possibly at a second. Gas monitors would not provide warning for arsenic exposure.
  - Chemical composition of the smoke deposited and soot accumulated on firefighter gloves and hoods was virtually the same except concentrations on the gloves were 100X greater than the hoods.
    - Deposits contained lead, mercury, phthalates and PAHs.
  - Carbon monoxide monitoring may provide a first line of gas exposure defense strategy but does not provide warning for fires in which carbon monoxide does not exceed recommended limits but other gases and chemicals do.
  - The OP-FTIR was difficult to successfully implement in the field and even for the controlled field events in passive mode.
    - While the OP-FTIR could be set-up in less than 2 minutes, it typically took as long as 5 to 10 minutes to start data collection. This time frame is too long when compared to the aggressive time frames of fire suppression.
    - Poor thermal contrast led to insufficient signal-to-noise ratios.

### Health Implications

- Multiple asphyxiants (e.g. carbon monoxide, carbon dioxide and hydrogen sulfide), irritants (e.g. ammonia, hydrogen chloride, nitrogen oxides, phenol and sulfur dioxide), allergens (e.g. isocyanates), and chemicals carcinogenic for various tissues (e.g. benzene, chromium, formaldehyde and polycyclic aromatic hydrocarbons) were found in smoke during both suppression and overhaul phases. Carcinogenic chemicals may act topically, following inhalation, or following dermal absorption, including from contaminated gear.
  - Concentrations of several of these toxicants exceeded OSHA regulatory exposure limits and/or recommended exposure limits from NIOSH or ACGIH.
  - Exposures to specific toxicants can produce acute respiratory effects that may result in chronic respiratory disease.
- High levels of ultrafine particles (relative to background levels) were found during both suppression and overhaul phases.
  - Exposure to particulate matter has been found to show a positive correlation with increased cardiovascular morbidity and mortality for general population studies.
  - The high efficiency of ultrafine particle deposition deep into the lung tissue can result in release of inflammatory mediators into the circulation, causing toxic effects on internal tissues such as the heart. Airborne toxics, such as metals and polycyclic aromatic hydrocarbons, can also be carried by the particles to the pulmonary interstitium, vasculature, and potentially subsequently to other body tissues, including the cardiovascular and nervous systems and liver.
- Interactions between individual exposure agents could lead to additive or synergistic effects exacerbating adverse health effects.
- Long-term repeated exposure may accelerate cardiovascular mortality and the initiation/progression of atherosclerosis.

## **FUTURE CONSIDERATIONS**

Based upon the results of this Firefighter Exposure to Smoke Particulates investigation, the following areas were identified for further research:

1. Greater in depth analysis of the obtained results in relation to previous studies such as those of Jankovic et al on firefighter exposure<sup>1</sup>, LeMasters et al on firefighter cancer epidemiologies<sup>2</sup>, and the first responders at the World Trade Center collapse.
2. Characterization of potential fire scene exposures including: (1) asphyxiants, (2) irritants, (3) allergens, and (4) carcinogens.
3. Better definition of the potential long-term respiratory, cancer and cardiovascular health impacts of varied and complex mixes of exposures such as those identified in this report. Such information could help guide decisions on the selection and utilization of respiratory protection, especially during overhaul activities.
4. Determination of the relative contribution of respiratory and dermal absorption routes to exposure and adverse health risks of firefighters to combustion products.
5. Factors determining coronary heart disease risk among firefighters. Such studies could help elucidate the mechanistic link between ultrafine particle exposure and coronary heart disease morbidity and mortality and identify measures to decrease its impact on this population.
6. Characterization of contaminants accumulated on firefighter protective equipment and the subsequent potential for firefighter exposures to these contaminants and resulting health effects.
7. Usage and industrial hygiene practices related to firefighter protective equipment, including cleaning patterns, length of use and storage practices.

---

<sup>1</sup> Jankovic J, Jones W, Burkhard J, Noonan G. Environmental study of firefighters. *Ann Occup Hyg*; 35: 581-602 (1991).

<sup>2</sup> LeMasters GK, Genaidy AM, Succop P, Deddens J, Sobeih T, Barriera-Viruet H, Dunning K, Lockey J. Cancer risk among firefighters: a review and meta-analysis of 32 studies. *J Occup Environ Med*. Nov 48(11):1189-202 (2006).

## TABLE OF CONTENTS

|   |             |
|---|-------------|
| <b>EXECUTIVE SUMMARY</b>  | <b>ii</b>   |
| INTRODUCTION  | ii          |
| METHODOLOGY   | ii          |
| KEY FINDINGS  | iii         |
| General   | iii         |
| Material-Scale Tests  | iii         |
| Large-Scale Tests   | iv          |
| Field Events & Controlled Field Tests   | iv          |
| Health Implications   | v           |
| FUTURE CONSIDERATIONS   | v           |
| <b>TABLE OF CONTENTS</b>  | <b>vi</b>   |
| <b>TABLE OF FIGURES</b>   | <b>xi</b>   |
| <b>TABLE OF TABLES</b>  | <b>xvii</b> |
| <br>  |             |
| <b>CHAPTER 1: INTRODUCTION</b>  | <b>1-1</b>  |
| 1.0 BACKGROUND AND MOTIVATION   | 1-1         |
| 1.1 PREVIOUS RESEARCH   | 1-3         |
| 1.1.1 Research on Firefighters  | 1-3         |
| 1.1.2 Health Assessment of Firefighter Exposure Conditions                                | 1-7         |
| 1.2 PROJECT OBJECTIVES  | 1-10        |
| 1.3 TECHNICAL PLAN  | 1-11        |
| 1.4 REFERENCES  | 1-14        |
| <br>  |             |
| <b>CHAPTER 2: DESCRIPTION OF EXPERIMENTAL EQUIPMENT</b>                                   | <b>2-1</b>  |
| 2.0 INTRODUCTION  | 2-1         |
| 2.1 EXTRACTIVE FOURIER TRANSFORM INFRARED SPECTROSCOPY (FTIR)                             | 2-1         |
| 2.2 OPEN PATH FOURIER TRANSFORM INFRARED SPECTROSCOPY (OP-FTIR)                           | 2-1         |
| 2.3 WIDE RANGE PARTICLE SPECTROMETER (WPS)  | 2-2         |
| 2.4 PERSONAL GAS MONITORING SYSTEM  | 2-3         |
| 2.5 PERSONAL CASCADE IMPACTOR   | 2-4         |
| 2.6 BENCH TOP CASCADE IMPACTOR  | 2-6         |
| 2.7 INDUCTIVE COUPLED PLASMA MASS SPECTROSCOPY (ICP-MS)                                   | 2-6         |
| 2.8 GAS CHROMATOGRAPH MASS SPECTROSCOPY (GC-MS)   | 2-6         |
| 2.9 HYDRIDE GENERATION ATOMIC ABSORPTION SPECTROSCOPY (HG-AAS)                            | 2-7         |
| 2.10 HIGH PRESSURE LIQUID CHROMATOGRAPHY (HPLC)   | 2-7         |
| 2.11 SUMMARY OF EXPERIMENTAL EQUIPMENT  | 2-7         |
| <br>  |             |
| <b>CHAPTER 3: MATERIAL-LEVEL TESTS</b>  | <b>3-1</b>  |
| 3.0 SAMPLES   | 3-1         |
| 3.1 EXPERIMENTAL  | 3-1         |
| 3.1.1 Chemistry (FTIR)  | 3-1         |
| 3.1.2 Combustibility and Associated Developed Smoke and Gases under Flaming<br>Conditions | 3-1         |
| 3.2 RESULTS   | 3-6         |

|  |            |
|--|------------|
| 3.2.1 Combustibility   | 3-6        |
| 3.2.2 Developed Smoke Particles                                | 3-10       |
| 3.2.3 Effluent Gas Composition                                 | 3-14       |
| <b>CHAPTER 4: LARGE-SCALE EXPERIMENTAL TESTS</b>               | <b>4-1</b> |
| 4.0 INTRODUCTION   | 4-1        |
| 4.1 FIRE EVENTS  | 4-1        |
| 4.1.1 Living Room  | 4-2        |
| 4.1.2 Living Room – Limited Ventilation                        | 4-5        |
| 4.1.3 Bedroom  | 4-7        |
| 4.1.4 Kitchen  | 4-8        |
| 4.1.5 Attic  | 4-9        |
| 4.1.6 Wood Deck  | 4-12       |
| 4.1.7 Composite Deck   | 4-15       |
| 4.1.8 Automobile Passenger Compartment                         | 4-16       |
| 4.1.9 Automobile Engine Compartment                            | 4-18       |
| 4.2 EXPERIMENTAL   | 4-21       |
| 4.2.1 Heat and Smoke Release Rates                             | 4-21       |
| 4.2.2 Effluent Gas Composition – OP-FTIR                       | 4-21       |
| 4.2.3 Effluent Gas Composition – Extractive FTIR               | 4-21       |
| 4.2.4 Smoke Particle Analyzer                                  | 4-22       |
| 4.2.5 Smoke Particle Size Distribution                         | 4-22       |
| 4.2.6 Personal Air Sampling – Gas                              | 4-22       |
| 4.2.7 Personal Air Sampling – Smoke Particle Size Distribution | 4-22       |
| 4.2.8 Personal Air Sampling – Smoke Particle Inorganic Content | 4-22       |
| 4.2.9 Effluent Gas Composition – Area Stands                   | 4-22       |
| 4.3 RESULTS  | 4-23       |
| 4.3.1 Living Room  | 4-23       |
| 4.3.2 Living Room - Limited Ventilation                        | 4-33       |
| 4.3.3 Bedroom  | 4-44       |
| 4.3.4 Kitchen  | 4-54       |
| 4.3.5 Attic  | 4-63       |
| 4.3.6 Wood Deck  | 4-73       |
| 4.3.7 Composite Deck   | 4-83       |
| 4.3.8 Automobile Passenger Compartment                         | 4-94       |
| 4.3.9 Automobile Engine Compartment                            | 4-103      |
| 4.4 SUMMARY  | 4-113      |
| 4.4.1 Gas Composition – FTIR                                   | 4-113      |
| 4.4.2 Gas Composition – Area Stands                            | 4-120      |
| 4.4.3 Smoke Particles  | 4-123      |
| 4.4.4 Personal Air Sampling – Gas                              | 4-125      |
| 4.4.5 Personal Air Sampling – Smoke Particle Size Distribution | 4-129      |
| 4.4.6 Personal Air Sampling – Smoke Particle Inorganic Content | 4-130      |
| <b>CHAPTER 5: CONTROLLED FIELD FIRE EVENTS</b>                 | <b>5-1</b> |
| 5.0 INTRODUCTION   | 5-1        |



## Firefighter Exposure to Smoke Particulates

|  |            |
|--|------------|
| 5.1 FIRE EVENTS  | 5-1        |
| 5.1.1 Study/Small Bedroom                                      | 5-1        |
| 5.1.2 Bathroom   | 5-2        |
| 5.1.3 Kitchen  | 5-2        |
| 5.1.4 Master Bedroom   | 5-4        |
| 5.1.5 Child's Bedroom  | 5-4        |
| 5.2 EXPERIMENTAL   | 5-5        |
| 5.2.1 Personal Air Sampling – Gas                              | 5-5        |
| 5.2.2 Personal Air Sampling – Smoke Particle Size Distribution | 5-5        |
| 5.2.3 Personal Air Sampling – Smoke Particle Inorganic Content | 5-5        |
| 5.2.4 Effluent Gas Composition                                 | 5-6        |
| 5.3 RESULTS  | 5-6        |
| 5.3.1 Study/Small Bedroom and Bathroom                         | 5-6        |
| 5.3.2 Kitchen  | 5-9        |
| 5.3.3 Master bedroom   | 5-12       |
| 5.3.4 Child's bedroom  | 5-14       |
| 5.4 SUMMARY  | 5-17       |
| 5.4.1 Personal Air Sampling – Gas                              | 5-17       |
| 5.4.2 Personal Air Sampling – Smoke Particle Size Distribution | 5-17       |
| 5.4.3 Personal Air Sampling – Smoke Particle Inorganic Content | 5-18       |
| 5.4.4 Effluent Gas Composition                                 | 5-20       |
| <br>   |            |
| <b>CHAPTER 6: FIELD EVENTS</b>                                 | <b>6-1</b> |
| 6.0 INTRODUCTION   | 6-1        |
| 6.1 FIRE EVENTS  | 6-1        |
| 6.1.1 Personal Air Sampling                                    | 6-1        |
| 6.1.2 Gloves and Hoods   | 6-1        |
| 6.2 EXPERIMENTAL   | 6-4        |
| 6.2.1 Personal Air Sampling – Gas                              | 6-4        |
| 6.2.2 Personal Air Sampling – Smoke Particle Size Distribution | 6-4        |
| 6.2.3 Personal Air Sampling – Smoke Particle Inorganic Content | 6-4        |
| 6.2.4 Hood and Glove – Inorganic Content                       | 6-5        |
| 6.2.5 Hood and Glove – Mercury Content                         | 6-5        |
| 6.2.6 Hood and Glove – Organic Content                         | 6-5        |
| 6.3 RESULTS  | 6-6        |
| 6.3.1 Personal Air Sampling – Gas                              | 6-6        |
| 6.3.2 Personal Air Sampling – Smoke Particle Size Distribution | 6-11       |
| 6.3.3 Personal Air Sampling – Smoke Particle Inorganic Content | 6-12       |
| 6.3.4 Hood and Glove – Inorganic Content                       | 6-19       |
| 6.3.5 Hood and Glove – Mercury Content                         | 6-21       |
| 6.3.6 Hood and Glove – Organic Content                         | 6-23       |
| <br>   |            |
| <b>CHAPTER 7: HEALTH IMPLICATIONS</b>                          | <b>7-1</b> |
| 7.0 CHEMICAL SPECIFIC HEALTH IMPACTS                           | 7-1        |
| 7.1 RESPIRATORY  | 7-1        |
| 7.1 CARDIOVASCULAR   | 7-2        |

|   |            |
|---|------------|
| 7.2 CANCER  | 7-3        |
| 7.3 OTHER   | 7-4        |
| 7.4 REFERENCES  | 7-4        |
| <b>CHAPTER 8: SUMMARY OF FINDINGS</b>                             | <b>8-1</b> |
| 8.1 OVERALL   | 8-1        |
| 8.2 MATERIAL-SCALE TESTS  | 8-1        |
| 8.3 LARGE-SCALE TESTS   | 8-2        |
| 8.4 FIELD EVENTS & CONTROLLED FIELD TESTS                         | 8-2        |
| 8.5 HEALTH IMPLICATIONS   | 8-3        |
| <b>CHAPTER 9: ACKNOWLEDGEMENTS</b>                                | <b>9-1</b> |
| <b>APPENDIX A: LITERATURE STUDY RESULTS</b>                       | <b>A-1</b> |
| A.0 PURPOSE OF THE SEARCH   | A-1        |
| A.1 SUMMARY OF THE SEARCH   | A-1        |
| A.2 TOPIC AREAS   | A-2        |
| A.3 SEARCH RESULTS  | A-3        |
| A.3.1 Problem   | A-3        |
| A.3.2 Previous Research Methodology                               | A-4        |
| A.3.3 Previous Research Results                                   | A-6        |
| A.3.4 Identified Research Focus Areas                             | A-6        |
| APPENDIX A-1: DOCUMENT LIST                                       | A-8        |
| APPENDIX A-2: REFERENCES AND SUMMARIES OF MOST RELEVANT DOCUMENTS | A-16       |
| APPENDIX A-3: TABLES FROM [AUSTIN 2001]                           | A-48       |
| APPENDIX A-4: TABLES FROM [BOLSTAD-JOHNSON 2000]                  | A-53       |
| APPENDIX A-5: TABLES AND FIGURES FROM [BRANDT-RAUF 1988]          | A-56       |
| APPENDIX A-6: TABLES FROM [BRYANT 2007]                           | A-59       |
| APPENDIX A-7: TABLES FROM [BURGESS 2001]                          | A-60       |
| APPENDIX A-8: TABLES AND FIGURES FROM [BURGESS 1977]              | A-61       |
| APPENDIX A-9: TABLES AND FIGURES FROM [GOLD 1978]                 | A-64       |
| APPENDIX A-10: TABLES AND FIGURES FROM [JANKOVIC 1991]            | A-65       |
| APPENDIX A-11: TABLES FROM [KINES 1996]                           | A-70       |
| APPENDIX A-12: TABLES AND FIGURES FROM [TREITMAN 1980]            | A-78       |
| APPENDIX A-13: TABLES FROM [LEONARD 2007]                         | A-81       |
| APPENDIX A-14: TABLES FROM [LEMASTERS 2006]                       | A-82       |
| APPENDIX A-15: TABLES AND FIGURES FROM [BATES 2007]               | A-87       |
| APPENDIX A-16: TABLES AND FIGURES FROM [URS CORPORATION 2004]     | A-89       |
| <b>APPENDIX B: LARGE-SCALE FIRE TEST DRAWINGS</b>                 | <b>B-1</b> |
| B.0 OVERVIEW  | B-1        |
| B.1 ORDER OF CAD DRAWINGS   | B-1        |
| General construction for living rooms, bedroom, kitchen           | B-2        |
| Living room – instrumentation                                     | B-3        |
| Living room – furnishings layout                                  | B-4        |

## Firefighter Exposure to Smoke Particulates

|  |      |
|--|------|
| Limited ventilation living room – instrumentation    | B-5  |
| Limited ventilation living room – furnishings layout | B-6  |
| Bedroom – instrumentation                            | B-7  |
| Bedroom – furnishings layout                         | B-8  |
| Kitchen – instrumentation                            | B-9  |
| Kitchen – furnishings layout                         | B-10 |
| General construction for attic                       | B-11 |
| Attic – instrumentation                              | B-12 |
| Attic – furnishings layout                           | B-13 |
| General construction for wood deck                   | B-14 |
| General construction for composite deck              | B-15 |
| Deck – furnishings layout                            | B-16 |
| Automobile passenger compartment – instrumentation   | B-17 |
| Automobile engine compartment – instrumentation      | B-18 |

|  |            |
|--|------------|
| <b>APPENDIX C: LARGE-SCALE FIRE TEST SAMPLES</b> | <b>C-1</b> |
| C.0 OVERVIEW                                     | C-1        |
| C.1 LIVING ROOM FIRE                             | C-1        |
| C.2 LIMITED VENTILATION LIVING ROOM FIRE         | C-3        |
| C.3 BEDROOM FIRE                                 | C-6        |
| C.4 KITCHEN FIRE                                 | C-8        |
| C.5 ATTIC FIRE                                   | C-11       |
| C.6 WOOD DECK FIRE                               | C-13       |
| C.7 COMPOSITE DECK FIRE                          | C-14       |
| C.8 AUTOMOBILE PASSENGER COMPARTMENT FIRE        | C-15       |
| C.9 AUTOMOBILE ENGINE COMPARTMENT FIRE           | C-16       |

## TABLE OF FIGURES

|   |      |
|---|------|
| Figure 2-1: Open Path FTIR components and example of active mode arrangement used for large-scale tests.  | 2-2  |
| Figure 2-2: WPS and Extractive FTIR arrangement for attic fire test.  | 2-3  |
| Figure 2-3: Personal Gas Monitoring System (MX6 Ibrid).   | 2-4  |
| Figure 2-4: Personal cascade impactor.  | 2-5  |
| Figure 2-5: IBRID gas monitor and Marple particle impactor attached to firefighter SCBA harness.  | 2-5  |
| Figure 2-6: Bench impactor.   | 2-6  |
| Figure 3-1: Test apparatus schematic for combustibility and associated developed smoke and gas measurements.  | 3-2  |
| Figure 3-2: Schematic of ASTM E 1354 cone calorimeter (reprinted from ASTM E 1354).   | 3-3  |
| Figure 3-3: ASTM E1354 Cone calorimeter sample holder   | 3-3  |
| Figure 3-4: Time to ignition for material-level test samples.   | 3-8  |
| Figure 3-5: Peak heat release rates (top) and effective heat of combustion (bottom) for material-level test samples.  | 3-9  |
| Figure 3-6: Smoke production for material-level test samples.   | 3-10 |
| Figure 3-7: Average smoke particle diameter $D_m$ for material-level test samples.  | 3-12 |
| Figure 3-8: Specific smoke particle number density $N_m$ for material-level test samples.   | 3-13 |
| Figure 3-9: Specific smoke number density versus average particle size for material-level test samples.   | 3-14 |
| Figure 3-10: Carbon dioxide and monoxide yields for material-level test samples.  | 3-16 |
| Figure 3-11: Carbon dioxide to carbon monoxide yield ratio for material-level test samples.   | 3-16 |
| Figure 4-1: Photograph of the furnished living room interior. Note the gas and particle sampling probe extending into the right side of the room at standing face level.                                      | 4-3  |
| Figure 4-2: Schematic diagram showing the instrumentation placement for the living room scenario  | 4-4  |
| Figure 4-3: Photograph of the furnished living room interior for the limited ventilation fire test. Note the thermocouple instrumented post in the center of the room.  | 4-6  |
| Figure 4-4: Photograph of the furnished bedroom interior. Note the gas and particle sampling probe extending into the right side of the room at standing face level.  | 4-8  |
| Figure 4-5: Photograph showing the furnished kitchen interior.  | 4-9  |
| Figure 4-6: Photograph of the furnished attic space interior.   | 4-10 |
| Figure 4-7: Schematic diagram showing the instrumentation placement for the attic scenario  | 4-11 |
| Figure 4-8: Photograph showing the wood deck scenario with furnishings. Note the the gas and particle sampling probe extending from the right of the sliding glass door over the deck at standing face level. | 4-13 |
| Figure 4-9: Schematic diagram showing the instrumentation placement for the deck scenario   | 4-14 |
| Figure 4-10: Photograph showing the composite deck scenario with furnishings.   | 4-15 |
| Figure 4-11: Photograph showing the automobile for the passenger compartment scenario   | 4-17 |
| Figure 4-12: Schematic diagram showing the instrumentation placement for the automobile passenger compartment scenario  | 4-17 |

|  |      |
|--|------|
| Figure 4-13: Photograph showing the automobile for the engine compartment scenario   | 4-19 |
| Figure 4-14: Schematic diagram showing the instrumentation placement for the automobile engine compartment scenario  | 4-20 |
| Figure 4-15: Automobile engine compartment fire initiation device.   | 4-21 |
| Figure 4-16: Heat release rate during the fire growth phase of the living room fire.   | 4-23 |
| Figure 4-17: Smoke release rate during the fire growth phase of the living room fire.  | 4-24 |
| Figure 4-18: Gas concentration measured by OP-FTIR for the living room fire.   | 4-25 |
| Figure 4-19: Gas concentration measured by extractive FTIR during overhaul of the living room fire.  | 4-26 |
| Figure 4-20: Smoke particle average size (top) and count density (bottom) measured with the particle analyzer during overhaul of the living room fire.                   | 4-27 |
| Figure 4-21: Smoke particle size distribution measured with the particle analyzer during overhaul of the living room fire.   | 4-28 |
| Figure 4-22: Gas concentrations measured by personal monitors during overhaul of the living room fire.   | 4-29 |
| Figure 4-23: Inorganic element concentrations measured for smoke particles collected with personal cascade impactors during overhaul of the living room fire.            | 4-31 |
| Figure 4-24: Heat release rate during the fire growth phase of the limited ventilation living room fire.   | 4-33 |
| Figure 4-25: Smoke release rate during the fire growth phase of the limited ventilation living room fire.  | 4-34 |
| Figure 4-26: Gas concentration measured by OP-FTIR for the limited ventilation living room fire.   | 4-35 |
| Figure 4-27: Gas concentration measured by extractive FTIR for the limited ventilation living room fire.   | 4-36 |
| Figure 4-28: Smoke particle average size (top) and count density (bottom) measured with the particle analyzer for the limited ventilation living room fire.              | 4-38 |
| Figure 4-29: Smoke particle size distribution measured with the particle analyzer for the limited ventilation living room.   | 4-39 |
| Figure 4-30: Gas concentrations measured by personal monitors during overhaul of the limited ventilation living room fire.   | 4-40 |
| Figure 4-31: Inorganic element concentrations measured for smoke particles collected with personal cascade impactors during of the limited ventilation living room fire. | 4-42 |
| Figure 4-32: Heat release rate during the fire growth phase of the bedroom fire.   | 4-44 |
| Figure 4-33: Smoke release rate during the fire growth phase of the bedroom fire.  | 4-45 |
| Figure 4-34: Gas concentration measured by OP-FTIR for the bedroom fire.   | 4-46 |
| Figure 4-35: Gas concentration measured by extractive FTIR during overhaul of the bedroom fire.  | 4-47 |
| Figure 4-36: Smoke particle average size (top) and count density (bottom) measured with the particle analyzer during overhaul of the bedroom fire.                       | 4-48 |
| Figure 4-37: Smoke particle size distribution measured with the particle analyzer during overhaul of the bedroom fire.   | 4-49 |
| Figure 4-38: Gas concentrations measured by personal monitors during overhaul of the bedroom fire.   | 4-50 |
| Figure 4-39: Inorganic element concentrations measured for smoke particles collected with personal cascade impactors during overhaul of the bedroom fire.                | 4-52 |

|   |      |
|---|------|
| Figure 4-40: Heat release rate during the fire growth phase of the kitchen fire.  | 4-54 |
| Figure 4-41: Smoke release rate during the fire growth phase of the kitchen fire.   | 4-55 |
| Figure 4-42: Gas concentration measured by extractive FTIR during overhaul of the kitchen fire.   | 4-56 |
| Figure 4-43: Smoke particle average size (top) and count density (bottom) measured with the particle analyzer during overhaul of the kitchen fire.          | 4-57 |
| Figure 4-44: Smoke particle size distribution measured with the particle analyzer during overhaul of the kitchen fire.                                      | 4-58 |
| Figure 4-45: Gas concentrations measured by personal monitors during overhaul of the kitchen fire.  | 4-59 |
| Figure 4-46: Inorganic element concentrations measured for smoke particles collected with personal cascade impactors during overhaul of the kitchen fire.   | 4-61 |
| Figure 4-47: Heat release rate during the fire growth phase of the attic fire.  | 4-63 |
| Figure 4-48: Smoke release rate during the fire growth phase of the attic fire.   | 4-64 |
| Figure 4-49: Gas concentration measured by OP-FTIR for the attic fire.  | 4-65 |
| Figure 4-50: Gas concentration measured by extractive FTIR for the attic fire.  | 4-66 |
| Figure 4-51: Smoke particle average size (top) and count density (bottom) measured with the particle analyzer for the attic fire.                           | 4-67 |
| Figure 4-52: Smoke particle size distribution measured with the particle analyzer for the attic fire.   | 4-68 |
| Figure 4-53: Gas concentrations measured by personal monitors during overhaul of the attic fire.  | 4-69 |
| Figure 4-54: Inorganic element concentrations measured for smoke particles collected with personal cascade impactors during overhaul of the attic fire.     | 4-71 |
| Figure 4-55: Heat release rate during the fire growth phase of the wood deck fire.  | 4-73 |
| Figure 4-56: Smoke release rate during the fire growth phase of the wood deck fire.   | 4-74 |
| Figure 4-57: Gas concentration measured by OP-FTIR for the wood deck fire.  | 4-75 |
| Figure 4-58: Gas concentration measured by extractive FTIR during overhaul of the wood deck fire.   | 4-76 |
| Figure 4-59: Smoke particle average size (top) and count density (bottom) measured with the particle analyzer during overhaul of the wood deck fire.        | 4-77 |
| Figure 4-60: Smoke particle size distribution measured with the particle analyzer during overhaul of the wood deck fire.                                    | 4-78 |
| Figure 4-61: Gas concentrations measured by personal monitors during overhaul of the wood deck fire.  | 4-79 |
| Figure 4-62: Inorganic element concentrations measured for smoke particles collected with personal cascade impactors during overhaul of the wood deck fire. | 4-81 |
| Figure 4-63: Heat release rate during the fire growth phase of the composite deck fire.   | 4-83 |
| Figure 4-64: Smoke release rate during the fire growth phase of the composite deck fire.  | 4-84 |
| Figure 4-65: Gas concentration measured by OP-FTIR for the composite deck fire.   | 4-85 |
| Figure 4-66: Gas concentration measured by extractive FTIR during overhaul of the composite deck fire.  | 4-86 |
| Figure 4-67: Smoke particle average size (top) and count density (bottom) measured with the particle analyzer during overhaul of the composite deck fire.   | 4-88 |
| Figure 4-68: Smoke particle size distribution measured with the particle analyzer during overhaul of the composite deck fire.                               | 4-89 |

|   |       |
|---|-------|
| Figure 4-69: Gas concentrations measured by personal monitors during overhaul of the composite deck fire.   | 4-90  |
| Figure 4-70: Inorganic element concentrations measured for smoke particles collected with personal cascade impactors during overhaul of the composite deck fire.  | 4-92  |
| Figure 4-71: Scintillating shrapnel resulting from air bag deployment during the passenger compartment fire.  | 4-94  |
| Figure 4-72: Heat (top) and smoke release rate (bottom) during the fire growth phase of the passenger compartment fire.   | 4-95  |
| Figure 4-73: Gas concentration measured by OP-FTIR for the passenger compartment fire.  | 4-96  |
| Figure 4-74: Gas concentration measured by extractive FTIR during overhaul of the passenger compartment fire.   | 4-97  |
| Figure 4-75: Smoke particle average size (top) and count density (bottom) measured with the particle analyzer during overhaul of the passenger compartment fire.  | 4-99  |
| Figure 4-76: Smoke particle size distribution measured with the particle analyzer during overhaul of the passenger compartment fire.  | 4-100 |
| Figure 4-77: Gas concentrations measured by personal monitors during overhaul of the passenger compartment fire.  | 4-101 |
| Figure 4-78: Heat release rate during the fire growth phase of the engine compartment fire.   | 4-103 |
| Figure 4-79: Smoke release rate during the fire growth phase of the engine compartment fire.  | 4-104 |
| Figure 4-80: Gas concentration measured by OP-FTIR for the engine compartment fire.   | 4-105 |
| Figure 4-81: Gas concentration measured by extractive FTIR for the engine compartment fire.   | 4-106 |
| Figure 4-82: Smoke particle average size (top) and count density (bottom) measured with the particle analyzer for the engine compartment fire. Data gap corresponds to suppression at the sampling probe. | 4-107 |
| Figure 4-83: Smoke particle size distribution measured with the particle analyzer for the engine compartment fire.  | 4-108 |
| Figure 4-84: Gas concentrations measured by personal monitors during overhaul of the engine compartment fire.   | 4-109 |
| Figure 4-85: Inorganic element concentrations measured for smoke particles collected with personal cascade impactors during overhaul of the engine compartment fire.                                      | 4-111 |
| Figure 4-86: Peak gas concentrations measured with OP-FTIR for the large-scale fires.   | 4-115 |
| Figure 4-87: Total gas exposure measured with OP-FTIR for the large-scale fires.  | 4-116 |
| Figure 4-88: Peak gas concentrations measured with extractive FTIR during overhaul of the large-scale fires.  | 4-117 |
| Figure 4-89: Total gas exposure measured with extractive FTIR during overhaul of the large-scale fires.   | 4-118 |
| Figure 4-90: Mass distribution of smoke particles collected with the bench-top cascade impactor during the fire growth phase for the large-scale fires.   | 4-125 |
| Figure 4-91: Peak gas concentrations measured with personal monitors during overhaul of the large-scale fires.  | 4-127 |
| Figure 4-92: Total gas exposure measured with personal monitors during overhaul of the large-scale fires.   | 4-128 |

|   |       |
|---|-------|
| Figure 4-93: Smoke particle size distribution for personal impactors used in the large-scale fires.   | 4-129 |
| Figure 4-94: Variation in mass distribution of smoke particles collected with personal impactors during overhaul of the large-scale fires.  | 4-130 |
| Figure 4-95: Frequency of large-scale fires in which inorganic elements were detected in personal impactor collected smoke particles.   | 4-131 |
| Figure 4-96: Frequency of large-scale fire personal impactor collected smoke particle samples in which inorganic elements were detected.  | 4-133 |
| Figure 4-97: ICP elemental analysis of personal impactor collected smoke particles from large-scale fires.  | 4-134 |
| Figure 5-1: Farmhouse that was utilized to conduct controlled field fire events.  | 5-1   |
| Figure 5-2: Study/Small bedroom prior to controlled field fire event.   | 5-2   |
| Figure 5-3: Kitchen prior to controlled field fire event. Kitchen ignition source is depicted in the bottom figure.   | 5-3   |
| Figure 5-4: Master bedroom prior to controlled field fire event.  | 5-4   |
| Figure 5-5: Child's bedroom prior to controlled field fire event.   | 5-5   |
| Figure 5-6: Study/Small bedroom after controlled field fire event.  | 5-6   |
| Figure 5-7: Gas concentrations measured by personal monitors for the study/small bedroom fire followed by the bathroom fire.  | 5-7   |
| Figure 5-8: Inorganic element concentrations measured for smoke particles collected using personal cascade impactor for the study/small bedroom fire followed by the bathroom fire. | 5-8   |
| Figure 5-9: Relative gas concentrations determined by OP-FTIR for the study/small bedroom fire.   | 5-8   |
| Figure 5-10: Kitchen after the controlled field fire event.   | 5-9   |
| Figure 5-11: Gas concentrations measured by personal monitors for the kitchen fire.   | 5-10  |
| Figure 5-12: Inorganic element concentrations measured for smoke particles collected using personal cascade impactor for the kitchen fire.  | 5-11  |
| Figure 5-13: Relative gas concentrations determined by OP-FTIR for the kitchen fire.  | 5-11  |
| Figure 5-14: Inorganic element concentrations measured for smoke particles collected using personal cascade impactor for the master bedroom fire.                                   | 5-12  |
| Figure 5-15: Gas concentrations measured by personal monitors for the master bedroom fire.  | 5-13  |
| Figure 5-16: Child's bedroom after the controlled field fire event.   | 5-14  |
| Figure 5-17: Gas concentrations measured by personal monitors for the child's bedroom fire.   | 5-15  |
| Figure 5-18: Inorganic element concentrations measured for smoke particles collected using personal cascade impactor for the child's bedroom fire.                                  | 5-16  |
| Figure 5-19: Relative gas concentrations determined by OP-FTIR for the child's bedroom fire.  | 5-16  |
| Figure 5-20: Smoke particle size distribution for personal impactors used in the controlled field fire events.  | 5-18  |
| Figure 5-21: ICP elemental analysis of smoke particles from controlled field event fires.   | 5-19  |
| Figure 6-1: Examples of personal gas monitor data. Note how the carbon monoxide and sulfur dioxide sensors saturated during the fire presented in the top figure.                   | 6-7   |
| Figure 6-2: Peak gas concentrations measured at fire events.  | 6-9   |



## Firefighter Exposure to Smoke Particulates

|  |      |
|--|------|
| Figure 6-3: Total gas exposure measured at fire events.  | 6-10 |
| Figure 6-4: Distribution of flow corrected accumulated smoke particles in personal cascade impactors.                            | 6-12 |
| Figure 6-5: Examples of inorganic element concentrations measured for two personal cascade impactor smoke particle sets.         | 6-13 |
| Figure 6-6: Number of fires in which inorganic elements were found in smoke particles collected with personal cascade impactors. | 6-14 |
| Figure 6-7: Number of smoke particle samples in which inorganic elements were found as a function of collected particle size.    | 6-15 |
| Figure 6-8: Inorganic element concentration distributions measured for different size smoke particles.                           | 6-16 |
| Figure 6-9: Inorganic element concentration measured in exposed and unexposed firefighter gloves.                                | 6-20 |
| Figure 6-10: Inorganic element concentration measured in exposed and unexposed firefighter hoods.                                | 6-21 |
| Figure 6-11: Mercury content in exposed and unexposed firefighter gloves.  | 6-22 |
| Figure 6-12: Mercury content in exposed and unexposed firefighter hoods.   | 6-22 |
| Figure 6-13: PAH and other organic compound content of unexposed and exposed firefighter gloves.                                 | 6-23 |
| Figure 6-14: PAH and other organic compound content of unexposed and exposed firefighter hoods.                                  | 6-24 |

## TABLE OF TABLES

|   |      |
|---|------|
| Table 1-1: Report Organization  | 1-13 |
| Table 2-1: Sample collection and analytical techniques used for fire tests.   | 2-8  |
| Table 3-1: List of evaluated material-level test samples.   | 3-1  |
| Table 3-2: ASTM E1354 combustibility data for material-level samples.   | 3-7  |
| Table 3-3: Smoke particle data for material-level test samples.   | 3-11 |
| Table 3-4: Effluent gases detected in combustion of material-level test samples.  | 3-15 |
| Table 4-1: Summary of OP-FTIR gas concentration data for the living room fire.  | 4-27 |
| Table 4-2: Summary of extractive FTIR gas concentration data for overhaul of the living room fire.  | 4-28 |
| Table 4-3: Summary of personal gas monitor data for overhaul of the living room fire.   | 4-32 |
| Table 4-4: Mass distribution of smoke particles collected on personal cascade impactors during overhaul of the living room fire.                                    | 4-32 |
| Table 4-5: Gas concentrations collected with area sampling stand during overhaul of the living room fire.   | 4-34 |
| Table 4-6: Summary of OP-FTIR gas concentration data for the limited ventilation living room fire.  | 4-37 |
| Table 4-7: Summary of extractive FTIR gas concentration data for the limited ventilation living room fire.  | 4-39 |
| Table 4-8: Smoke particle size distribution measured by cascade impactor during the incipient fire growth phase of the limited ventilation living room fire.        | 4-41 |
| Table 4-9: Summary of personal gas monitor data for overhaul of the limited ventilation living room fire.   | 4-43 |
| Table 4-10: Smoke particle size distribution measured with the bench-top cascade impactor during the fire growth phase of the limited ventilation living room fire. | 4-43 |
| Table 4-11: Gas concentrations collected with area sampling stand for the limited ventilation living room fire.   | 4-45 |
| Table 4-12: Summary of OP-FTIR gas concentration data for the bedroom fire.   | 4-48 |
| Table 4-13: Summary of extractive FTIR gas concentration data for overhaul of the bedroom fire.   | 4-49 |
| Table 4-14: Summary of personal gas monitor data for overhaul of the bedroom fire.  | 4-53 |
| Table 4-15: Mass distribution of smoke particles collected on personal cascade impactors during overhaul of the bedroom fire.                                       | 4-53 |
| Table 4-16: Gas concentrations collected with area sampling stand during overhaul of the bedroom fire.  | 4-55 |
| Table 4-17: Summary of extractive FTIR gas concentration data for overhaul of the kitchen fire.   | 4-58 |
| Table 4-18: Smoke particle size distribution measured with the bench-top cascade impactor during the fire growth phase of the kitchen fire.                         | 4-60 |
| Table 4-19: Summary of personal gas monitor data for overhaul of the kitchen fire.  | 4-62 |
| Table 4-20: Mass distribution of smoke particles collected on personal cascade impactors during overhaul of the kitchen fire.                                       | 4-62 |
| Table 4-21: Gas concentrations collected with area sampling stand during overhaul of the kitchen fire.  | 4-64 |
| Table 4-22: Summary of OP-FTIR gas concentration data for the attic fire.   | 4-67 |
| Table 4-23: Summary of extractive FTIR gas concentration data for the attic fire.   | 4-68 |

|  |       |
|--|-------|
| Table 4-24: Smoke particle size distribution measured with the bench-top cascade impactor during the initial fire growth phase of the attic fire.      | 4-70  |
| Table 4-25: Summary of personal gas monitor data for overhaul of the attic fire.   | 4-72  |
| Table 4-26: Mass distribution of smoke particles collected on personal cascade impactors during overhaul of the attic fire.                            | 4-72  |
| Table 4-27: Gas concentrations collected with area sampling stand during the attic fire.   | 4-74  |
| Table 4-28: Summary of OP-FTIR gas concentration data for the wood deck fire.  | 4-77  |
| Table 4-29: Summary of extractive FTIR gas concentration data for overhaul of the wood deck fire.  | 4-78  |
| Table 4-30: Smoke particle size distribution measured with the bench-top cascade impactor during the fire growth phase of the wood deck fire.          | 4-80  |
| Table 4-31: Summary of personal gas monitor data for overhaul of the wood deck fire.   | 4-82  |
| Table 4-32: Mass distribution of smoke particles collected on personal cascade impactors during overhaul of the wood deck fire.                        | 4-82  |
| Table 4-33: Gas concentrations collected with area sampling stand for the wood deck fire.  | 4-84  |
| Table 4-34: Summary of OP-FTIR gas concentration data for the composite deck fire.   | 4-87  |
| Table 4-35: Summary of extractive FTIR gas concentration data for overhaul of the composite deck fire.   | 4-88  |
| Table 4-36: Smoke particle size distribution measured with the bench-top cascade impactor during the fire growth phase of the composite deck fire.     | 4-91  |
| Table 4-37: Summary of personal gas monitor data for overhaul of the composite deck fire.  | 4-93  |
| Table 4-38: Mass distribution of smoke particles collected on personal cascade impactors during overhaul of the composite deck fire.                   | 4-93  |
| Table 4-39: Gas concentrations collected with area sampling stand during overhaul of the composite deck fire.  | 4-95  |
| Table 4-40: Summary of OP-FTIR gas concentration data for the passenger compartment fire.  | 4-99  |
| Table 4-41: Summary of extractive FTIR gas concentration data for overhaul of the passenger compartment fire.  | 4-100 |
| Table 4-42: Summary of personal gas monitor data for overhaul of the passenger compartment fire.   | 4-104 |
| Table 4-43: Gas concentrations collected with area sampling stand during the passenger compartment fire.   | 4-104 |
| Table 4-44: Summary of OP-FTIR gas concentration data for the engine compartment fire.   | 4-107 |
| Table 4-45: Summary of extractive FTIR gas concentration data for the engine compartment fire.   | 4-108 |
| Table 4-46: Smoke particle size distribution measured with the bench-top cascade impactor during the fire growth phase of the engine compartment fire. | 4-110 |
| Table 4-47: Summary of personal gas monitor data for overhaul of the engine compartment fire.  | 4-112 |
| Table 4-48: Mass distribution of smoke particles collected on personal cascade impactors during overhaul of the engine compartment fire.               | 4-112 |
| Table 4-49: Gas concentrations collected with area sampling stands for the engine compartment fire.  | 4-114 |

|   |       |
|---|-------|
| Table 4-50: Effluent gases other than water and carbon dioxide detected by OP-FTIR and extractive FTIR.   | 4-116 |
| Table 4-51: Descriptive statistics for peak gas concentrations measured with OP-FTIR for the large-scale fires.   | 4-117 |
| Table 4-52: Descriptive statistics for total gas exposure measured with OP-FTIR for the large-scale fires.  | 4-118 |
| Table 4-53: Descriptive statistics for peak gas concentrations measured with extractive FTIR during overhaul of the large-scale fires.  | 4-119 |
| Table 4-54: Descriptive statistics for total gas exposure measured with extractive FTIR during overhaul of the large-scale fires.   | 4-120 |
| Table 4-55: Large-scale fire scenarios in which FTIR measured gas concentrations exceeded various recommended exposure limits.  | 4-122 |
| Table 4-56: Gas and airborne vapor concentrations measured with area stands for the large-scale fires.  | 4-124 |
| Table 4-57: Large-scale fires in which gases and airborne vapors measured with area stands exceeded recommended exposure limits.  | 4-125 |
| Table 4-58: Smoke particle number density and size distribution during overhaul of the large-scale fires.   | 4-126 |
| Table 4-59: Smoke particle number density and size distribution for later stages of overhaul of the large-scale fires.  | 4-126 |
| Table 4-60: Descriptive statistics for peak gas concentrations measured with personal monitors during overhaul of the large-scale fires.  | 4-128 |
| Table 4-61: Descriptive statistics for total gas exposure measured with personal monitors during overhaul of the large-scale fires.   | 4-128 |
| Table 4-62: Descriptive statistics for peak gas concentrations measured with personal monitors during overhaul of the large-scale fires.  | 4-129 |
| Table 4-63: Descriptive statistics for total gas exposure measured with personal monitors during overhaul of the large-scale fires.   | 4-130 |
| Table 4-64: Number of large-scale fire scenarios in which gas concentrations measured with personal monitors during overhaul exceeded various recommended exposure limits.      | 4-131 |
| Table 4-65: Descriptive statistics for mass distribution of smoke particles collected with personal impactors during overhaul of the large-scale fires.                         | 4-132 |
| Table 4-66: Large-scale fires in which inorganic elements were detected in personal impactor collected smoke particles.   | 4-134 |
| Table 4-67: Descriptive statistics for inorganic element concentrations measured in different sized smoke particles collected with personal impactors at large-scale fires.     | 4-137 |
| Table 4-68: Number of large-scale fires in which inorganic element concentrations for personal impactor collected smoke particles exceeded various recommended exposure limits. | 4-139 |
| Table 5-1: Number of controlled field fires in which gas concentrations exceeded various recommended exposure limits.   | 5-17  |
| Table 5-2: Number of controlled field fires in which inorganic element concentrations exceeded various recommended exposure limits.   | 5-20  |
| Table 5-3: Effluent gases observed by OP-FTIR.  | 5-20  |
| Table 6-1: Description of fire events responded to and measurements employed.   | 6-2   |

## Firefighter Exposure to Smoke Particulates

|   |      |
|---|------|
| Table 6-2: Identification of fire events at which gloves and hoods were exposed.                                    | 6-4  |
| Table 6-3: Descriptive statistics for peak gas concentrations measured at fire events.                              | 6-8  |
| Table 6-4: Descriptive statistics for total gas exposure measured at fire events.                                   | 6-8  |
| Table 6-5: Descriptive statistics for peak gas concentrations measured at fire events.                              | 6-9  |
| Table 6-6: Descriptive statistics for total gas exposure measured at fire events.                                   | 6-10 |
| Table 6-7: Number of fires in which gas concentrations exceeded various recommended exposure limits.                | 6-11 |
| Table 6-8: Descriptive statistics for flow corrected accumulated smoke particles in personal cascade impactors.     | 6-12 |
| Table 6-9: Descriptive statistics for inorganic element concentrations measured in different sized smoke particles. | 6-17 |
| Table 6-10: Number of fires in which inorganic element concentrations exceeded various recommended exposure limits. | 6-19 |
| Table 6-11: Exposure limits and environmental classifications for PAH and other organic compounds.                  | 6-25 |



## CHAPTER 1: INTRODUCTION

This fire research study fills gaps identified in previous studies on firefighters' exposure to combustion products. The study focuses on gas effluent, airborne chemicals and smoke particulates generated during residential structure and automobile fires and subsequent contact exposure resulting from residual contamination of personal protective equipment. Exposure to gases, volatile chemicals and particulates has been linked to acute and chronic effects that result in increased firefighter mortality and morbidity due to higher risks of specific cancers and cardiovascular disease.

Currently gaps exist in the knowledge of the size distribution of smoke particles generated in fires and the chemicals absorbed on the particles' surfaces. Some gases and airborne chemicals may also condense on the protective equipment and exposed skin leaving a surface residue. These chemicals can pose a significant threat to firefighter health directly (via the skin and eyes, or by inhalation) or following dermal absorption. This study documents the composition of the gases, volatile chemicals and particulates generated from fires involving residential construction and contents.

This study investigated and analyzed the products of combustion, including gases and particulates, generated from three scales of fire: residential structure and automobile fires; simulated real-scale fire tests; and material based small-scale fire tests. Working in collaboration with University of Cincinnati College of Medicine, the data was assessed for potential adverse health effects of the combustion products on fire service personnel.

The information developed from this research will provide a valuable background for interpreting fire hazards and can be used by: (a) the medical community for advancing their understanding of the epidemiological effects of smoke exposure; (b) first responders for developing situational assessment guidelines for self-contained breathing apparatus (SCBA) usage, personal protection equipment cleaning regimen and identifying the importance of personal hygiene following fire effluent exposure; (c) organizations such as NIOSH and NFPA for developing new test method standards and performance criteria for respirators used by first responders and the care and maintenance of personal protection equipment.

### 1.0 BACKGROUND AND MOTIVATION

NFPA estimates that from 2003-2006 firefighters responded annually to an average of 378,600 residential fires<sup>1</sup>; and in 2006 there were more than 23,000 firefighter exposures to hazardous conditions (including chemicals, fumes and particulates)<sup>2</sup>. Firefighters' exposures include not only gases, but also smoke particles that may be inhaled or contaminate the skin or clothing, with subsequent absorption of adsorbed chemicals through the skin at the fire scene. Later exposure from particulates contaminating firefighting garments may also occur. Analysis and characterization of the gaseous and volatile chemicals and smoke particulates was therefore needed to fully understand the chemical composition of the smoke to which firefighters are exposed.

There is an obvious need for SCBA use by firefighters, and firefighters are trained to use the equipment when exposed to adverse environmental conditions such as high temperatures and

carbon monoxide levels. SCBA are typically not used during the overhaul phase when the direct smoke or other threat from the fire is assumed to have diminished. During these overhaul operations, firefighters may inhale unknown concentrations of residual gases and/or smoke particles contaminated with absorbed chemicals. Depending upon the smoke particle sizes, the particles may remain embedded in respiratory and pulmonary systems and pose a long-term health threat. The gases, condensed liquids and smoke particulates generated during the various stages of fire growth, as well as during firefighting efforts, are characterized for residential fires in this study.

SCBA may also not be used during potentially hazardous yet tolerable situations such as outside fires or other limited exposure activities that take place on the fire ground. Outside fires could include vehicles, brush, detached garages, smaller structures such as sheds and dumpsters, etc. Limited exposure activities could include defensive firefighting operations where firefighters are not inside a structure but directing hose streams into the structure from the outside, outside ventilation operations where windows are being broken or holes are being cut in the roof, operating the pump, positioning ladders around the structure, commanding the incident, investigating the fire, etc. During all of these activities the use of SCBA may be limited or non-existent.

SCBA usage for firefighting operations has the same practical limitations as SCUBA for underwater exploration – limitations on the amount of air that can be stored in the carried cylinder along with the user's physiology and exertion level restricts the amount of time available for entry (descending), exit (ascending) and actual firefighting (exploration). As the firefighter's entry/exit path becomes more convoluted, such as for large fire incidents, the amount of air left for firefighting is diminished. In some cases, there may not therefore be any air left for actual firefighting. To extend the time a user has available for firefighting, the user may opt to conserve their air supply by not engaging the SCBA until entry is well underway. In extreme but unfortunately relatively common incidents like wildfires, very long durations in remote locations render SCBA usage impractical.

Beyond the air capacity limitation, SCBA weight, bulk, dexterity limitation, complication of communication and limiting of vision are a few other reasons a firefighter may remove their SCBA, especially during a long duration incident.

While it is relatively obvious when respiratory protective equipment is needed, such as situations where gas concentrations exceed levels determined to be Immediately Dangerous to Life or Health (IDLH), it is less clear when its use can be discontinued. Beyond the magnitude of the exposure hazard, there is a duration element to exposure hazard. The impact of a high concentration, short duration exposure could be dramatically different from that of a low concentration, long duration exposure.

In addition to hazards posed by smoke inhalation, smoke deposits and condensed residues accumulate on firefighting garments and skin from fire exposure and subsequent overhaul operations and remain on firefighter personal protection equipment and skin until cleaned. These contaminants may lead to further exposure to firefighters and other individuals that come in contact with the firefighter personal protection equipment by inhalation and skin absorption.



This study aims to further mitigate adverse health effects in firefighters by providing data to better understand the respiratory and contact hazards faced by firefighters, and the associated long term implications of exposure.

## **1.1 PREVIOUS RESEARCH**

### **1.1.1 RESEARCH ON FIREFIGHTERS**

Research studies analyzing the effects from firefighter exposures to gaseous effluents during fire exposure began more than three decades ago.<sup>3,4,5</sup> These studies focused on personal air samples collected during suppression and overhaul by Boston firefighters. Measurement and analysis of gaseous effluents have provided useful information needed to understand chemical exposure during firefighting activities. These studies assisted in improvements in design and encouragement of use of SCBA. The first experiments measured oxygen and carbon monoxide concentrations using personal air samplers. Measurements and methods were expanded in the subsequent experiments to include oxygen (bag sample/paramagnetic analyzer at firehouse), carbon dioxide (bag sample/detector tubes at firehouse), carbon monoxide (bag sample/ecolyzer at firehouse), nitrogen dioxide (13x molecular sieves impregnated with triethanolamine), hydrogen chloride (sieves impregnated with triethanolamine), hydrogen cyanide (30-60 mesh ascarite) and particulate content (gravimetric/25mm glass fibers). The sampling program suggested it was impossible for the firefighters to anticipate the conditions under which breathing apparatus was necessary. It was recommended that until a suitable instrument was available to monitor the exposure conditions, breathing apparatus should be used continuously in all structural fires.

In the mid 1980's a study was conducted that included instrumenting firefighters from the Dallas Fire Department with personal sampling devices.<sup>6</sup> Samples were collected at residential fires in areas with light to dense smoke of low thermal energy. Sampling methodologies included gas-grab and personal sampling devices. Gas-grab air samples were analyzed for carbon monoxide, hydrogen cyanide, formaldehyde and acetaldehyde by infrared spectrometry and organics by GC/MS. Colorimetric detector tubes were used for personal sampling of carbon monoxide, hydrogen chloride, hydrogen cyanide, and formaldehyde and charcoal tubes were used for organics. This study identified organic compounds within the gases that gave insight to a potential health hazard not yet considered. The organic compounds were the products of free radical reactions and as free radicals their potential as toxics was enormous according to the authors.

In the late 1980's field experiments were conducted in which Buffalo firefighters collected samples during the suppression and overhaul stages of fires.<sup>7</sup> Measurements included carbon monoxide, hydrogen chloride, hydrogen cyanide, sulfur dioxide, benzene and formaldehyde (calorimetric detector tubes) and dichlorofluoromethane, methylene chloride, trichloroethylene, chloroform, perchloroethylene, toluene, and trichlorophenol (charcoal sorbent tubes). Collection tubes were analyzed by GC/MS. Particulate samples were collected using glass fiber filters. Temperature was also estimated with color detector strips. The study concluded that many of the materials found have been implicated in the production of cardiovascular, respiratory, or neoplastic diseases, which may provide an explanation for the alleged increased risk for these illnesses among firefighters.

In the early 1990's research was conducted on the effectiveness of SCBA.<sup>8,9</sup> These field experiments were conducted by instrumenting firefighters with instruments to examine gas concentrations inside and outside the SCBA mask during knockdown and overhaul operations. Measurements and methodologies included gases (Tedlar bags/on-site FTIR), hydrochloric acid (silica gel tube/GC), hydrofluoric acid (silica gel tube/GC), nitric acid (silica gel tube/GC), sulfuric acid (silica gel tube/GC), hydrogen cyanide (soda lime tube/Konig reaction), acetaldehyde (polymer tube/GC/FID), formaldehyde (polymer tube/GC/FID), acrolein (polymer tube/GC FID), volatile organic compounds (charcoal tube/GC/FID/spectrometry), fibers (cellulose ester filter/phase contrast microscopy), bulk materials (hand collected/polarized light microscopy), particle size distribution (cascade impactor/gravimetric), polynuclear aromatic hydrocarbons (PTFE filter/GC/FID), and carbon monoxide (direct reading meter/electrochemical cell). Analysis was expanded to include short-lived reactive species (chemiluminescence field measurement) and long-lived free radicals (electron spin resonance spectroscopy) a couple years later. These results provide a plausible mechanism to explain the known phenomena of "incapacitation without cause" as well as chronic lung injury related to smoke inhalation.

In 1996, research expanded to include health concerns of fire investigators resulting from extended exposure durations while conducting fire scene investigations.<sup>10</sup> Air samples were collected during the post-fire investigation period at two house fires and three staged fire scenes. Measurements taken included hydrogen cyanide (soda lime tube/spectrophotometry), inorganic acids (ORBO 53 sorbent tubes/ ion chromatography), aldehydes (XAD -2 sorbent tubes/GC-FID), formaldehyde (Impinger/spectroscopy), polynuclear aromatic hydrocarbons (Zeflour filter on ORBO 42 sorbent tube/HPLC), volatile organic chemicals (VOC) (thermal desorption tubes/GC/MS), solvents (charcoal sorbent tube/GC-FID), metals (MCE filter/ICP), total particulate (PVC filter/gravimetric), respirable particulate (PVC filter/gravimetric), Grimm portable dust monitoring, and elemental/organic carbon (quartz fiber filters/optical). Although the environmental sampling conducted during this study indicated that most contaminant concentrations did not exceed the relevant evaluation criteria, it still indicated that the potential for hazardous exposure existed. Additionally, the sampling indicated the potential for exposure to carcinogens existed to some extent.

In the early 2000's field research experiments were conducted in which Phoenix firefighters collected air samples during the overhaul stage from structural fires.<sup>11</sup> Personal air samples were analyzed for aldehydes (DNPH tube), benzene (charcoal tube), toluene (charcoal tube), ethyl benzene (charcoal tube), xylene (charcoal tube), hydrochloric acid (ORBO 53 tube), polynuclear aromatic hydrocarbons (PTFE filter/ORBO 43 tube), respirable dust (PVC filter), and hydrogen cyanide (soda lime tube). Direct reading gas analyzers monitored carbon monoxide, hydrogen cyanide, nitrogen dioxide, and sulfur dioxide. Air samples collected using area sampling stands were analyzed for asbestos (0.8  $\mu\text{m}$ , 25mm, MCE filter), metals (cadmium, chromium, lead) (0.8  $\mu\text{m}$ , 37mm, MCE filter), and total dust (5  $\mu\text{m}$ , 37mm, PVC filter). This study identified exposure levels exceeding recommended ceiling limits for acrolein, formaldehyde and glutaraldehyde in at least one of the monitored fires; they also identified benzene, nitrogen dioxide and sulfur dioxide levels in excess of STELs in at least two of the monitored fires. The authors recommended respiratory protection use during overhaul activities and that carbon monoxide should not be used as an indicator gas for other contaminants found in the overhaul atmosphere.

The field research on potential exposures to firefighters during overhaul operations was later expanded to include field incidents in which Phoenix and Tucson firefighters conducted overhaul operations.<sup>12</sup> The Phoenix firefighters connected a filter to their face piece in 7 actual fires and 2 training fires and the Tucson firefighters used no protection during 5 actual fires and 2 training fires. After exposures blood was drawn and tested and lung function was tested. Measurements included four-gas direct-read meters (configured to detect carbon monoxide, nitrogen dioxide, sulfur dioxide, and methane) and single-gas meters (configured for hydrogen cyanide). Sorbent tube samples were collected for aldehydes, acetaldehyde, acrolein, benzaldehyde, formaldehyde, glutaraldehyde, isovaleraldehyde, benzene, hydrogen chloride, and sulfuric acid. Hydrogen cyanide was measured with sorbent tubes in Phoenix only. In Tucson, lead, cadmium, and chromium were measured in a personal total dust sample. Respirable dust was sampled using personal cyclone samplers equipped with pre-weighed polyvinyl chloride filters. The authors concluded that firefighter exposures during overhaul have the potential to cause changes in spirometric measurements and lung permeability, and self-contained breathing apparatus should be worn during overhaul to prevent lung injury.

Also in 2001, field experiments were conducted in which firefighters collected samples from structural fires with Summa canisters when they felt SCBA would be removed.<sup>13</sup> Collected samples were analyzed by GC-MS for 144 target compounds in selected ion mode and scan mode. The authors concluded that in spite of the small number of fire samples collected, the consistency of the results obtained indicates that there may be less variability in VOC exposures between fires than had been previously thought. Given the toxicity/carcinogenicity of those VOCs that were found in the highest concentrations, particularly benzene, 1,3-butadiene, and styrene, investigation of time-integrated personal exposures of firefighters to VOCs is warranted.

Most recently in 2007, laboratory experiments with a test chamber to simulate overhaul smoke conditions to evaluate the ability of air purifying respirator cartridges to protect firefighters were conducted.<sup>14</sup> Measurements included carbon monoxide with a single gas meter, 91 other chemical compounds using standard test methods [aldehydes (EPA T011, 15 compounds), methylisothiocyanate (OSHA 2), polynuclear aromatic hydrocarbons (NIOSH 5506, 16 compounds), hydrocarbons (MC-MS scans EPA T01/T02, 59 compounds), particle concentrations (personal DataRams), respirable dust (gravimetric NIOSH 0500), and free radicals (37mm cassettes using PVC filters)]. It was concluded that the respirators do not fully protect during overhaul exposure.

Also in 2007, a study was conducted that focused on wildland firefighter exposure to smoke.<sup>15</sup> The study examined the involvement of free radicals in smoke toxicity and the relationship between particle size and free radical generation. Samples were collected from a wildfire in Alaska, preserved and then shipped to a laboratory for analysis. Electron spin resonance was used for analysis of the wildfire smoke. Further study of reactive oxygen species was conducted using analysis of cellular hydrogen peroxide generation, lipid peroxidation of cellular membranes and DNA damage. The results demonstrated that coarse size-range particles contained more carbon radicals per unit mass than the ultrafine particles; however, the ultrafine particles generated more OH radicals in the acellular Fenton-like reaction. The ultrafine particles also caused significant increases in hydrogen peroxide production by monocytes and lipid

peroxidation. All particle sizes showed the ability to cause DNA damage. The authors conclude that the radical generation and the damage caused by them is not only a function of surface area but is also influenced by changing chemical and other characteristics due to particle size.

A 2007 NIOSH Alert publication<sup>16</sup> recommends that “exposure to carbon monoxide and other fire contaminants is controlled through proper management at the fire scene and proper use of respiratory protection.” The benefits of self-contained breathing apparatus and personal protection equipment is well known and documented, however, what is not known is the long-term effects of exposure to smoke particulates on firefighter skin, lungs, and lasting effects from contaminated gear. The 2007 NIOSH Alert identified the impact of smoke particulate matter on fire fighter health:

“Fire fighters have significant exposure to fire smoke particulate matter during fire suppression. Studies in the general population suggest particulate matter, as a component of air pollution, has cardiovascular effects. For example, long-term repeated exposure to elevated concentrations of particulate matter has been associated with cardiovascular mortality and the initiation/progression of atherosclerosis. In addition, short-term exposure to fine particulates has been associated with triggering heart attacks, particularly among people with pre-existing heart disease. These findings have implications for the fire service given fire fighters’ exposure to fire smoke particulate matter.”

A 2006 statistical study identified that firefighters are at 100% greater risk of testicular cancer, 50% greater risk of non-Hodgkin’s lymphoma and multiple myeloma and 28% greater risk of prostate cancer compared to the general population.<sup>17</sup> The study further recommends that the findings raise a red flag and should encourage further studies, especially research that better characterize the type and extent of exposures to firefighters. Fire crews use protective clothing and equipment to shield them from heat and chemicals when they are fighting the fire. However, when they take their protective equipment off they are at risk of inhaling cancer-causing chemicals and having these chemicals absorbed through the skin. While firefighters are protected from heat and carbon monoxide, there needs to be consideration of how to protect them from long-term secondary exposure to cancer-causing chemicals.<sup>18</sup>

Two additional publications did not involve experimental research but highlighted the problem and work towards solutions. The first is from a workshop held by the National Institute of Standards and Technology (NIST).<sup>19</sup> It highlighted the need and focused on the potential for real time particle monitoring for firefighters. The research needs determined by the workshop included a better understanding of the health effects for firefighters from overhaul, particulate characterization in overhaul, detector response in overhaul, demonstration of benefits, hazard of overhaul, and new filter cartridge development.

The second document is a very comprehensive literature search completed by the Fire Protection Research Foundation (FPRF).<sup>20</sup> Some of their key findings include a higher rate of adverse long-term health effects, changing character of fire related respiratory hazards and a need for recognition of dynamics of fire related respiratory hazards. Future research suggested includes the establishment of firefighter respiratory exposure measurement thresholds, determine the best

detection and monitoring field practice, identify and better characterize the overhaul phase of the fire and to clarify the causes of acute and long-term adverse health effects in firefighters. All these studies demonstrate the importance of better protecting the firefighters during the fire mitigation efforts. More detail on each of these studies and more relevant studies can be found in the project literature review location in Appendix A.

### **1.1.2 HEALTH ASSESSMENT OF FIREFIGHTER EXPOSURE CONDITIONS**

#### **Respiratory**

Previous firefighter exposure assessments have demonstrated the potential for firefighter exposures to respiratory toxicants, including exposures at levels exceeding occupational regulatory limits of the Occupational Safety and Health Administration (OSHA) and/or recommended limits from the National Institute for Occupational Safety and Health (NIOSH) or the American Conference of Governmental Industrial Hygienists (ACGIH). These airborne exposure levels were observed during firefighting activities, including overhaul.<sup>8,11</sup>

Specific potential exposures of concern for firefighters because of their potential respiratory toxicity include: (1) asphyxiants (such as carbon monoxide, carbon dioxide and hydrogen sulfide); (2) irritants (such as ammonia, hydrogen chloride, particulates, nitrogen oxides, phenol and sulfur dioxide); (3) allergens, and (4) respiratory carcinogens (such as chromium and polycyclic aromatic hydrocarbons).

The previous studies of pulmonary function testing have examined whether acute and/or chronic changes in test results occur in firefighters. Acute changes in spirometric parameters, including forced expiratory volume at 1 second (FEV1) and forced vital capacity (FVC) have been observed in firefighters after they have engaged in firefighting activities.<sup>12,21-23</sup> However, Brandt-Rauf et al noted that the changes were observed only among the firefighters who did not wear respiratory protective equipment during the firefighting activities. Studies of chronic changes in spirometric results in firefighters have produced mixed results. Some studies have shown a decline in values over time.<sup>24-26</sup> However, other studies have not identified chronic spirometric changes in firefighters.<sup>27-29</sup> The explanation for these mixed results relating to chronic effects is not known. However, researchers have hypothesized that the increased utilization of respiratory protective equipment over time and the administrative practice of transferring firefighters with respiratory disease away from active firefighting duties may explain the mixed nature of the results.<sup>30,31</sup>

One study demonstrated decreased diffusing capacity (DLCO), without changes in FVC or FEV1, over an 8 year period of follow-up testing.<sup>32</sup> Other respiratory studies have demonstrated increased airway reactivity among firefighters.<sup>33-35</sup> Other studies have examined the potential for acute lung inflammatory and permeability changes by measuring changes in serum levels of certain proteins produced in the lungs, including Clara Cell protein (CC16) and/or Surfactant-associated protein A (SP-A), after firefighting activities.<sup>12,36</sup> In each of these studies, increased levels of the CC16 protein were observed when firefighters were tested after engaging in firefighting activities. However, in a subsequent study, concentrations of CC16 and SP-A among firefighters were lower than in the police control group and the researchers hypothesized that firefighters' chronic exposures to respiratory toxicants led to loss of respiratory cells in distal areas of the lungs and this resulted in decreased levels of the pulmonary proteins.<sup>10</sup> Another

study measured changes cytokine levels, as inflammatory markers, in firefighters before and after firefighting activities and observed a decline in one of the markers (interleukin-10).<sup>37</sup> Subsequently researchers have begun utilizing genotyping to explore the role of polymorphisms in lung inflammation among firefighters.<sup>38,39</sup>

Previous firefighter studies have not focused on the potential for health effects related to work-related firefighter exposures to ultrafine particles (UFPs). However, research related to the specific contribution of the ultrafine particles to respiratory health effects in the general population, as well as in worker populations, has been expanding rapidly.<sup>40</sup> In the 1990s, researchers began to postulate that the unique physical characteristics of ultrafine particles might lead to their playing a key role in the health effects observed related to air pollution. Studies over the past few years have begun to address the potential mechanisms of toxicity related to the unique physical and chemical characteristics of the ultrafine particles.

Initial ultrafine particle studies pertained to their potential role in respiratory health effects. For example, one study demonstrated that decreased peak expiratory flow and increased cough in adults with asthma were more strongly associated with ultrafine particle exposures than with the categories of larger particles, fine or coarse particle exposures.<sup>41</sup>

Studies also have revealed the high efficiency of lung deposition of ultrafine particles deep into the lung tissue. Studies have suggested that subjects with underlying lung disease, including asthma or COPD, or who are exercising had increased lung deposition of ultrafine particles compared to healthy individuals.<sup>42</sup>

Other potential unique pulmonary physiologic effects related to ultrafine particles have been studied.<sup>43-45</sup> Ultrafine particles are capable of gaining entry to pulmonary interstitium and vasculature and thereby potentially being translocated to other body tissues, including the cardiovascular system, nervous system and the liver and avoid phagocytosis by lung macrophages.<sup>43,46</sup> Also, UFPs are capable of carrying significant amounts of air toxics, such as metals and polycyclic aromatic hydrocarbons. Exposure to ultrafine particles induces inflammation and oxidative stress responses in the lungs.<sup>47</sup>

Previous research studies have examined firefighter exposures and potential respiratory health effects in firefighters involved in other settings, including prescribed burns, forest fires and bush fires.<sup>48-51</sup>

Many of the studies of respiratory health effects in firefighters have led researchers to note the potential for adverse respiratory effects as the basis for their recommendations for more consistent use of respiratory protection during firefighting, including during overhaul.<sup>12,23</sup> Preliminary research to identify the most appropriate type of respiratory protective equipment and the most appropriate method of utilization of such equipment in order to limit firefighters' workplace exposures also has been undertaken.<sup>14</sup>

### **Cardiovascular**

Coronary heart disease is responsible for 45% of the approximately 100 annual firefighter deaths while on duty<sup>52,53</sup>. During fire suppression, which includes knockdown to extinguish the fire or

limit its growth, followed by overhaul to prevent reignition of partially burned material, firefighter deaths from acute cardiovascular events occur at a rate 10 to 100 times higher than that during non-emergency duties<sup>54</sup>. Firefighters also experience nonfatal coronary heart disease events at elevated rates during alarm response and fire suppression compared to non-emergency activities<sup>55,56</sup>.

Risk factors for coronary heart disease in firefighters may be personal and/or work-related. Personal risk factors include hypertension, obesity, elevated serum cholesterol and triglyceride levels and smoking<sup>57-61</sup>. Potential work-related risk factors include excessive noise levels, physical, heat and psychological stress, dehydration, extended work shifts and exposure to chemical asphyxiants, such as carbon monoxide, hydrogen cyanide and hydrogen sulfide, any of which could precipitate an acute cardiovascular event either *de novo* or in individuals with underlying cardiovascular disease<sup>8,11,12,21,22</sup>. A role for workplace factors was suggested by an altered circadian distribution of on-duty deaths from coronary heart disease compared to the general population, with a highest odds ratio during fire suppression activities<sup>12</sup>.

In general population studies a correlation has been established between increased exposure to urban air pollution related particulate matter (PM10 and PM2.5) and increased cardiovascular morbidity and mortality.<sup>62-66</sup> Although well defined for larger respirable particles, the corresponding relationship for ultrafine particles is currently unclear.<sup>62-66</sup> The density of ultrafine particles in urban air ranges from  $5 \times 10^3$  to greater than  $3 \times 10^5$  particles per cubic centimeter<sup>67</sup>, therefore, the values in the upper part of this range are comparable to those found during fire suppression in this study. In urban situations ultrafine particles are generated primarily from fossil fuel combustion sources such as coal powered utilities and diesel engines. Their number densities vary with time of day but decrease with distance from the source of generation as agglomeration increases particle diameters<sup>68</sup>. Short-term exposure to ultrafines at average levels as low as of  $1.2$  to  $1.45 \times 10^5$  particles/cubic centimeter induced a variety of changes in cardiovascular parameters in healthy volunteers in recent clinical studies<sup>69,70</sup>. A recent coronary heart disease study examining the impact of ultrafine diesel exhaust particle exposure in construction workers showed analogous adverse effects.<sup>71</sup>

The mechanisms underlying the observed increases in general population studies of cardiovascular morbidity and mortality from exposure to respirable particles have not been fully delineated and are the subject of ongoing research. Unique properties of ultrafine particles that may be involved include their reactivity, large surface area to mass ratios, and ability to transport other toxicants to target organs.<sup>69,72</sup> The large surface area to mass ratio enables the transport of large amounts of adsorbed toxic agents (such as those generated during a fire) to internal targets.<sup>62,63</sup> Translocation from the airways into the circulation and lymphatics and the resulting potential for cardiovascular toxicity has also been suggested as a component for ultrafine particle toxicity, but this potential mechanism remains controversial.<sup>73,74</sup> Other proposed mechanisms by which ultrafines may induce adverse cardiovascular effects include induction and release of mediators of systemic inflammation and alteration of autonomic balance (including heart rate variability)<sup>75</sup>. Physiologic responses reported include triggering of myocardial ischemia and infarctions as a result of acute arterial vasoconstriction<sup>76</sup>, endothelial dysfunction<sup>77</sup>, arrhythmias<sup>78</sup>, and pro-coagulant/thrombotic actions<sup>79-81</sup>. Long-term exposure to ultrafines has also been shown to enhance the chronic genesis of atherosclerosis.<sup>82</sup> Findings to date therefore

support the hypothesis that exposure to high levels of ultrafine particles presents a potential risk for coronary heart disease events in firefighters during fire suppression duties.

A variety of recommendations for firefighters and fire departments have arisen from previous analyses of firefighter on-duty coronary heart disease morbidity and mortality. These recommendations have focused on medical screening for coronary heart disease risk factors, medical management of personnel with known risk factors for the development or exacerbation of coronary heart disease, implementation of wellness/fitness programs, and the undertaking of further research activities and risk reduction measures (including personal protective equipment)<sup>16</sup>. “Heart presumption” workers’ compensation legislation, affording a presumption that coronary heart disease in a firefighter is work-related, has also been enacted in many states<sup>83</sup>.

Previous findings therefore support our hypothesis that exposure to high levels of ultrafine particulates generated during fire suppression is a significant risk for cardiovascular firefighter mortality during the performance of this duty. Coronary heart disease in firefighters may result from exacerbation of existing cardiovascular conditions, such as coronary artery disease, or precipitation of a *de novo* acute cardiovascular event. Repeated exposure may itself accelerate atherosclerotic cardiovascular disease. Especially pertinent is our finding of the continued presence of invisible ultrafine particulates at high levels during overhaul, when self-contained breathing apparatus is frequently removed by firefighters.

## **Cancer**

Firefighters may be exposed to a wide range of carcinogenic agents, including asbestos, benzene, styrene, polycyclic aromatic hydrocarbons (PAH) and certain heavy metals. The World Health Organization has classified occupational exposure as a firefighter as “possibly carcinogenic to humans” (Group 2B) on the basis of “limited evidence of carcinogenicity in humans”<sup>84</sup>.

Epidemiologic studies of firefighters have revealed an excess incidence of several types of cancer, a recent meta-analysis of the results of 32 studies indicating a probable increased risk in multiple myeloma, Non-Hodgkins lymphoma, and prostate and testicular cancers with a possible increase in eight other types of cancer (skin, malignant melanoma, brain, rectum, buccal cavity/pharynx, stomach, colon and leukemia)<sup>17</sup>. Another recent case-control study of California firefighters identified an association of firefighting as an occupation and certain types of cancer (testicular, malignant melanoma, brain, esophageal and prostate cancer).<sup>85</sup>

## **1.2 PROJECT OBJECTIVES**

The objectives of this research investigation were as follows:

1. Develop analytical test protocols for characterization of airborne smoke and gas generated by fires and accumulated products of combustion;
2. Characterize smoke and gases generated by materials used in residential structures and automobiles, residential structures and automobile fires under laboratory conditions, and as encountered in field incidents; and



3. Provide data and analysis to the fire, medical, and scientific community for several possible initiatives:
  - Advance understanding of the epidemiological effects of smoke exposure.
  - Develop situational assessment guidelines for self-contained breathing apparatus (SCBA) usage, personal protection equipment cleaning regimen and identify the importance of personal hygiene following fire effluent exposure.
  - Develop recommendations to change or create new test method standards and performance criteria for respirators used by first responders and the care and maintenance of personal protection equipment.
  - Development of new gas and smoke sensing technologies and measurement devices.
  - Provide data to the materials and additives industries to facilitate new smoke suppression technologies and improved end products.

### **1.3 TECHNICAL PLAN**

The technical plan consisted of 8 tasks that are detailed below.

#### **Task 1 – Literature Review**

Conduct a detailed review to document the existing literature on the exposure from fire effluents and smoke on fire fighters and the impact to their health. The review included technical sources related to (i) firefighting; (ii) fire safety and engineering; (iii) medical journals; (iv) and other relevant sources.

#### **Task 2 –Test Equipment and Sample Acquisition**

Select and acquire the test equipment and samples needed for this study. The samples included typical residential building construction materials, residential room contents, two used automobiles, and automobile components. The equipment included portable negative pressure particulate sampling systems and a portable, open path FTIR spectrometer (Fourier transform infrared) to compliment UL's existing particle analyzer and gas FTIR spectrometers.

Target substrates for evaluating smoke deposit and condensed residue included replaceable personal protective components (knee pads, elbow pads, etc.), target fabric swatches, and the filters for the portable negative pressure particulate sampling systems. Possible substrate material candidates were evaluated for their smoke and residue deposition and release potential in a laboratory setting. Final substrate material selection was based on these results.

#### **Task 3 – Conduct Material-Level Tests**

Material-level tests were conducted to investigate the combustion of individual components comprising the target samples under consistent, well-controlled radiant heating conditions. In these tests, material based combustion properties including weight loss rate, heat and smoke release rates, smoke particle size and count distribution, and effluent gas composition were characterized for a variety of natural, synthetic, and multi-component materials under flaming conditions. The results from these tests were used to assess the smoke contribution of individual materials.

Data was generated on samples of building construction materials commonly found in a residence including roofing materials, insulation, plywood, pipe, wiring, vinyl siding, treated wood and wood/plastic composite deck boards; residential building room contents (based on synthetic and natural materials) including carpeting, bedclothes, upholstery, and living room and bedroom furnishings. Data was also generated on samples commonly found in automobiles such as wiring, plastic, tires, fabric, foam, carpeting, and seals and gaskets.

#### **Task 4 – Conduct Large-Scale Fire Tests**

Real-scale laboratory fire tests were conducted at UL's large-scale fire test laboratory to collect and analyze the gas effluents, smoke particulates, and condensed residues produced during controlled, repeatable laboratory conditions. These tests served as a platform to develop and refine the condensed residue sampling techniques for field usage.

The nine fire scenarios included six residential building scenarios and two automobile scenarios. The six residential building scenarios included: (i) ventilated roof, (ii) kitchen; (iii) bedroom; (iv) living room; (v) treated wood deck; and (vi) wood-plastic composite deck structure. The living room scenario was repeated under limited-ventilated conditions. The two automobile scenarios included an engine compartment fire and a passenger compartment fire.

A simulated residential building was built based on a concrete block structure measuring approximately 12' by 14' in size with windows and one door, a typical residential roof structure and deck. The interior room surfaces were lined with gypsum board. The kitchen was outfitted with traditional wood cabinets, countertops, appliances, wood table and chairs. The bedroom and living room scenarios were outfitted with traditional furnishings. The deck structures were constructed of traditional sized lumber members and attached to the residential building. Two different deck surfacing materials, treated lumber and composite deck boards, and siding materials, vinyl and composite, will be used in the respective fire test scenario. Each scenario was instrumented with thermocouples, smoke obscuration equipment, and commercially available ionization and photoelectric smoke alarms.

The automobiles utilized in these tests were used four door passenger vehicles. Fires were started using small open flame ignition sources in the respective target compartment and allowed to propagate into the adjoining compartment.

In addition, during each of the nine fire tests, smoke samples were continuously collected for gas chemistry and smoke particle size and count analysis. Gas chemistry analysis was conducted using the gas FTIR analyzer and the Open-Path FTIR air monitoring equipment; smoke particle analysis was conducted using the particle analyzer. Firefighter personal atmosphere was monitored for gases and smoke particles. The collected smoke particles were further analyzed for elemental metal composition by ICP-MS (inductively coupled plasma/mass spectroscopy).

#### **Task 5 – Monitor Actual Fire Events**

Over a period of four months Chicago Fire Department designated personnel conducted personal gas monitoring and collected personal aerosol smoke samples at residential fires (knock-down, ventilation and overhaul) using the measurement techniques established in Task 4. Replaceable personal protective components (gloves and hoods) used by the firefighters during this time

period were collected on a regular basis by UL for subsequent chemical analysis to identify the chemical composition of the smoke residue.

Chicago Fire Department designated personnel were trained at UL's fire test facilities on the personal data collection systems, the condensed residue target swatches, and the Open path FTIR Air Monitoring equipment as a part of this task.

### **Task 6 – Data Compilation and Analysis**

The characterization data developed in Task 2 for the test samples were compiled for future reference purposes. Data from material-level tests (Task 3) were used to compare the combustion properties of individual materials identified in Task 2. Combustion, gas effluent, and smoke data generated in Tasks 3 through 5 were analyzed and compared for the different scales of testing investigated for this project.

### **Task 7 – Medical Analysis by Medical Experts**

Compiled smoke data (gas effluents, particle size distributions, and condensed residues) were provided to a University of Cincinnati College of Medicine medical research team led by Dr. James Lockey to assess the possible effects of chemical-laden smoke particulate to firefighters. This review took into consideration the potential toxicity of the chemical agents identified on the particulates and the potential adverse health effects.

### **Task 8 – Develop Final Project Report**

A comprehensive final report was developed to summarize the details of CFD responded fire events, real-scale laboratory fire scenarios, small-scale tests, sample assembly construction, test instrumentation and procedures, and the test results. Additionally, the report detailed the chemical make-up of the smoke particulates to which firefighters were exposed during both actual fire events and laboratory-scale tests, and the resulting potential health effects from those exposures. The report also included digital photographs. The publication and project results are being shared with technical experts through presentations at key fire protection venues including the NIOSH, Fire Department Instructors Conference (FDIC), US Fire Safety Council, the National Fire Protection Association (NFPA) Standards Committee, FEMA, and others.

The results of this investigation (Task 8) are described herein. The report is organized in seven chapters that cover the technical plan as presented in Table 1-1.

**Table 1-1: Report Organization**

| <b>Technical Plan</b>                          | <b>Chapter/Appendix</b>  |
|--|--|
| Task 1 – Literature Review                     | Chapter 1/Appendix A   |
| Task 2 – Test Equipment and Sample Acquisition | Chapter 2  |
| Task 3 – Conduct Material Level Tests`         | Chapter 3  |
| Task 4 – Conduct Large-Scale Fire Tests        | Chapter 4/Appendix B, Appendix C   |
| Task 5 – Monitor Actual Fire Events            | Chapter 5, Chapter 6   |
| Task 6 – Data Compilation and Analysis         | Included in Chapters 4, 5, and 6<br>Key findings summarized in Chapter 7 |
| Task 7 – Medical Analysis by Medical Experts   | Chapter 8  |

## 1.4 REFERENCES

1. Ahrens M. Home Structure Fires. Fire Analysis and Research Division, National Fire Protection Association, 1 Batterymarch Park, Quincy, MA 02169-7471 (2008).
2. Karter MJ Jr., Molis JL. Fire Fighter Injuries for 2006, NFPA Reports, NFPA Journal, Nov/Dec (2007).
3. Burgess WA, Lynch JJ, Buchanan P, et al. Minimum protection factors for respiratory protective devices for firefighters. *Am Ind Hyg Assoc J*; 38: 18-23 (1977).
4. Gold A, Burgess WA, Clougherty EV. Exposure of firefighters to toxic air contaminants. *Am Ind Hyg Assoc J*; 39: 534-539 (1978).
5. Treitman RD, Burgess WA, Gold A. Air contaminants encountered by firefighters. *Am Ind Hyg Assoc J*; 41: 796-802 (1980).
6. Lowry WT., Juarez L., Petty CS, Roberts B. Studies of toxic gas production during actual structural fires in the Dallas area. *J. Forens. Sci.* 30:59-71 (1985).
7. Brandt-Rauf PW, Cosman B, Fallon LF, Tarantini T, Idema C, Andrews L. Health hazards of firefighters: exposure assessment. *Br. J. Ind. Med.* 45:606-612 (1988).
8. Jankovic J, Jones W, Burkhard J, Noonan G. Environmental study of firefighters. *Ann Occup Hyg*; 35: 581-602 (1991).
9. Jankovic H, Jones W, Castranova V, et al. Measurement of short-lived reactive species and long-lived free radicals in air samples from structural fires. *Appl Occup Environ Hyg*; 8: 650-4 (1993).
10. Kinnes GM, Hine GA. Health Hazard Evaluation Report 96-0171-2692 Bureau of Alcohol, Tobacco, and Firearms Washington, D.C., HETA-96-0171-2692 NIOSH, Cincinnati, Ohio (1998).
11. Bolstad-Johnson DM, Burgess JL, Crutchfield CD, Storment S, Gerkin R, Wilson JR. Characterization of firefighter exposures during fire overhaul. *Am Ind Hyg Assoc J*; 61: 636-41 (2000).
12. Burgess JL, Nanson CJ, Bolstad-Johnson DM, Gerkin R, Hysong TA, Lantz RC, Sherrill DL, Crutchfield CD, Quan SF, Bernard AM, Witten ML. Adverse respiratory effects following overhaul in firefighters. *J Occup Environ Med*; 43: 467-73 (2001).
13. Austin CC, Wang D, Ecobichon, DJ, Dussault G. Characterization of Volatile Organic Compounds in Smoke at Municipal Structural Fires. *J of Tox and Environ Health, Part A*, 63:437-458 (2001).
14. Anthony TR, Joggerst P, James L, Burgess JL, Leonard SS, Shogren ES. Method Development Study for APR Cartridge Evaluation in Fire Overhaul Exposures. *Am. Occup. Hyg* 51:703-16 (2007).
15. Leonard SS, Castranova V, Chen BT, et al. Particle size-dependent radical generation from wildland fire smoke. *Toxicology* 236, 103-113 (2007).
16. NIOSH Alert: "Preventing Fire Fighter Fatalities Due to Heart Attacks and Other Sudden Cardiovascular Events", NIOSH, Department of Health and Human Services, Center for Disease Control, Publication No. 2007-133 (2007).

17. LeMasters GK, Genaidy AM, Succop P, Deddens J, Sobeih T, Barriera-Viruet H, Dunning K, Lockey J. Cancer risk among firefighters: a review and meta-analysis of 32 studies. *J Occup Environ Med*. Nov 48(11):1189-202 (2006).
18. Reinberg S. "Firefighters at High Risk for Cancer", *HealthDay News*, Nov. 10, 2006.
19. Bryant RA, Butler KM, Vettori RL, Greenberg PS. Real-Time Particulate Monitoring – Detecting Respiratory Threats for First Responders: Workshop Proceedings. NIST Special Publication 1051 (2007).
20. Grant C. Respiratory Exposure Study for Fire Fighters and Other Emergency Responders. Fire Protection Research Foundation (2007).
21. Sheppard D, Distefano S, Morse L, Becker C. Acute effects of routine firefighting on lung function. *Am J Ind Med* 9(4):333-40 (1986).
22. Large AA, Owens GR, Hoffman LA. The short-term effects of smoke exposure on the pulmonary function of firefighters. *Chest* 97(4):806-9 (1990).
23. Brandt-Rauf PW, Cosman B, Fallon LF Jr, Tarantini T, Idema C. Health hazards of firefighters: acute pulmonary effects after toxic exposures. *Br J Ind Med* 46(3):209-11 (1989).
24. Peters JM, et al. Chronic effect of fire fighting on pulmonary function. *N Engl J Med* 19:1320-1322 (1974).
25. Tepper A, Comstock GW, Levine M. A longitudinal study of pulmonary function in fire fighters. *Am J Ind Med* 20(3):307-16 (1991).
26. Sparrow D, Bossé R, Rosner B, Weiss ST. The effect of occupational exposure on pulmonary function: a longitudinal evaluation of fire fighters and non fire fighters. *Am Rev Respir Dis* 125(3):319-22 (1982).
27. Burgess JL, et al. Serum pneumoproteins: a cross-sectional comparison of firefighters and police. *Am J Ind Med* 44:246-253 (2003).
28. Musk AW, Peters JM, Wegman DH. Lung function in fire fighters, I: a three-year follow-up of active subjects. *Am J Public Health* 67:626-629 (1977).
29. Musk AW, Peters JM, Bernstein L, Rubin C, Monroe CB. Pulmonary function in firefighters: a six-year follow-up in the Boston Fire Department. *Am J Ind Med* 3(1):3-9 (1982).
30. Guidotti TL. Human factors in firefighting: ergonomic-, cardiopulmonary-, and psychogenic stress-related issues. *Int Arch Occup Environ Health* 64(1):1-12 (1992).
31. Mustajbegovic J, et al. Respiratory function in active firefighters. *Am J Ind Med* 40:55-62 (2001).
32. Burgess JL, et al. Longitudinal decline in measured firefighter single-breath diffusing capacity of carbon monoxide values: a respiratory surveillance dilemma. *Am J Respir Crit Care Med* 159:119-124 (1999).
33. Miedinger D, et al. Respiratory symptoms, atopy and bronchial hyperreactivity in professional firefighters. *Eur Respir J* 30:538-544 (2007).

34. Sherman CB, Barnhart S, Miller MF, Segal MR, Aitken M, Schoene R, Daniell W, Rosenstock L. Firefighting acutely increases airway responsiveness. *Am Rev Respir Dis* 140(1):185-90 (1989).
35. Sheppard D, Distefano S, Morse L, Becker C. Acute effects of routine firefighting on lung function. *Am J Ind Med* 9(4):333-40 (1986).
36. Bernard A, et al. Transient increase of serum Clara cell protein (CC16) after exposure to smoke. *Occup Environ Med* 54:63-65 (1997).
37. Burgess JL, et al. Rapid decline in sputum IL-10 concentration following occupational smoke exposure. *Inhal Toxicol* 14:133-140 (2002).
38. Burgess JL, et al. Longitudinal decline in lung function: evaluation of interleukin-10 genetic polymorphisms in firefighters. *J Occup Environ Med* 46:1013-1022 (2004).
39. Josyula AB, et al. Cytokine genotype and phenotype effects on lung function decline in firefighters. *J Occup Environ Med* 49:282-288 (2007).
40. Schmid O, et al. Dosimetry and toxicology of inhaled ultrafine particles. *Biomarkers* 14 Suppl 1:67-73 (2009).
41. Peters A, et al. Respiratory effects are associated with the number of ultrafine particles. *Am J Resp Crit Care Med* 155:1376-1383 (1997).
42. Chalupa DC, et al. Ultrafine particle deposition in subjects with asthma. *Env Health Perspect* 112:879-882 (2004).
43. Kreyling WG, et al. Ultrafine particle-lung interactions: does size matter? *19:74-83* (2006).
44. Ibald-Mulli A, et al. Epidemiological evidence on health effects of ultrafine particles. *J Aer Med* 15:189-201 (2002).
45. Maier KL, et al. Health effects of ambient particulate matter-biological mechanisms and inflammatory responses to in vitro and in vivo particle exposures. *Inhal Toxicol* 20:319-337 (2008).
46. Peters A, et al. Translocation and potential neurological effects of fine and ultrafine particles a critical update. *Particle Fibre Toxicol* 3:13 (2006).
47. Vinzents PS, et al. Personal exposure to ultrafine particles and oxidative DNA damage. *Env Health Perspect* 113:1485-1490 (2005).
48. Slaughter JC, Koenig JQ, Reinhardt TE. Association between lung function and exposure to smoke among firefighters at prescribed burns. *J Occup Environ Hyg* 1(1):45-9 (2004).
49. Swiston JR, Davidson W, Attridge S, Li GT, Brauer M, van Eeden SF. Wood smoke exposure induces a pulmonary and systemic inflammatory response in firefighters. *Eur Respir J* 32(1):129-38 (2008).
50. Gaughan DM, et al. Acute upper and lower respiratory effects in wildland firefighters. *J Occup Environ Med* 50:1019-1028 (2008).
51. Reisen F, Brown SK. Australian firefighters' exposure to air toxics during bushfire burns of autumn 2005 and 2006. *Environ Int* 35:342-352 (2009).

52. Fahy RF. U.S. firefighter fatalities due to sudden cardiac death, 1995–2004. Quincy, MA: National Fire Protection Association, June 2005. (Accessed February 21, 2009, at <http://www.nfpa.org/assets/files/PDF/OSCardiacDeath.pdf>.)
53. Firefighter fatality retrospective study. (Prepared for the Federal Emergency Management Agency, United States Fire Service, National Fire Data Center.) Arlington, VA: TriData Corp. (April 2002).
54. Kales SN, Soteriades ES, Christophi CA, Christiani DC. Emergency Duties and Deaths from Heart Disease among Firefighters in the United States. *New Engl J Med* 356:1207-15 (2005).
55. Holder JD, Stallings LA, Peeples L, Burress JW, Kales SN. Firefighter heart presumption retirements in Massachusetts 1997-2004. *J Occup Environ Med* 48:1047-53 (2006).
56. Geibe JR, Holder J, Peeples, L, Kinney AM, Burress JW, Kales SN. Predictors of on-duty coronary events in male firefighters in the United States. *Am J Cardiol* 101:585 (2008).
57. Yoo HL, Franke WD. Prevalence of cardiovascular disease risk factors in volunteer firefighters. *J Occup Environ Med* 51(8):958-62 (2009).
58. Glueck CJ, Kelley W, Wang P, Gartside PS, Black D, Tracy T. Risk factors for coronary heart disease among firefighters in Cincinnati. *Am J Ind Med* 30:331 (1996).
59. Clark S, Rene A, Theurer WM, Marshall M. Association of body mass index and health status in firefighters. *J Occup Environ Med* 44:940-6 (2002).
60. Soteriades ES, Hauser R, Kawachi I, Liarakapis D, Christiani DC, Kales SN. Obesity and cardiovascular disease risk factors in firefighters: a prospective cohort study. *Obes Res* 13:1756-63 (2005).
61. Ide CW. A longitudinal survey of the evolution of some cardiovascular risk factors during the careers of male firefighters retiring from Strathclyde Fire Brigade from 1985–1994. *Scott Med J* 45:79-83 (2000).
62. Laden F, Schwartz J, Speizer FE, Dockery DW. Reduction in Fine Particulate Air Pollution and Mortality. Extended Follow-up of the Harvard Six Cities Study. *Am J Respir Crit Care Med* 173:667–672 (2006).
63. Pope CA, Dockery DW. Health effects of fine particulate air pollution: lines that connect. *J Air Waste Manage Assoc* 56:709–742 (2006).
64. Peters A., Dockery DW, Muller JE, Mittelman MA. Increased particulate air pollution and the triggering of myocardial infarction. *Circulation* 103: 2810–2815 (2001).
65. Gold DR, Litonjua AA, Zanobetti A, Coull BA, Schwartz J, MacCallum G, Verrier RL, Nearing BD, Canner MJ, Suh H, Stone PH. Air pollution and ST-segment depression in elderly subjects. *Environ Health Perspect* 113:883–887 (2005).
66. Ibaldo-Mulli A, Timonen KL, Peters A, Heinrich J, Wölke G, Lanki T, Buzorius G, Kreyling WG, de Hartog J, Hoek G, ten Brink HM, Pekkanen J. Effects of particulate air pollution on blood pressure and heart rate in subjects with cardiovascular disease: a multicenter approach. *Environ Health Perspect* 112:369-77 (2004).
67. McMurry, PH; Woo, KS. Size Distributions of 3-100-nm Urban Atlanta aerosols: measurements and observations. *J Aerosol Med* 15:169-178 (2002).

68. Zhu Y, William C. Hinds WC, Shen S, Sioutas C. Seasonal and Spatial Trends in Fine Particulate Matter. Seasonal Trends of Concentration and Size Distribution of Ultrafine Particles Near Major Highways in Los Angeles. *Aerosol Sci Technol* 38:5–13 (2004).
69. Gong H Jr, Linn WS, Clark KW, Anderson KR, Sioutas C, Alexis NE, Cascio WE, Devlin RB. Exposures of healthy and asthmatic volunteers to concentrated ambient ultrafine particles in Los Angeles. *Inhal Toxicol* 20:533-45 (2008).
70. Samet JM, Rappold A, Graff D, Cascio WE, Berntsen JH, Huang YC, Herbst M, Bassett M, Montilla T, Hazucha MJ, Bromberg PA, Devlin RB. Concentrated ambient ultrafine particle exposure induces cardiac changes in young healthy volunteers. *Am J Respir Crit Care Med* 79:1034-42 (2009).
71. Torén K, Bergdahl IA, Nilsson T, Järholm B. Occupational exposure to particulate air pollution and mortality due to ischaemic heart disease and cerebrovascular disease. *Occup Environ Med* 64:515-9 (2007).
72. Wittmaack K. In search of the most relevant parameter for quantifying lung inflammatory response to nanoparticle exposure: particle number, surface area, or what? *Environ Health Perspect* 115:187-94 (2007).
73. Wiebert P, Sanchez-Crespo A, Seitz J, Falk R, Philipson K, Kreyling WG, Möller W, Sommerer K, Larsson S, Svartengren M. Negligible clearance of ultrafine particles retained in healthy and affected human lungs. *Eur Respir J* 28(2):286-90 (2006).
74. Furuyama A, Kanno S, Kobayashi T, Hirano S. Extrapulmonary translocation of intratracheally instilled fine and ultrafine particles via direct and alveolar macrophage-associated routes. *Arch Toxicol* 83:429-37 (2009).
75. Brook RD. Cardiovascular effects of air pollution. *Clin Sci*;115:175-187 (2008).
76. Urch B, Brook JR., Wasserstein D, Brook RD, Rajagopalan S, Corey P, Silverman F. Relative contributions of PM<sub>2.5</sub> chemical constituents to acute arterial vasoconstriction in humans. *Inhalation Toxicol* 16:345–352 (2004).
77. Törnqvist H, Mills NL, Gonzalez M, Miller MR, Robinson SD, Megson IL, Macnee W, Donaldson K, Söderberg S, Newby DE, Sandström T, Blomberg A. Persistent endothelial dysfunction in humans after diesel exhaust inhalation. *Am J Respir Crit Care Med* 176:395–40 (2007).
78. Dockery DW, Luttmann-Gibson H, Rich DQ. Association of air pollution with increased incidence of ventricular tachyarrhythmias recorded by implanted cardioverter defibrillators. *Environ Health Perspect* 113:670–674 (2005).
79. Nemmar A., Hoet PHM, Dinsdale D, Vermeylen J, Hoylaerts MF, Nemery B. Diesel exhaust particles in lung acutely enhance experimental peripheral thrombosis. *Circulation* 107:1202–1208 (2003).
80. Mutlu GM, Green D, Bellmeyer A, Baker CM, Burgess Z, Rajamannan N, Christman JW, Foiles N, Kamp DW, Ghio AJ, Chandel NS, Dean DA, Sznajder JI, Budinger GR. Ambient particulate matter accelerates coagulation via an IL-6-dependent pathway. *J Clin Invest* 117: 2952–2961 (2007).



81. Baccarelli A, Zanobetti A, Martinelli I, Grillo P, Hou L, Giacomini S, Bonzini M, Lanzani G, Mannucci PM, Bertazzi PA, Schwartz J. Effects of exposure to air pollution on blood coagulation. *J Thromb Haemostasis* 5:252–260 (2007).
82. Araujo JA, Barajas B, Kleinman M, Wang X, Bennett BJ, Gong KW, Navab M, Harkema J, Sioutas C, Lusk AJ, Nel AE. Ambient particulate pollutants in the ultrafine range promote early atherosclerosis and systemic oxidative stress. *Circ Res* 102:589-96 (2008).
83. At <http://www.iaff.org/HS/phi/phiStates.asp> (2009).
84. IARC. IARC monographs on the evaluation of carcinogenic risks to humans. Volume 98. Shift-work, painting and fire-fighting. Lyon: International Agency for Research on Cancer in press and *Lancet Oncology* 8:1065-66 (2007).
85. Bates MN. Registry-based case-control study of cancer in California firefighters. *Am J Ind Med* 50(5):339-44 (2007).

## CHAPTER 2: DESCRIPTION OF EXPERIMENTAL EQUIPMENT

### 2.0 INTRODUCTION

This section provides the basic description of the equipment used for the analysis of smoke, soot, and gases produced by combustion in material-level (*i.e.* bench-scale) tests, large-scale tests, and field events.

### 2.1 EXTRACTIVE FOURIER TRANSFORM INFRARED SPECTROSCOPY (FTIR)

The infrared (IR) source emits a broad band of different wavelength of infrared radiation. The IR radiation goes through an interferometer that modulates the radiation frequency. The interferometer performs an optical inverse Fourier transform on the entering IR radiation. The modulated IR beam passes through the gas sample where it is absorbed to various extents at different wavelengths by the various molecules present. Finally a detector detects the intensity of the IR beam. The detected signal is digitized and Fourier transformed by the computer to get the IR spectrum of the sample gas.

Gas effluent composition during the overhaul and sometimes during the whole duration of the fire test were characterized using a real-time MIDAC #I 1100 Fourier Transform Infrared (FTIR). Spectrometer equipped with a 10-meter path length optical cell. The UL FTIR equipment has gas calibration library to calculate the concentration of the key gas components detected.

FTIR was operated at  $0.5 \text{ cm}^{-1}$  wavenumber resolution over a mid-IR wavenumber range of  $650\text{-}4500 \text{ cm}^{-1}$ . Prior to the fire testing, a reference background based on the average of 64 spectra were collected. During the test, the gas effluent samples were continuously scanned at a rate of 4 averaged spectra per 8 seconds.

The relative quantitative analysis of various gases is based on the reference spectra of different gases collected at different concentrations in UL's FTIR library and commercial GRAMS/AI Library.

### 2.2 OPEN PATH FOURIER TRANSFORM INFRARED SPECTROSCOPY (OP-FTIR)

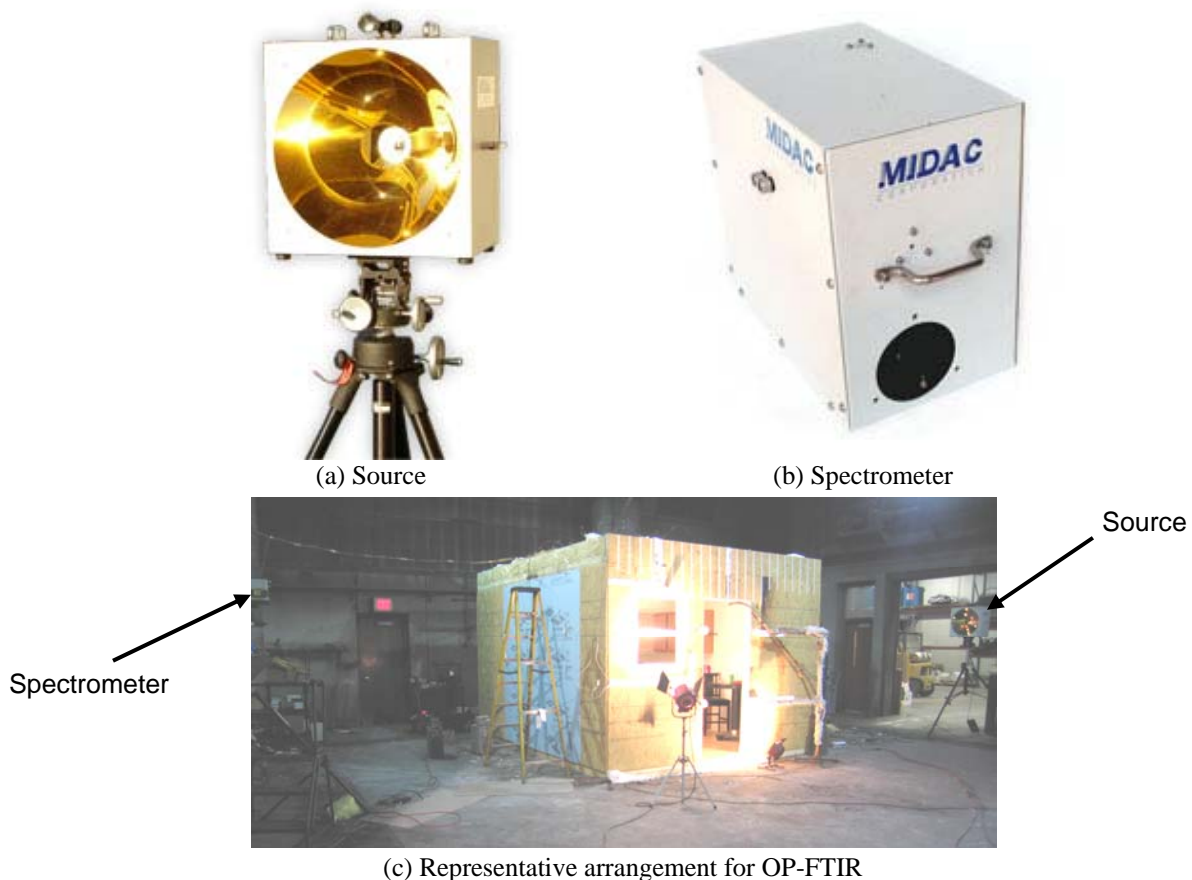
MIDAC M4411-F Open-path FTIR spectroscopy was used to provide real-time, simultaneous analysis of various effluent gases. The technology is identical in principle to classical laboratory FTIR spectroscopy, except the cell into which a sample would be injected is extended to the open atmosphere, Figure 2-1.

The OP-FTIR can be operated in active or passive mode. In active mode the spectrometer is aimed through the gas plume of interest at an infrared energy source resulting in an overall optical path length equal to the separation distance between the spectrometer and the infrared energy source. In the passive mode the spectrometer is aimed at the gas plume of interest and relies on fire itself for the infrared energy source. This results in an overall optical path length equal to the distance from the spectrometer to the fire. The maximum monitoring path length with UL OP-FTIR is 100m.

In both modes of operation, active and passive, it is assumed that the gases of interest are only found in the smoke plume. Thus the effective optical path length corresponding to the absorption measurements can be estimated from the plume width where the spectrometer is aimed.

Regardless of the operation mode utilized, the FTIR spectra were collected at  $0.5\text{ cm}^{-1}$  wavenumber resolution over a mid-IR wavenumber range to  $650\text{-}4500\text{ cm}^{-1}$ . Prior to the fire testing, a reference background based on the average of 64 spectra were collected. During the test, the gas effluent samples were continuously scanned at a rate of 4 averaged spectra per 5 seconds.

Gases present are identified and quantified via a computer-based spectral search from reference spectra of different gases collected at different concentrations in UL's FTIR library and commercial GRAMS/AI Library.



**Figure 2-1: Open Path FTIR components and example of active mode arrangement used for large-scale tests.**

### 2.3 WIDE RANGE PARTICLE SPECTROMETER (WPS)

Smoke particle size and count distribution was characterized using a Model WPS 1000XP wide range particle size spectrometer from MSP Corporation (WPS spectrometer).

The WPS spectrometer combines laser light scattering, electrical mobility and condensation particle counting technologies in a unique, single instrument with the capability of measuring the

concentration and size distribution of aerosol particles ranging from 10 to 10,000 nm (0.01 to 10  $\mu\text{m}$ ) in diameter. The instrument divides a 1 Liter/min sample flow between the dynamic mobility analyzer (DMA) and the light particle spectrometer (LPS) modules to develop the particle size distribution. The LPS module is sensitive to particle sizes greater than 200 nm (0.2  $\mu\text{m}$ ) whereas the DMA module is sensitive to particle sizes ranging from 10 to 500 nm (0.01 to 0.50  $\mu\text{m}$ ).

Particle sizes were measured by the DMA module at a rate of 2 seconds per size interval (bin). For the data reported herein, the DMA analyzer was set to obtain data for 24 size intervals resulting in an ensemble measurement time of 48 seconds. Particle size measurements by the LPS module are instantaneous, however the recorded count is an average over the 48-second ensemble measurement time. The analyzer was purged between successive ensemble measurements resulting in subsequent measurements being continuously collected at approximately 67-second intervals.

Smoke samples were diluted with nitrogen gas (UHP grade, 99.999%) as necessary to prevent saturation of the detection instrument, less than  $2 \times 10^7$  particles/cc. The sample flow and the nitrogen gas flows were controlled using rotameters.

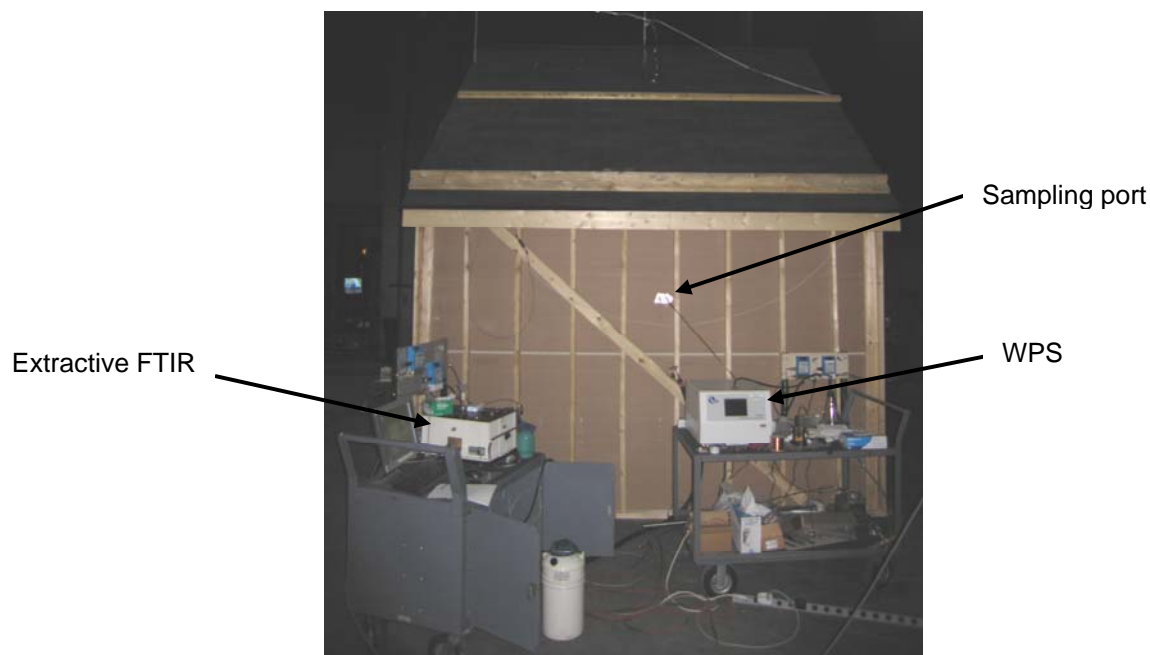


Figure 2-2: WPS and Extractive FTIR arrangement for attic fire test.

## 2.4 PERSONAL GAS MONITORING SYSTEM

Carbon monoxide (CO), hydrogen sulfide ( $\text{H}_2\text{S}$ ), sulfur dioxide ( $\text{SO}_2$ ), ammonia ( $\text{NH}_3$ ), nitrogen dioxide ( $\text{NO}_2$ ), and hydrogen cyanide (HCN) gases were analyzed using MX6 Ibrid portable personal gas monitor during the overhaul period, Figure 2-3. During the test the portable MX6 Ibrid was attached to the front of firefighter's gear as depicted in Figure 2-5.

The MX6 Ibrid is designed to detect six gases such as CO, H<sub>2</sub>S, SO<sub>2</sub>, NH<sub>3</sub>, NO<sub>2</sub> and HCN using electrochemical sensors. Electrochemical sensors operate by reacting with the gas of interest and producing an electrical signal proportional to the gas concentration. In order for gases to contact the sensor surface, they must pass through a small capillary-type opening and then diffuse through a hydrophobic barrier.

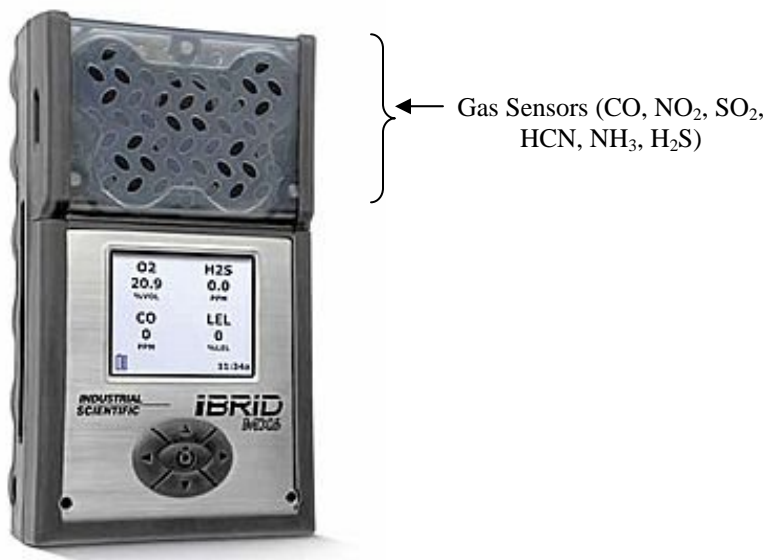


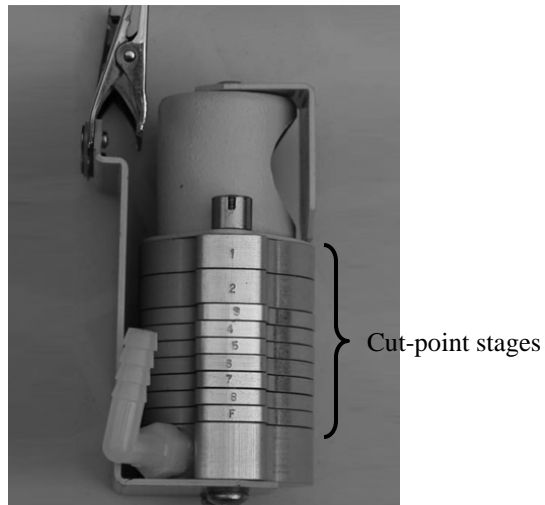
Figure 2-3: Personal Gas Monitoring System (MX6 Ibrid).

## 2.5 PERSONAL CASCADE IMPACTOR

A New Star Environmental Series 290 Marple Cascade Impactor, Figure 2-4, was used to characterize the smoke particle size distribution generated during the overhaul. The impactor has four stages with cut points 9.8, 3.5, 0.93 and 0.52  $\mu\text{m}$ . 34mm PVC substrate were used in all 4 stages and final filter is a 34 mm diameter PVC filter. The substrates were sprayed with silicon spray in order to minimize particle bounce.

The personal mounting bracket was attached to the lapel/pocket of the firefighter's gear, see Figure 2-5, during the overhaul period and operated at nominal 2 Liter per minute flow rate by a constant flow rate personal sampling pump attached to the belt and interconnected via tubing to the cascade impactor. During operation, particles larger than the cut-point of the first stage will impact on the perforated collection substrates. Then, the air stream flows through the narrower slots in the second impactor stage, smaller particles will impact onto the second collection substrate and so forth. After the last impactor stage, remaining fine particles are collected by the 34 mm PVC filter.

After usage, the personal impactors were overnighted for gravimetric analysis and subsequent inorganic elemental content analysis by ICP-MS (Section 2.8).



**Figure 2-4: Personal cascade impactor.**



(a) IBRID gas monitor and Marple particle impactor



(b) Pump for Marple Impactor

**Figure 2-5: IBRID gas monitor and Marple particle impactor attached to firefighter SCBA harness.**

## 2.6 BENCH TOP CASCADE IMPACTOR

Mass distributions of four different smoke particle size ranges generated during the fire test were characterized using MSP Corporation MDI 129 Cascade Impactor. This high flow rate, low-pressure drop cascade impactor is intended for general-purpose aerosol sampling.

There are 4 stages (10, 2.5, 1.0 and 0.25  $\mu\text{m}$  cut points) in the impactor. 75 mm aluminum foil substrates were used in all 4 stages and the final collection was completed using a 90 mm diameter glass fiber filter. The aluminum substrates were sprayed with silicon spray in order to minimize particle bounce. The substrates were weighed before and after testing for gravimetric analysis. During the fire test, a Magnahelic pressure gauge was used to monitor the inlet flow rate through the impactor. The exhaust port of the impactor is connected to the suction side of a vacuum pump. A flow control valve was attached to adjust the impactor inlet flow rate to 100 L/min.

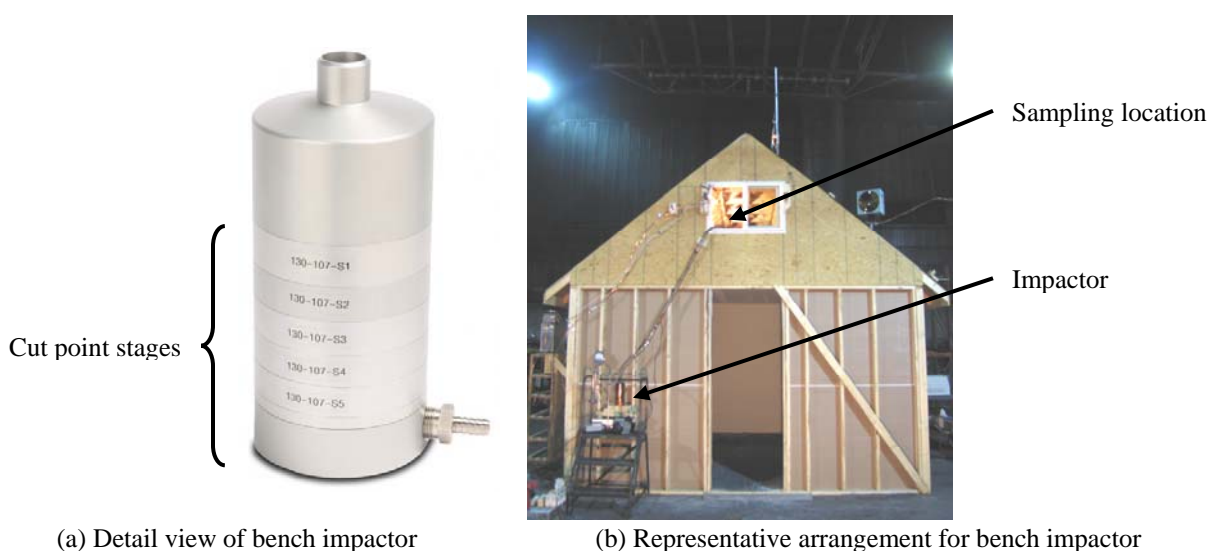


Figure 2-6: Bench impactor.

## 2.7 INDUCTIVE COUPLED PLASMA MASS SPECTROSCOPY (ICP-MS)

Inductively coupled plasma mass spectroscopy (ICP-MS) is a highly sensitive method for quantifying metals and some non-metals at ppb concentrations. The method is based on an ICP coupled with a mass spectrometer. Dissolved sample material is injected into the ICP where it the liquid carrier is evaporated and any dissolved solids are atomized. The high temperature argon plasma ionizes the atoms that can then be separated and detected by the mass spectrometer based on their mass to charge ratio.

## 2.8 GAS CHROMATOGRAPH MASS SPECTROSCOPY (GC-MS)

Gas chromatography mass spectroscopy is an effective technique for identifying volatile, semi-volatile and non-volatile components present in compounds using thermal desorption and pyrolysis technique.

The gas chromatograph utilizes a capillary column and the difference in the chemical properties between different molecules in a mixture will separate the molecules as the sample travels the length of the column. The molecules take different amounts of time (the retention time) to elute from the gas chromatograph, and this allows the mass spectrometer downstream to capture, ionize, accelerate, deflect, and detect the ionized molecules separately. The mass spectrometer does this by breaking each molecule into ionized fragments and detecting these fragments using their mass to charge ratio.

## **2.9 HYDRIDE GENERATION ATOMIC ABSORPTION SPECTROSCOPY (HG-AAS)**

Airborne mercury was collected using Hydrar tubes. Sample tubes were analyzed by hydride generation atomic absorption spectroscopy using modified NIOSH 6009 method. Hydride generation atomic absorption spectrometry describes one of the most accurate analytical techniques for trace analysis of these elements and is sensitive to picogram levels.

## **2.10 HIGH PRESSURE LIQUID CHROMATOGRAPHY (HPLC)**

Formaldehyde and PAH's were detected by high pressure liquid chromatography (HPLC) using modified EPA IP-6 method and modified NIOSH 5506 method respectively.

HPLC utilizes a column that holds chromatographic packing material (stationary phase), a pump that moves the mobile phase(s) through the column, and a detector that shows the retention times of the molecules. Retention time varies depending on the interactions between the stationary phase, the molecules being analyzed, and the solvent(s) used.

The sample to be analyzed is introduced in small volume to the stream of mobile phase. The analyte's motion through the column is slowed by specific chemical or physical interactions with the stationary phase as it passes through the length of the column. The amount of retardation depends on the nature of the analyte, stationary phase and mobile phase composition. The time at which a specific analyte elutes is called the retention time; the retention time under particular conditions is considered a reasonably unique identifying characteristic of a given analyte.

## **2.11 SUMMARY OF EXPERIMENTAL EQUIPMENT**

Several pieces of equipment were used to analyze the smoke, soot and gases produced by combustion in the material-level (*i.e.* bench-scale) tests, large-scale tests, and field events. Table 2-1 provides a summary of the experimental equipment that was used in the various phases of the project.



**Table 2-1: Sample collection and analytical techniques used for fire tests.**

| <b>Compounds/elements of interest</b>   | <b>Sampling system</b>              | <b>Analytical techniques</b> | <b>Detection limit</b>       |
|---|-------------------------------------|------------------------------|------------------------------|
| Various gases   | -                                   | Extractive FTIR              | 0.1 ppm                      |
| Various gases   | -                                   | OP-FTIR                      | 0.1 ppm                      |
| CO, H <sub>2</sub> S, SO <sub>2</sub> , NH <sub>3</sub> , NO <sub>2</sub> , HCN | Personal gas monitor                | Electrochemical Sensor       | 0.1 to 1 ppm <sup>[1]</sup>  |
| Particle size distribution  | -                                   | WPS                          | 10 nm                        |
| Particle size distribution  | Bench top cascade impactor          | Gravimetric                  | 100 µg                       |
| Particle size distribution  | Personal cascade impactor           | Gravimetric                  | 10 µg                        |
| Various inorganic elements in collected airborne particles                      | Personal cascade impactor           | ICP-MS                       | 0.04 to 1 µg <sup>[1]</sup>  |
| Various inorganic elements in collected airborne particles                      | Firefighters gloves and hoods       | ICP-MS                       | 0.05 to 1 ppm <sup>[1]</sup> |
| Mercury (airborne)  | Hydrar tube                         | HG-AAS                       | 0.0025 µg                    |
| Volatile and semi-volatile organic compounds                                    | Firefighters gloves and hoods       | GC-MS                        | 1 to 5 ppm <sup>[1]</sup>    |
| Benzene (airborne)  | Catecholamine treated charcoal tube | GC                           | 0.1 µg                       |
| Styrene (airborne)  | Catecholamine treated charcoal tube | GC                           | 1.2 µg                       |
| Formaldehyde (airborne)   | 2,4-DNPH treated silica gel tube    | HPLC                         | 0.1 µg                       |
| PAH's (airborne)  | Teflon filter                       | HPLC                         | < 0.1 µg                     |

Note: <sup>[1]</sup> Species dependent.

## CHAPTER 3: MATERIAL-LEVEL TESTS

Selected materials used in the large-scale fire test scenarios were characterized for chemistry by Fourier Transform Infrared Spectroscopy (FTIR) and combustibility under flaming conditions by oxygen consumption calorimetry (cone calorimeter). Developed smoke particle distributions and effluent gas concentrations were evaluated for flaming conditions.

### 3.0 SAMPLES

Material-level tests were conducted on products used in the large-scale fire test scenarios based upon the prevalence of the items in residential settings, the chemistry of their base material components, and their role in residential fires. Where the selected product was a composite item such as a mattress, individual components of the final item were investigated to provide better understand the contribution potential of the component. All of the selected materials, listed in Table 3-1, were procured from commercial sources.

Table 3-1: List of evaluated material-level test samples.

| Samples                 |                           |                              |
|-------------------------|---------------------------|------------------------------|
| Auto air intake plastic | Crib mattress             | Pressure treated deck lumber |
| Auto door panel plastic | Deck Chair                | PS insulation                |
| Auto headliner          | Deck chair pad            | PVC pipe                     |
| Auto hood insulation    | Deck table                | PVC siding                   |
| Auto seat               | Dresser composite board   | PVC wiring                   |
| Bed sheets              | Fiberglass insulation     | Room trim                    |
| Carpet                  | Housewrap                 | Shingle                      |
| Carpet padding          | Kitchen cabinet wood      | Sled                         |
| Carpeting and padding   | Latex paint on wall board | Sofa cover and padding       |
| Christmas tree          | Mattress materials        | Tar paper                    |
| Composite floor padding | OSB                       | Tire                         |
| Composite flooring      | Plastic deck box          | TV housing plastic           |
| Composite siding        | Plywood                   | Wood stud                    |
| Countertop              | Polyester                 | WPC deck board               |

### 3.1 EXPERIMENTAL

#### 3.1.1 Chemistry (FTIR)

Infrared spectral response of the materials was characterized in the solid-state using a Nicolet Nexus 470 FTIR with a Golden Gate KRS-5 diamond ATR accessory. Samples were scanned from 400 to 4000  $\text{cm}^{-1}$  wavenumber at a 4  $\text{cm}^{-1}$  resolution; 32 scans were averaged per recorded spectra.

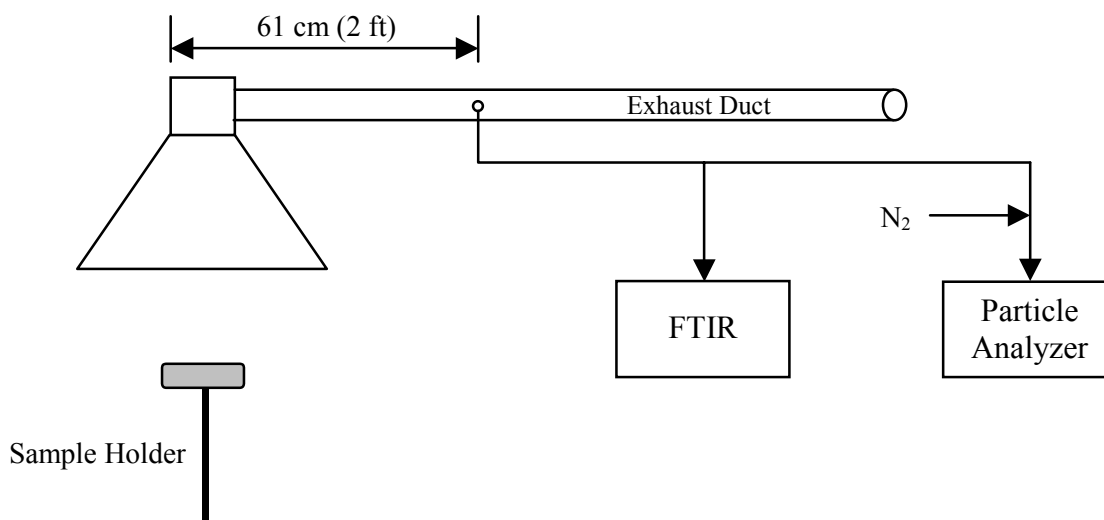
#### 3.1.2 Combustibility and Associated Developed Smoke and Gases under Flaming Conditions

The combustibility behavior of the foam materials was characterized under flaming conditions using a cone calorimeter in accordance with test method ASTM E 1354 *Standard Test Method for Heat and Visible Smoke Release Rates for Materials and Products Using an Oxygen*

*Consumption Calorimeter*<sup>1</sup>. Combustion products were obtained using a custom sampling system for characterization of the smoke particle size and count distribution and effluent gas concentrations. The test arrangement is shown in Figure 3-1.

The downstream facing smoke particle and effluent gas sampling port was located on the cone calorimeter exhaust duct, 0.6 m down stream from the cone hood. The sample stream was divided to the two respective spectrometers; each sample line was 3 m long with a 3.2 mm I.D. The sample line to the particle analyzer was diluted with nitrogen gas (UHP grade, 99.999%) to prevent saturation of the detection instrument. The sample line to the FTIR was maintained at 120 °C to prevent condensation of generated water vapor in the effluent gas stream.

Prior to each test, the sampling system lines were cleaned and the cone calorimeter, gas FTIR and WPS spectrometers, and the sampling system were purged with ambient air. Both of the spectrometers were checked to ensure that the background signal was insignificant prior to initiating a test.



**Figure 3-1: Test apparatus schematic for combustibility and associated developed smoke and gas measurements.**

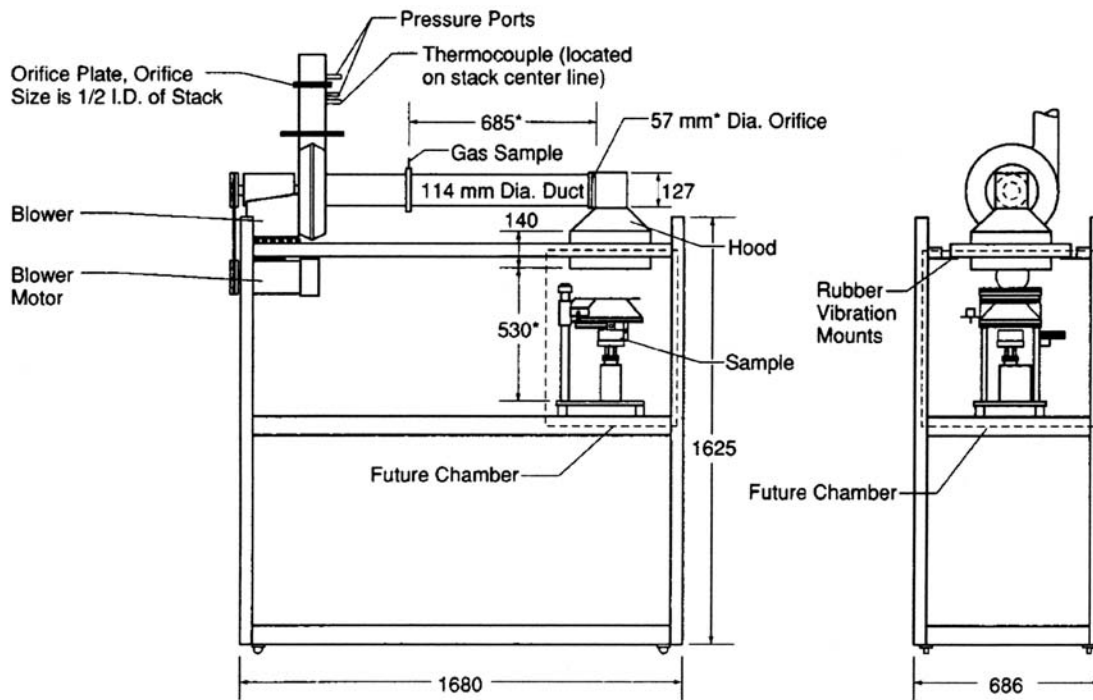
Although the sampling arrangement was designed to minimize any particle size bias, it is anticipated that there is a theoretical bias toward smaller particles due to the downstream facing sampling orientation. In addition, some particulates are anticipated to be lost due to adhesion to the sampling tube.

### Combustibility

The ASTM E 1354 cone calorimeter apparatus consists of a conical shaped electrical heater capable of heating a test sample with radiant heat flux of up to 100 kW/m<sup>2</sup>, a load cell, a laser

<sup>1</sup> ASTM E 1354 *Standard Test Method for Heat and Visible Smoke Release Rates for Materials and Products Using an Oxygen Consumption Calorimeter*, ASTM International, 100 Barr Harbor Drive, PO Box C700, West Conshohocken, PA 19428-2959, United States.

smoke obscuration system, and gas analysis equipment. A schematic of the cone calorimeter is shown in Figure 3-2.



**Figure 3-2: Schematic of ASTM E 1354 cone calorimeter (reprinted from ASTM E 1354).**

Foam test specimen measuring  $100 \times 100$  mm square were cut and tested in a horizontal orientation using an edge frame sample holder with a restraining grid (HEG) such that the intended outer surface of the material was exposed to the applied radiant heat flux.



**Figure 3-3: ASTM E1354 Cone calorimeter sample holder**

Flaming mode tests were performed at  $35 \text{ kW/m}^2$  radiant heat flux setting on the conical heater and using an electric spark igniter to ignite the thermal decomposition gases. Data was collected until flaming or other signs of combustion ceased. Samples were exposed until flaming combustion ceased for more than 2 minutes or for a maximum of 60 minutes (as specified in ASTM E1354) in order to collect sufficient data for this investigation. Observations regarding ignition time and physical changes to the sample (*e.g.* melting, swelling, or cracking) were also noted.

Heat and smoke release rates, effective heat of combustion, and specific extinction area were calculated using the procedures described in ASTM E 1354 and are summarized in the following equations.

Heat release relations:

$$\text{HRR} = \frac{\text{Measured heat}}{\text{Sample area}} [=] \text{ kW/m}^2 \quad \text{Eq. 1}$$

$$\text{Total Heat} = \frac{\int_{\text{ignition}}^{\text{completion}} \text{HRR} \cdot dt}{1000 \text{ MJ/kJ}} [=] \text{ MJ/m}^2 \quad \text{Eq. 2}$$

$$\text{Effective Heat of Combustion} = \frac{\text{Total Heat} \cdot \text{Sample area}}{\text{Total weight loss} \cdot 1000 \text{ kJ/MJ}} [=] \text{ kJ/g} \quad \text{Eq. 3}$$

Smoke release relations:

$$\begin{aligned} \text{SRR} &= \text{Volumetric flow rate} \times \frac{\text{Optical density}}{\text{Sample path length}} [=] \text{ m}^2/\text{s} \\ &= \text{Extinction Coefficient } (\epsilon) \times \text{Mass flow rate} \end{aligned} \quad \text{Eq. 4}$$

$$\text{Total Smoke} = \int_{\text{ignition}}^{\text{completion}} \text{SRR} \cdot dt [=] \text{ m}^2 \quad \text{Eq. 5}$$

$$\text{Specific extinction area} = \frac{\text{Total Smoke}}{\text{Total weight loss}} [=] \text{ m}^2/\text{g} \quad \text{Eq. 6}$$

Combining Eq. 4 through Eq. 6, it may be observed that the Smoke Yield is proportional to the Extinction Coefficient ( $\epsilon$ ) and Specific Extinction Area ( $\sigma$ ) as:

$$\text{Smoke Yield} = \frac{\epsilon}{\sigma} [=] \text{ dimensionless} \quad \text{Eq. 7}$$

Babrauskas and Mulholland<sup>2</sup> have been found that the Extinction Coefficient is relatively constant at 8,500 m<sup>2</sup>/kg for well-ventilated combustion of a wide variety of fuels.

### Developed Smoke Particles

Smoke particle size and count distribution were characterized using WPS spectrometer described in Section 2.3

The following notation is used in the remaining body of this chapter to distinguish the three levels of particle data collected on the WPS spectrometer:

<sup>2</sup> V. Babrauskas and G. Mulholland, Smoke and Soot Determinations in the Cone Calorimeter, Mathematical Modeling of Fires, American Society for Testing and Materials (1987).

G. Mulholland, ICFRE Conference, Chicago, IL (October 1999).

$n_i, d_i$  individual bin size data

$n_m, d_m$  mean ensemble data (the arithmetic mean of the 24 bins of data measured per ensemble) such that:

$$n_m = \frac{\sum_{i=1}^{24} n_i}{24} \quad \text{Eq. 8}$$

$$d_m = \frac{\sum_{i=1}^{24} n_i \cdot d_i}{\sum_{i=1}^{24} n_i} \quad \text{Eq. 9}$$

$N_m, D_m$  time averaged mean ensemble data (the arithmetic mean of all measured ensembles) such that:

$$N_m = \frac{\sum_{t=0}^{\text{finish}} n_m}{\text{number of scans}} \quad \text{Eq. 10}$$

$$D_m = \frac{\sum_{t=0}^{\text{finish}} d_m \cdot n_m}{\sum_{t=0}^{\text{finish}} n_m} \quad \text{Eq. 11}$$

### Effluent Gas Composition

Gas effluent composition was characterized using a MIDAC #I 1100 Fourier Transform Infrared (FTIR) Spectrometer equipped with a 10 meter path length optical cell. The UL FTIR equipment has gas calibration library to calculate the concentration of the key gas components detected.

Infrared spectra of the effluent gas were continuously collected at approximately 8 second intervals. Each spectrum was based on the signal average of 8 individual scans at a resolution of  $0.5 \text{ cm}^{-1}$ . Prior to testing, a background reference spectrum was collected. The background reference spectrum was based on the signal average of 64 individual scans at a resolution of  $0.5 \text{ cm}^{-1}$ .

A simple mixing model was used to deconvolute the effects of the FTIR gas cell retention time on the measured effluent gas concentrations. The relevant quantities are the fixed volumetric flow rate,  $\dot{v}_{in} = \dot{v}_{out} = \dot{v}$ , of the effluent gas sample through a well-mixed controlled volume

$V_o$  (the FTIR cell) at atmospheric pressure and a temperature of 120 °C. The mass flow rate for a given effluent gas component  $i$  leaving the control volume at constant air density  $\rho$  is:

$$\dot{m}_{i,out} = \frac{d(\rho VC_i)}{dt} = \rho C_i \frac{dV}{dt} + \rho V \frac{dC_i}{dt} = \rho C_{i,out} \dot{V} + \rho V \frac{dC_i}{dt} \quad \text{Eq. 12}$$

where  $C_i$  is the concentration of component  $i$ .

The mass flow rate for the given component  $i$  entering the control volume is:

$$\dot{m}_{i,int} = \frac{d(\rho VC_i)}{dt} = \rho C_i \frac{dV}{dt} + \rho V \frac{dC_i}{dt} = \rho \dot{V} C_{i,in} \quad \text{Eq. 13}$$

since  $dC_i/dt = 0$  for the incoming gas species at  $C_{i,in}$ . The mass balance for the gas is:

$$\dot{m}_{i,in} - \dot{m}_{i,out} = 0 \quad \text{Eq. 14}$$

Combining Eq. 12, Eq. 13, and Eq. 14 results in the deconvoluted incoming gas concentration:

$$C_{i,in} = \tau \frac{dC_i}{dt} + C_{i,out} \quad \text{Eq. 15}$$

such that the FTIR gas cell retention time  $\tau$  is defined as  $V_o/\dot{V}$ .

The following values were used for the calculations:

- $\dot{V}$  = measured FTIR sample flow rate
- $V_o$  = FTIR cell volume = 2 liters

In order to determine the total mass of the generated effluent gases, the deconvoluted FTIR concentrations  $[i]_{in}$  were corrected for temperature differences between the FTIR cell and the cone calorimeter sampling port, the cone calorimeter mass flow rate, and respective gas molecular weight as such:

$$\text{Mass}_{\text{gas}} = \int \left( [i]_{in} \cdot \frac{T_{\text{FTIR}}}{T_{\text{cone}}} \right) \cdot (\text{Cone Flow Rate}) \cdot \left( \rho_{\text{air}} \cdot \frac{\text{MW}_{\text{gas}}}{\text{MW}_{\text{air}}} \right) \cdot dt [=] \text{ g} \quad \text{Eq. 16}$$

where the density of air is  $353.22/T_{\text{cone}}$ .

The following values were used for the calculations:

- $T_{\text{FTIR}}$  = FTIR cell temperature = 393 K
- $T_{\text{cone}}$  = Cone effluent gas temperature measured at photocell
- $\text{MW}_{\text{air}}$  = Molecular weight of air = 28.97 g/mol

## 3.2 RESULTS

### 3.2.1 Combustibility

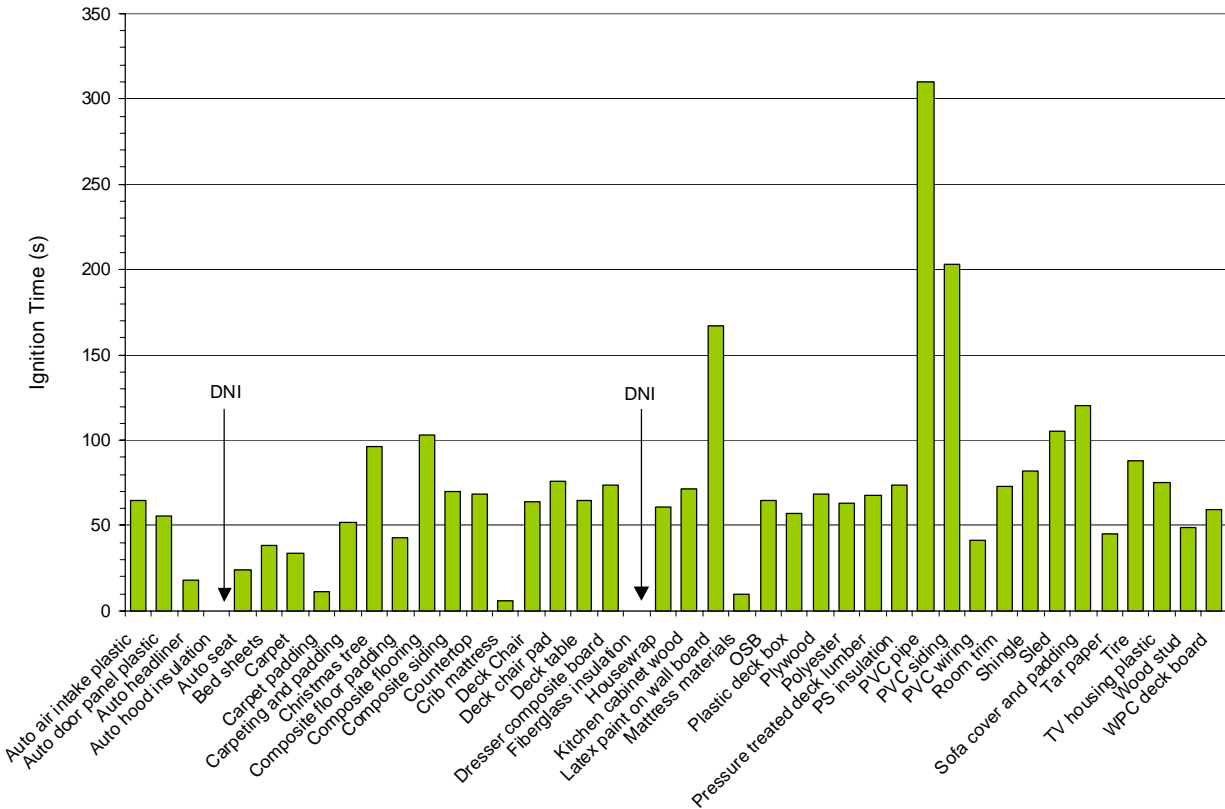
The cone calorimeter combustibility results from the tests included ignition time, sample weight, heat and smoke release rates, effective heat of combustion, and specific extinction area. Combustibility data for the tests are summarized in Table 3-2.

Table 3-2: ASTM E1354 combustibility data for material-level samples.

| Sample                       | Initial Weight (g) | Weight Loss Fraction (%) | Ignition Time (s) | Eff. HOC (kJ/g) | Peak HRR (kW/m <sup>2</sup> ) | Peak SRR (m <sup>2</sup> /s) | Specific Ext. Area (m <sup>2</sup> /g) | Smoke yield |
|------------------------------|--------------------|--------------------------|-------------------|-----------------|-------------------------------|------------------------------|--|-------------|
| Auto air intake plastic      | 26.41              | 100.0                    | 65                | 25.26           | 492.3                         | 0.1662                       | 0.642                                  | 0.076       |
| Auto door panel plastic      | 19.96              | 86.0                     | 55                | 35.85           | 596.3                         | 0.0801                       | 0.374                                  | 0.044       |
| Auto headliner               | 8.31               | 83.5                     | 18                | 26.70           | 316.7                         | 0.0843                       | 0.371                                  | 0.044       |
| Auto hood insulation         | 5.59               | 78.4                     | DNI               | 4.39            | 23.2                          | 0.0181                       | 0.225                                  | 0.026       |
| Auto seat                    | 18.57              | 100.0                    | 24                | 18.58           | 247.7                         | 0.1167                       | 0.343                                  | 0.040       |
| Bed sheets                   | 11.44              | 100.0                    | 39                | 17.38           | 300.8                         | 0.0659                       | 0.175                                  | 0.021       |
| Carpet                       | 13.52              | 60.3                     | 34                | 33.10           | 510.0                         | 0.1176                       | 0.614                                  | 0.072       |
| Carpet padding               | 10.25              | 99.4                     | 11                | 21.96           | 421.6                         | 0.0826                       | 0.379                                  | 0.045       |
| Carpeting and padding        | 35.69              | 66.1                     | 52                | 26.02           | 245.5                         | 0.0562                       | 0.330                                  | 0.039       |
| Christmas tree               | 16.90              | 58.4                     | 96                | 8.44            | 106.6                         | 0.1523                       | 0.654                                  | 0.077       |
| Composite floor padding      | 1.62               | 97.9                     | 43                | 27.57           | 189.3                         | 0.0568                       | 0.509                                  | 0.060       |
| Composite flooring           | 75.77              | 82.8                     | 103               | 12.78           | 513.8                         | 0.0288                       | 0.039                                  | 0.005       |
| Composite siding             | 62.02              | 85.8                     | 70                | 15.61           | 305.6                         | 0.0311                       | 0.052                                  | 0.006       |
| Countertop                   | 159.52             | 82.9                     | 68                | 11.41           | 148.1                         | 0.0266                       | 0.026                                  | 0.003       |
| Crib mattress                | 9.31               | 88.1                     | 6                 | 17.42           | 208.9                         | 0.0495                       | 0.245                                  | 0.029       |
| Deck Chair                   | 33.19              | 93.7                     | 64                | 33.44           | 682.9                         | 0.1023                       | 0.351                                  | 0.041       |
| Deck chair pad               | 20.60              | 99.4                     | 76                | 19.38           | 289.6                         | 0.0917                       | 0.410                                  | 0.048       |
| Deck table                   | 34.71              | 83.2                     | 65                | 37.77           | 646.6                         | 0.1053                       | 0.750                                  | 0.088       |
| Dresser composite board      | 138.78             | 88.2                     | 73                | 12.66           | 189.6                         | 0.0177                       | 0.057                                  | 0.007       |
| Fiberglass insulation        | 10.31              | 32.3                     | DNI               | 9.15            | 11.3                          | 0.0008                       | 0.064                                  | 0.008       |
| Housewrap                    | 10.44              | 98.7                     | 61                | 39.69           | 657.6                         | 0.0618                       | 0.329                                  | 0.039       |
| Kitchen cabinet wood         | 90.82              | 79.4                     | 72                | 10.39           | 194.3                         | 0.0269                       | 0.041                                  | 0.005       |
| Latex paint on wall board    | 113.26             | 14.8                     | 167               | 1.73            | 69.0                          | 0.0112                       | 0.031                                  | 0.004       |
| Mattress materials           | 9.61               | 100.0                    | 10                | 26.21           | 277.7                         | 0.0422                       | 0.201                                  | 0.024       |
| OSB                          | 80.23              | 84.6                     | 65                | 14.30           | 286.1                         | 0.0391                       | 0.068                                  | 0.008       |
| Plastic deck box             | 22.95              | 84.2                     | 57                | 32.08           | 605.6                         | 0.0854                       | 0.351                                  | 0.041       |
| Plywood                      | 64.70              | 100.0                    | 68                | 14.66           | 250.1                         | 0.0286                       | 0.073                                  | 0.009       |
| Polyester                    | 8.30               | 100.0                    | 63                | 17.53           | 426.4                         | 0.1175                       | 0.320                                  | 0.038       |
| Pressure treated deck lumber | 139.09             | 90.8                     | 68                | 15.44           | 212.1                         | 0.0207                       | 0.038                                  | 0.004       |
| PS insulation                | 4.69               | 100.0                    | 73                | 34.85           | 234.2                         | 0.1327                       | 1.036                                  | 0.122       |
| PVC pipe                     | 143.94             | 79.2                     | 310               | 6.80            | 160.0                         | 0.1701                       | 0.675                                  | 0.079       |
| PVC siding                   | 33.54              | 80.8                     | 203               | 9.21            | 131.6                         | 0.1663                       | 0.639                                  | 0.075       |
| PVC wiring                   | 94.27              | 28.2                     | 41                | 16.60           | 176.4                         | 0.1158                       | 0.749                                  | 0.088       |
| Room trim                    | 36.62              | 99.8                     | 73                | 30.69           | 639.7                         | 0.3031                       | 1.463                                  | 0.172       |
| Shingle                      | 41.57              | 20.0                     | 82                | 32.42           | 189.2                         | 0.0799                       | 0.707                                  | 0.083       |
| Sled                         | 25.46              | 76.9                     | 105               | 26.76           | 611.8                         | 0.0644                       | 0.242                                  | 0.028       |
| Sofa cover and padding       | 18.94              | 100.0                    | 121               | 15.94           | 294.3                         | 0.0905                       | 0.399                                  | 0.047       |
| Tar paper                    | 16.86              | 95.2                     | 45                | 22.12           | 396.1                         | 0.1423                       | 0.623                                  | 0.073       |
| Tire                         | 141.37             | 56.3                     | 88                | 31.25           | 236.0                         | 0.1210                       | 0.950                                  | 0.112       |
| TV housing plastic           | 39.78              | 100.0                    | 75                | 14.66           | 388.7                         | 0.5292                       | 1.946                                  | 0.229       |
| Wood stud                    | 178.04             | 79.7                     | 49                | 10.51           | 120.8                         | 0.0143                       | 0.033                                  | 0.004       |
| WPC deck board               | 288.51             | 56.8                     | 59                | 22.94           | 253.4                         | 0.0334                       | 0.179                                  | 0.021       |

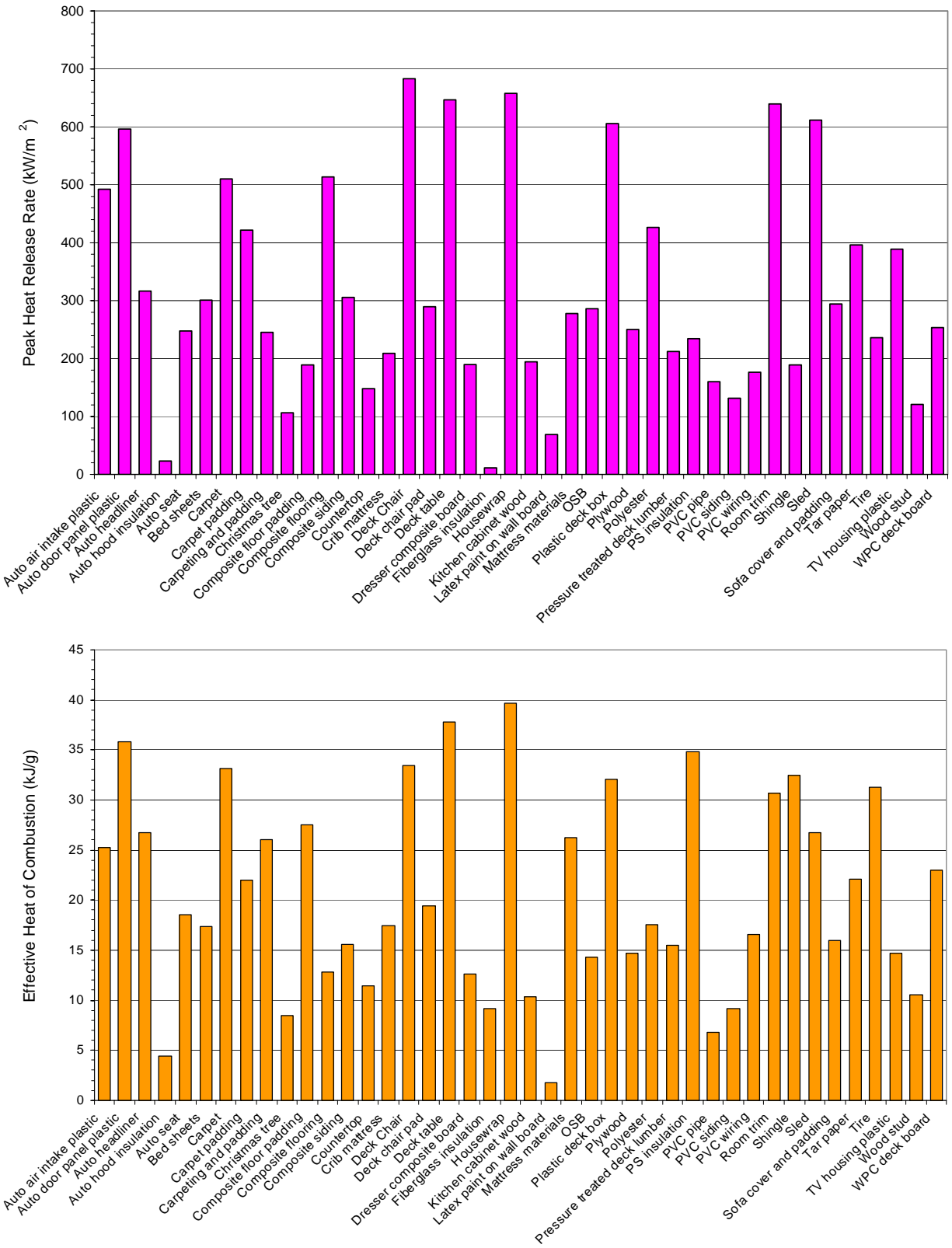
Sample ignition occurred in all tests except for the automobile hood insulation and the fiberglass insulation. Comparison of the time to ignition, plotted in Figure 3-4, indicates that materials with high surface area to volume ratios (e.g. mattress foams) ignited the fastest while non-combustible (e.g. fiberglass) and highly fire retardant (FR) materials (e.g. PVC) took the longest to ignite, if at all.





**Figure 3-4: Time to ignition for material-level test samples.**

Analysis of the heat release rates and an effective inherent heat of combustion, plotted in Figure 3-5, indicate that chemically simple synthetic materials (e.g. polyolefins) have the highest heat release whereas noncombustible or highly FR loaded materials exhibited the lowest heat release. Comparison of the results for the wood stud, plywood, OSB, and wood-plastic composite deck board, indicates that heat release increases with the incorporation of synthetic components such as adhesives for the plywood and OSB board or polyolefin resin for the wood-plastic composite deck board. Materials with higher effective heat of combustion exhibit greater peak heat release rates.



**Figure 3-5: Peak heat release rates (top) and effective heat of combustion (bottom) for material-level test samples.**

Similarly, smoke production during flaming combustion is greater for synthetic materials than that for natural cellulosic products, plotted in Figure 3-6. Material chemistry plays a significant role in the amount of smoke produced such that:

1. Introduction of aromatic groups to simple straight chain hydrocarbons increases smoke production (sled versus styrene based materials).
2. Materials with aromatic molecular groups exhibited the highest smoke production – styrene based materials (PS insulation, room trim, television housing, tire), polyester products (carpet, pillow stuffing, sheet).
3. Substitution of nitrogen and chlorine atoms into the base polymer molecule as well as aromatic additives (nylon carpet, PVC products) also increases smoke production.

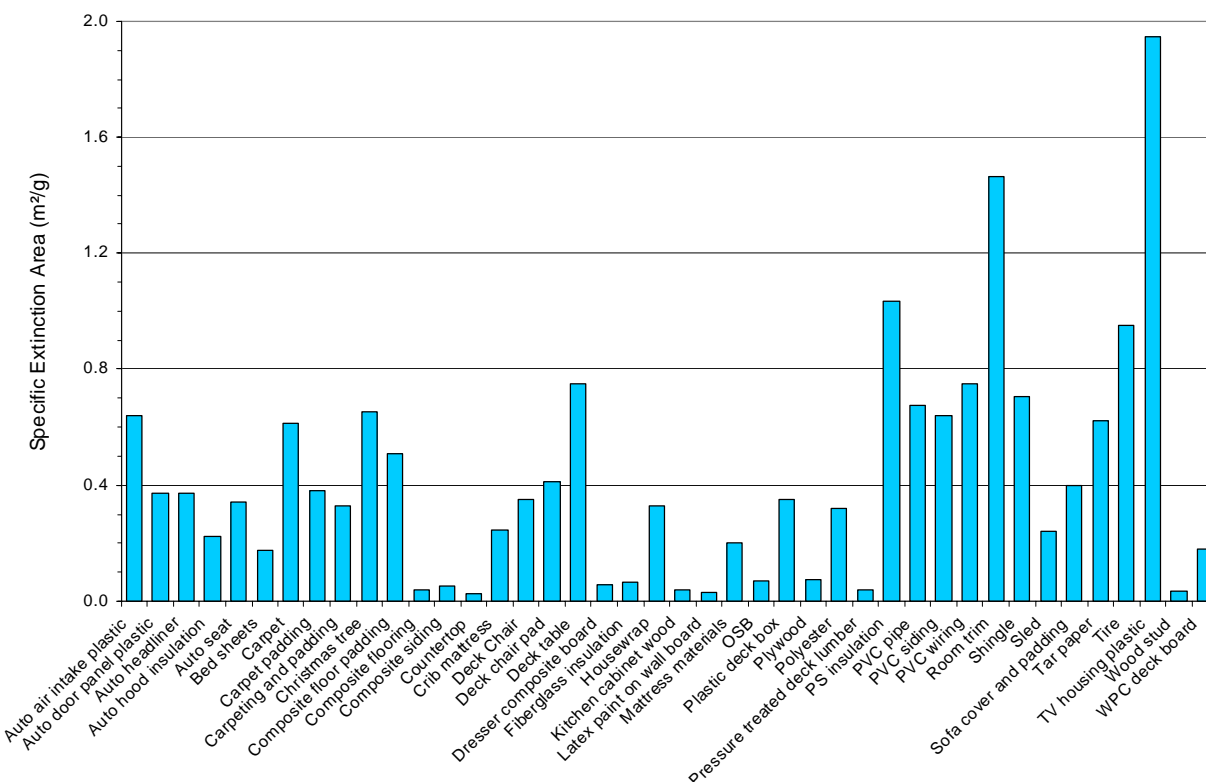


Figure 3-6: Smoke production for material-level test samples.

### 3.2.2 Developed Smoke Particles

The smoke particle size distribution data measured on the WPS spectrometer were analyzed to calculate the mean particle diameter  $D_m$  and count  $N_m$  for each test as described by Eq. 10 and Eq. 11. Mean particle count was further corrected to compensate for weight loss differences between the evaluated materials as described in Eq. 17.

$$\text{Specific } N_m = N_m / \text{weight loss [=]} \text{ cm}^{-3} \cdot \text{g}^{-1} \tag{Eq. 17}$$

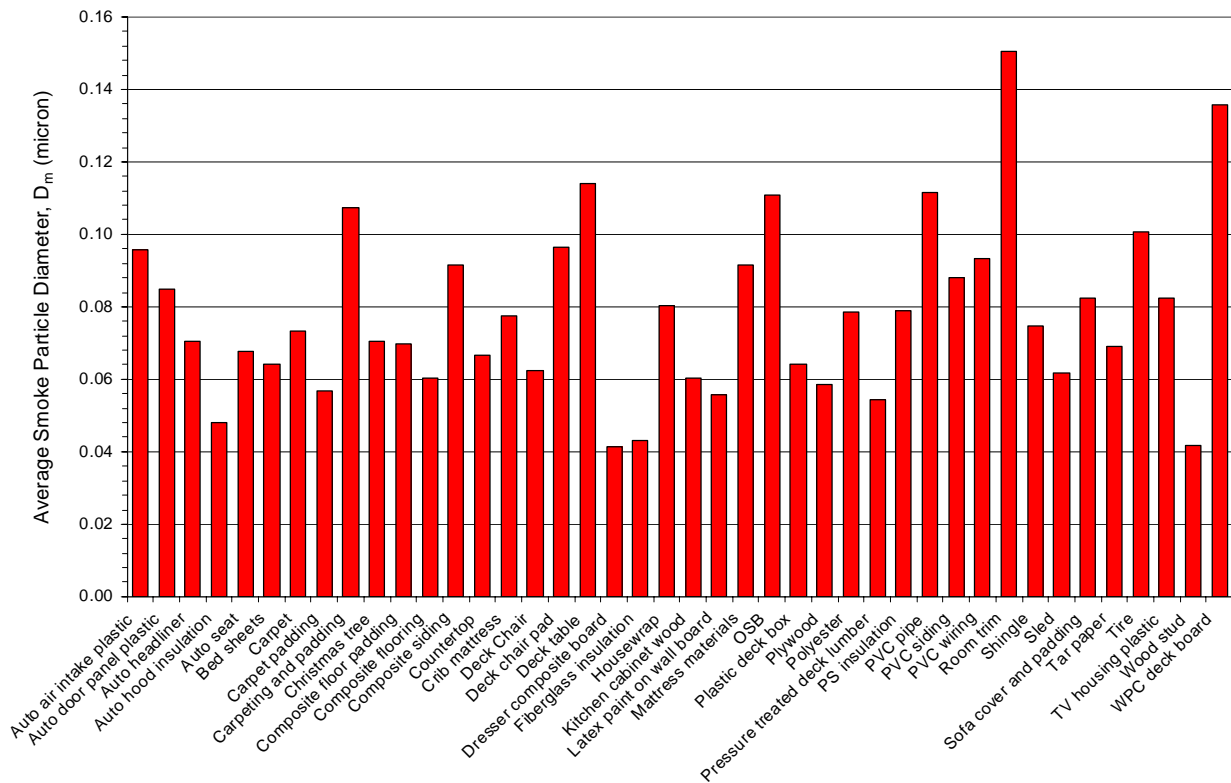
Maximum and mean smoke particle size, mean and specific mean particle counts are summarized in Table 3-3.

Table 3-3: Smoke particle data for material-level test samples.

| Sample                       | Max. Particle Diameter (micron) | Average Diameter, $D_m$ (micron) | Average Number, $N_m$ ( $cm^{-3}$ ) | Specific Number, $N_m$ ( $cm^{-3} g^{-1}$ ) |
|------------------------------|---------------------------------|----------------------------------|-------------------------------------|---|
| Auto air intake plastic      | 0.203                           | 0.096                            | 4.27E+06                            | 1.63E+05                                    |
| Auto door panel plastic      | 0.228                           | 0.085                            | 3.59E+06                            | 2.14E+05                                    |
| Auto headliner               | 0.193                           | 0.070                            | 5.25E+06                            | 7.58E+05                                    |
| Auto hood insulation         | 0.107                           | 0.048                            | 1.18E+06                            | 2.80E+05                                    |
| Auto seat                    | 0.233                           | 0.068                            | 5.78E+06                            | 3.09E+05                                    |
| Bed sheets                   | 0.191                           | 0.064                            | 3.24E+06                            | 2.83E+05                                    |
| Carpet                       | 0.234                           | 0.073                            | 2.52E+06                            | 3.10E+05                                    |
| Carpet padding               | 0.152                           | 0.057                            | 6.47E+06                            | 6.35E+05                                    |
| Carpeting and padding        | 0.220                           | 0.107                            | 3.74E+06                            | 1.59E+05                                    |
| Christmas tree               | 0.118                           | 0.070                            | 4.86E+06                            | 4.94E+05                                    |
| Composite floor padding      | 0.161                           | 0.070                            | 3.31E+06                            | 1.62E+06                                    |
| Composite flooring           | 0.210                           | 0.060                            | 5.08E+06                            | 8.09E+04                                    |
| Composite siding             | 0.224                           | 0.092                            | 3.08E+06                            | 5.86E+04                                    |
| Countertop                   | 0.252                           | 0.067                            | 3.84E+06                            | 2.90E+04                                    |
| Crib mattress                | 0.191                           | 0.078                            | 3.59E+06                            | 4.38E+05                                    |
| Deck Chair                   | 0.229                           | 0.062                            | 3.80E+06                            | 1.23E+05                                    |
| Deck chair pad               | 0.216                           | 0.096                            | 3.55E+06                            | 1.75E+05                                    |
| Deck table                   | 0.224                           | 0.114                            | 2.91E+06                            | 1.01E+05                                    |
| Dresser composite board      | 0.198                           | 0.041                            | 3.93E+06                            | 3.18E+04                                    |
| Fiberglass insulation        | 0.098                           | 0.043                            | 6.88E+05                            | 2.09E+05                                    |
| Housewrap                    | 0.228                           | 0.080                            | 4.02E+06                            | 3.91E+05                                    |
| Kitchen cabinet wood         | 0.209                           | 0.060                            | 6.33E+06                            | 8.89E+04                                    |
| Latex paint on wall board    | 0.149                           | 0.056                            | 4.83E+06                            | 2.88E+05                                    |
| Mattress materials           | 0.205                           | 0.091                            | 2.76E+06                            | 2.87E+05                                    |
| OSB                          | 0.225                           | 0.111                            | 2.26E+06                            | 3.34E+04                                    |
| Plastic deck box             | 0.219                           | 0.064                            | 3.90E+06                            | 1.99E+05                                    |
| Plywood                      | 0.210                           | 0.059                            | 2.34E+06                            | 3.64E+04                                    |
| Polyester                    | 0.157                           | 0.079                            | 3.45E+06                            | 4.15E+05                                    |
| Pressure treated deck lumber | 0.230                           | 0.054                            | 3.60E+06                            | 2.89E+04                                    |
| PS insulation                | 0.183                           | 0.079                            | 2.20E+06                            | 4.70E+05                                    |
| PVC pipe                     | 0.197                           | 0.112                            | 4.05E+06                            | 3.56E+04                                    |
| PVC siding                   | 0.253                           | 0.088                            | 3.44E+06                            | 1.27E+05                                    |
| PVC wiring                   | 0.230                           | 0.093                            | 5.39E+06                            | 2.03E+05                                    |
| Room trim                    | 0.246                           | 0.150                            | 2.81E+06                            | 7.69E+04                                    |
| Shingle                      | 0.199                           | 0.075                            | 4.22E+06                            | 5.03E+05                                    |
| Sled                         | 0.227                           | 0.062                            | 5.68E+06                            | 2.97E+05                                    |
| Sofa cover and padding       | 0.172                           | 0.082                            | 5.60E+06                            | 2.96E+05                                    |
| Tar paper                    | 0.193                           | 0.069                            | 4.70E+06                            | 2.93E+05                                    |
| Tire                         | 0.224                           | 0.101                            | 5.51E+06                            | 6.91E+04                                    |
| TV housing plastic           | 0.194                           | 0.082                            | 4.91E+06                            | 1.23E+05                                    |
| Wood stud                    | 0.169                           | 0.042                            | 7.36E+06                            | 5.22E+04                                    |
| WPC deck board               | 0.223                           | 0.136                            | 3.69E+06                            | 2.24E+04                                    |

The average smoke particle sizes and specific particle number densities for the evaluated materials are plotted in Figure 3-7 and Figure 3-8. Smokes generated by resin based materials such as the room trim, deck table, wood-plastic composite deck board, and tire have the largest mean sizes whereas the natural cellulosic materials (wood stud) and noncombustible insulations

materials have the smallest. It was observed that materials generating larger smoke particles tend also to have larger specific extinction areas, Figure 3-6.



**Figure 3-7: Average smoke particle diameter  $D_m$  for material-level test samples.**

Specific smoke particle counts indicate that the materials with the highest surface area to sample volume ratios (foam materials, insulation, polyester fill) tend to generate more particles per consumed mass than the other evaluated materials. The solid wood based materials (wood-plastic composite deck board, OSB, plywood, dresser composite board) and PVC pipe were the least prolific sources of smoke particles.

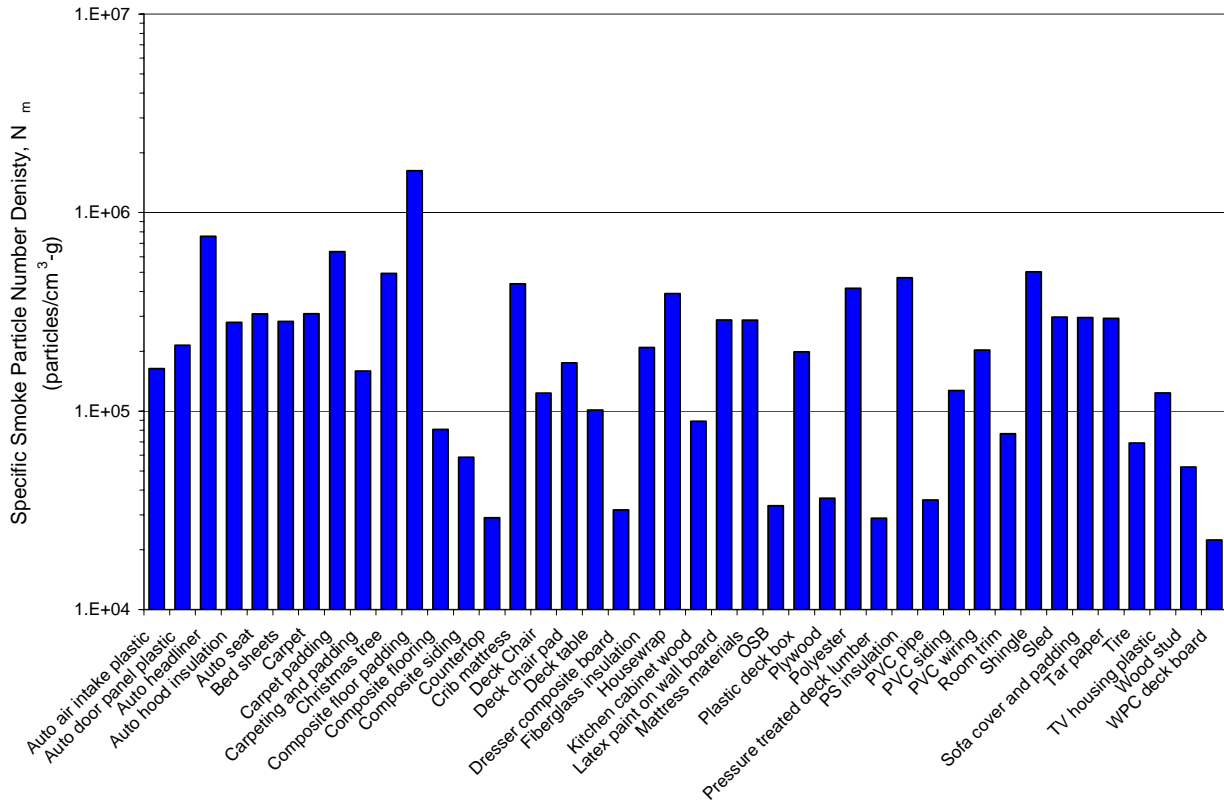


Figure 3-8: Specific smoke particle number density  $N_m$  for material-level test samples.

Comparison of the specific smoke particle number densities to the average smoke particle sizes, Figure 3-9, reveals a semi-log relationship. Analysis of the data indicates that for the materials other than the wood-based materials (countertop, plywood, pressure treated deck lumber, dresser composite board, and wood stud), the relationship between the specific smoke particle number density and average particle size is approximately  $5 \times 10^{13}$  particles produced per gram of material consumed while the wood based materials correspond to approximately  $4 \times 10^{12}$  particles produced per gram of material consumed.

$$\text{wood-based materials: } (\text{Specific } N_m) \times \left(\frac{4}{3}\right) \pi \left(\frac{D_m}{2}\right)^3 \approx 4 \times 10^{12} \text{ particles/g consumed material}$$

$$\text{other materials: } (\text{Specific } N_m) \times \left(\frac{4}{3}\right) \pi \left(\frac{D_m}{2}\right)^3 \approx 5 \times 10^{13} \text{ particles/g consumed material}$$

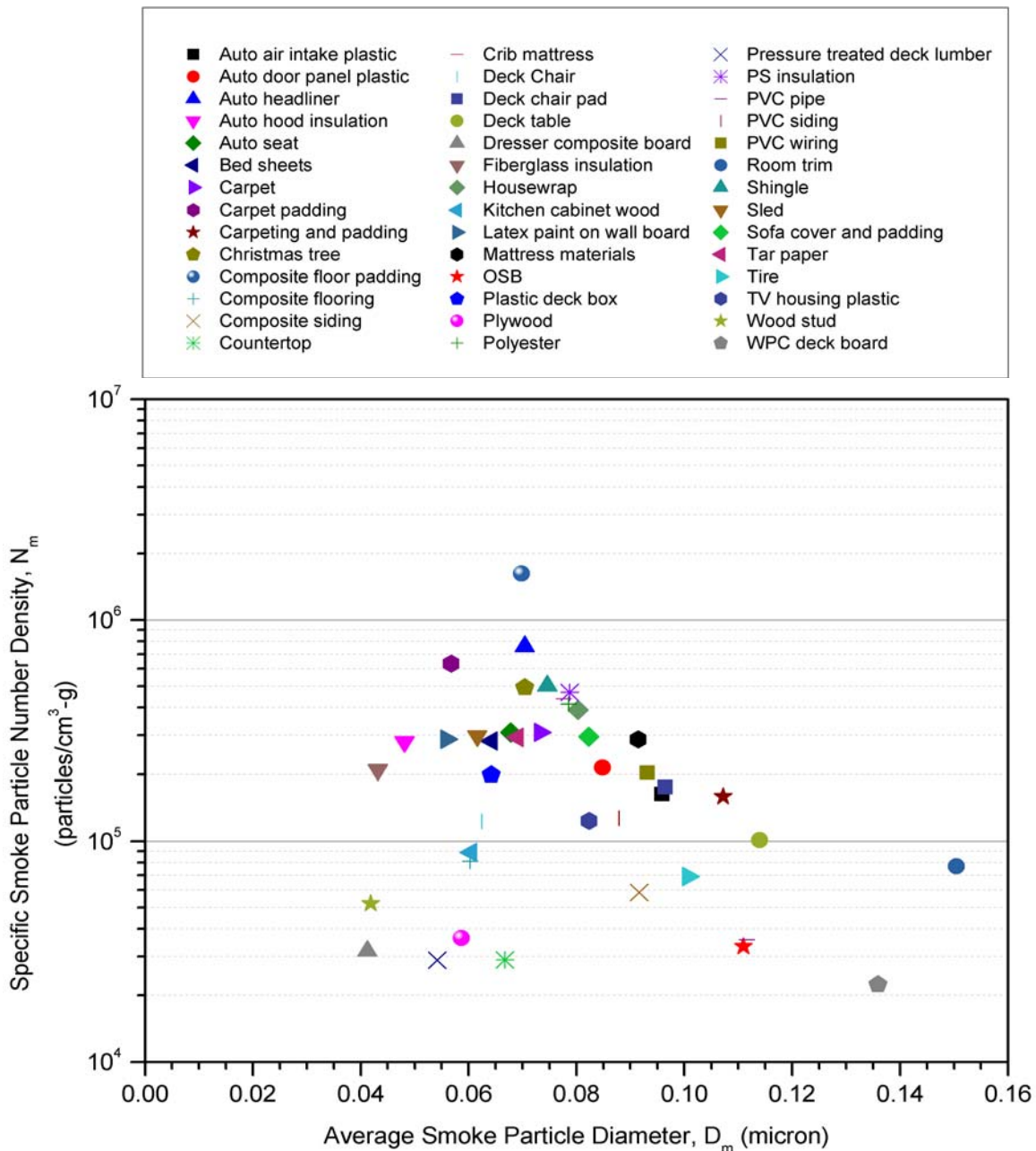


Figure 3-9: Specific smoke number density versus average particle size for material-level test samples.

### 3.2.3 Effluent Gas Composition

Effluent gas analysis indicates water, carbon dioxide, and carbon monoxide are the predominant species, and other gases to a lesser extent, Table 3-4. This is consistent with the chemical reaction for hydrocarbon combustion. Average carbon dioxide and carbon monoxide yields for the different materials are plotted in Figure 3-10. Carbon dioxide yield generally ranged between 1 to 3.5g/g for the various materials; styrene based materials and low density materials exhibited the highest CO<sub>2</sub> yields in excess of 3 g/g. Carbon monoxide yield was generally less than 0.4 g/g. Noncombustible and high FR materials exhibited the smallest CO<sub>2</sub> to CO yield ratio, Figure 3-11.

**Table 3-4: Effluent gases detected in combustion of material-level test samples.**

| Sample                       | CO <sub>2</sub> Yield | CO Yield | Other Detected Gases (in decreasing yield order) <sup>[1]</sup>                                |
|------------------------------|-----------------------|----------|--|
| Auto air intake plastic      | 2.552                 | 0.227    | Acetylene, HCN, Methane, Ethylene  |
| Auto door panel plastic      | 2.979                 | 0.156    | Ammonia, Acetylene, Methane, Ethylene, HCN, <i>2,3-Dimethyl-1-hexene</i>                       |
| Auto headliner               | 2.894                 | 0.289    | Pentanol, Acetylene, HCN, Ethylene   |
| Auto hood insulation         | 1.185                 | 0.443    | <b>HCN</b> , Formaldehyde, Methane, Ethylene, Phenol   |
| Auto seat                    | 2.164                 | 0.273    | <b>Acetylene</b> , HCl, HCN, Methane, Ethylene, Phenol   |
| Bed sheets                   | 2.586                 | 0.368    | Formaldehyde, Ethylene, Methane, <i>Phenyl isocyanate</i>                                      |
| Carpet                       | 3.022                 | 0.164    | Acetylene, Pentanol, Ethylene  |
| Carpet padding               | 2.310                 | 0.317    | <b>HCN</b> , Acetylene, HCl, Ammonia, Formaldehyde, Ethylene, <i>Isocyanic acid</i>            |
| Carpeting and padding        | 2.744                 | 0.223    | Acetylene, Ammonia, Methane, Ethylene  |
| Christmas tree               | 0.785                 | 0.313    | <b>HCl, Benzene, Methanol</b> , Acetylene, Methane, Phenol, Ethylene                           |
| Composite floor padding      | 3.020                 | 0.333    | <b>Styrene</b> , Methanol, Acetylene, Phenol, Ethylene, HCN                                    |
| Composite flooring           | 1.635                 | 0.119    | Ammonia, Methane, HCN, Methanol, Formaldehyde  |
| Composite siding             | 2.037                 | 0.246    | Methane, Ammonia, HCN, Propane, Methanol, Ethylene, Phenol                                     |
| Countertop                   | 1.844                 | 0.117    | Methane, Ammonia, HCl, Formaldehyde, Methanol, HCN, Ethylene, Phenol                           |
| Crib mattress                | 1.995                 | 0.515    | <b>HCl</b> , HCN, Acetylene, Methane, Ethylene   |
| Deck Chair                   | 2.911                 | 0.214    | <b>Propanol</b> , Ammonia, Acetylene, Ethylene   |
| Deck chair pad               | 2.497                 | 0.335    | Acetylene, Acetic Acid, HCN, HCl, Methane, Ethylene  |
| Deck table                   | 3.083                 | 0.140    | Acetylene, Ethylene, <i>Acetone, 2,3-Dimethyl-1-hexene</i>                                     |
| Dresser composite board      | 1.908                 | 0.194    | Methane, Ammonia, Methanol, Formaldehyde, Ethylene, HCN, Phenol, <i>Isocyanic acid</i>         |
| Fiberglass insulation        | 0.428                 | 0.437    | <b>Ammonia, Formaldehyde</b> , Ethylene, Acetylene, Methane, <i>Isocyanic acid, Octanol</i>    |
| Housewrap                    | 3.126                 | 0.153    | Acetylene, Formaldehyde, Ethylene, Acrylonitrile   |
| Kitchen cabinet wood         | 1.894                 | 0.107    | Methane, Ammonia, Formaldehyde, Methanol, HCl, Ethylene, HCN, Phenol, <i>Phenyl isocyanate</i> |
| Latex paint on wall board    | 0.199                 | 0.111    | Methanol, Formaldehyde, Phenol, Ethylene   |
| Mattress materials           | 3.116                 | 0.165    | Acetylene, Formaldehyde, HCN, Ethylene, Methane  |
| OSB                          | 1.926                 | 0.144    | Methane, Ammonia, Formaldehyde, Methanol   |
| Plastic deck box             | 2.828                 | 0.212    | <b>Pentanol</b> , Acetylene, Ethylene  |
| Plywood                      | 2.155                 | 0.340    | Formic Acid, Methane, Ammonia, Formaldehyde, Methanol, Phenol, Ethylene                        |
| Polyester                    | 2.434                 | 0.572    | Acetylene, Formaldehyde, Ethylene, Methane, HCN, Phenol  |
| Pressure treated deck lumber | 1.965                 | 0.146    | Methane, Formaldehyde, Methanol, Ethylene, Phenol  |
| PS insulation                | 3.701                 | 0.245    | <b>Styrene, CFC-142</b> , Acetylene, Ethylene, HCN   |
| PVC pipe                     | 0.722                 | 0.154    | <b>HCl, Benzene, Acetylene</b> , Methane, Ethylene, HBr  |
| PVC siding                   | 0.994                 | 0.208    | <b>HCl, Benzene, Methanol, Acetylene</b> , Methane, Ethylene                                   |
| PVC wiring                   | 1.747                 | 0.252    | <b>HCl, Acetylene, Benzene</b> , Methane, Ethylene, HCN, <i>2-propyl-1-pentanol</i>            |
| Room trim                    | 2.531                 | 0.132    | <b>Styrene, Acetylene</b> , Ethylene   |
| Shingle                      | 3.420                 | 0.535    | <b>Ammonia</b> , Acetylene, Methane, Ethylene  |
| Sled                         | 2.426                 | 0.232    | Formaldehyde, Ethylene, Acetylene, <i>Octanol</i>  |
| Sofa cover and padding       | 2.139                 | 0.481    | <b>Toluene Diisocyanate</b> , HCN, Acetylene, Methanol, Methane, Ethylene, Phenol              |
| Tar paper                    | 2.588                 | 0.394    | <b>SO<sub>2</sub></b> , Acetylene, Ammonia, Methane, Ethylene, Formaldehyde, Methanol, Phenol  |
| Tire                         | 3.553                 | 0.492    | <b>Acetonitrile, SO<sub>2</sub>, Acetylene</b> , Methane, Ethylene                             |
| TV housing plastic           | 1.205                 | 0.259    | <b>Styrene, Acetylene, Benzene, HBr</b> , Methane, Ethylene, HCl, HCN                          |
| Wood stud                    | 1.704                 | 0.164    | Methane, Formaldehyde, Methanol, Ethylene, Phenol  |
| WPC deck board               | 2.694                 | 0.050    | Formic Acid, Formaldehyde, Methanol, Ethylene, Acetic Acid                                     |

Note: <sup>[1]</sup> Gases with yields greater than 0.01 g Gas produced per g Consumed material are in **bold**; Gases in *italics* were detected but no reference concentration existed for quantification.



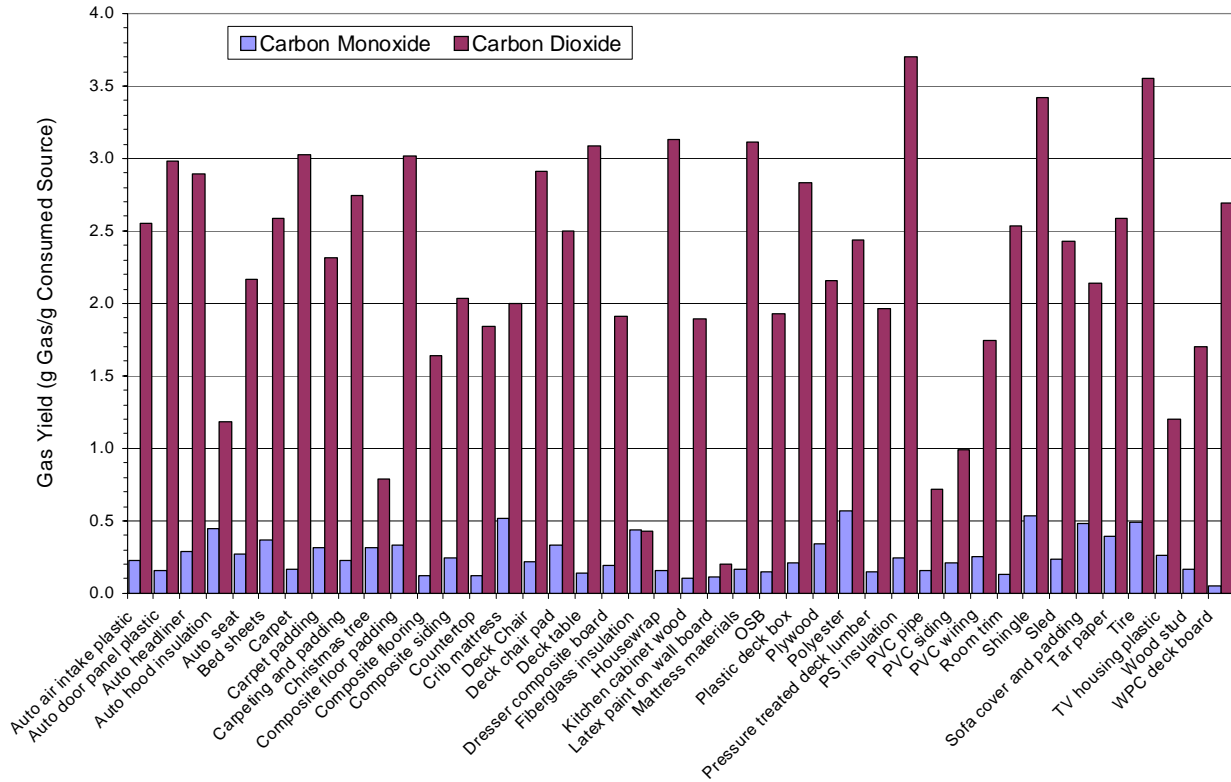


Figure 3-10: Carbon dioxide and monoxide yields for material-level test samples.

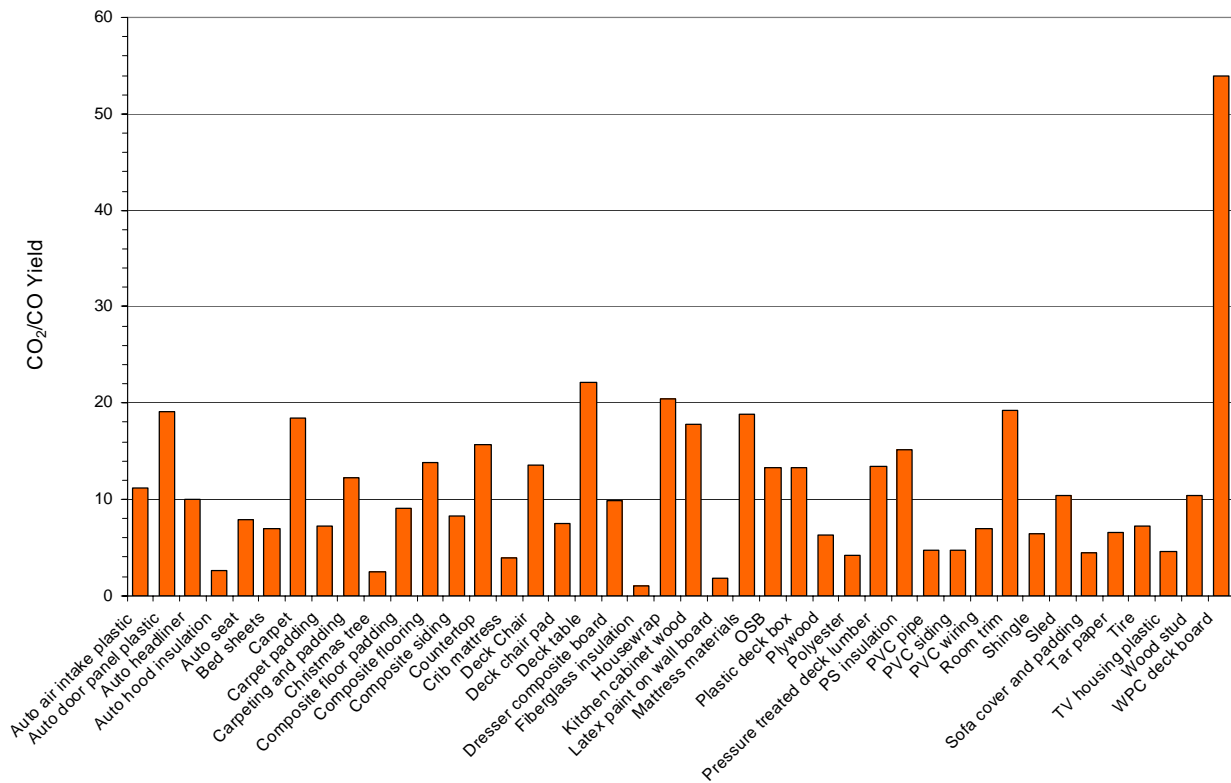


Figure 3-11: Carbon dioxide to carbon monoxide yield ratio for material-level test samples.

## CHAPTER 4: LARGE-SCALE EXPERIMENTAL TESTS

### 4.0 INTRODUCTION

Real-scale laboratory fire tests were conducted in Underwriters Laboratories' large-scale fire test laboratory to collect and analyze the gas effluents, smoke particulates, and condensed residues produced under controlled, repeatable laboratory conditions. These laboratory tests served as a platform to develop and refine the sampling techniques that would be implemented in the field portions of the study (Chapters 5 and 6).

### 4.1 FIRE EVENTS

Nine fire test scenarios were developed, focusing on residential building and automobile scenarios:

1. Residential living room
2. Residential living room (limited ventilation, smoldering fire)
3. Residential bedroom
4. Residential kitchen
5. Residential attic (ventilated roof)
6. Residential wood deck
7. Residential composite deck
8. Automobile passenger compartment fire
9. Automobile engine compartment fire

For the residential room scenarios, structures were designed and built that represented typical residential construction building practices. The structures were each approximately 12' by 14' in size and possessed windows, doors, etc. Each of the room scenarios contained traditional furnishings common to the specific scenario. For example, the kitchen was outfitted with traditional wood cabinets, countertops, appliances, wood table and chairs. The attic scenario featured a typical residential roof structure. The deck structures were constructed of traditional sized lumber members and attached to a residential building wall.

The automobiles utilized in these tests were four-door passenger cars. A passenger compartment fire and an engine compartment fire were conducted. The fires were started using a small open flame ignition source in the respective compartment and were allowed to penetrate and propagate into the adjoining compartment.

Each of the fire tests differed slightly, but they all possessed a fire growth, suppression, and overhaul stage. Several measurements were taken during the different stages of the fire tests. An emphasis was placed on smoke measurements, however other standard instrumentation was implemented to provide a context for the acquired test results.

The gas effluents that were generated and present during the fire test were measured using an extractive gas FTIR and an open path gas FTIR analyzer (OP-FTIR). A particle analyzer was used to determine the quantity and size distribution of the smoke particulates that were present. Commercially available ionization and photoelectric smoke alarms and a carbon monoxide detector were placed in the residential home scenarios. In addition, the heat release rate (HRR)

and smoke release rate (SRR) were measured for each of the scenarios using a large-scale product calorimeter.

While the fire fighters conducted overhaul activities, they wore personal particle impactors and gas monitors to collect and monitor the personal exposure levels of smoke.

#### **4.1.1 Living Room**

The living room fire scenario represented a living room fire caused by a small open flame, such as a candle, igniting upholstered furniture. From 2003 to 2006 2% of the home structure fires began with upholstered furniture but these fires accounted for 21% of the home fire deaths and 7% of the home fire injuries.<sup>1</sup>

##### **Room Construction**

A 12×14 ft (3.7×4.3 m) room with an 8 ft (2.4 m) ceiling was constructed for the living room. The base of the room was a box joist assembly measuring 12×14 ft (3.7×4.3 m) constructed using nominal 2×4 in. (5×10 cm) structural grade lumber. Joists were fastened every 16 in. (41 cm) OC perpendicular to the 14 ft (4.3 m) rails with two No. 16d nails or equivalent means. The base was placed on the concrete floor of the test cell and covered with nominal 3/4 in. (2 cm) T&G plywood or OSB the sub-floor panels. Sub-floor panels were installed perpendicular to the joists using a 1/4 in. (0.6 cm) bead of adhesive and fastened every 6 in. (15 cm) OC at the perimeter and 12 in. (30 cm) OC in the field with 8d nails or equivalent.

Eight foot (2.4 m) tall walls were constructed using traditional 2×4 in. (5×10 cm) structural grade lumber construction with studs spaced 16 in. (41 cm) OC. Walls were fastened to the floor with No. 16d nails or equivalent means. Faced 3 1/2 in. (9 cm) R-12 insulation was placed between joists and studs. The exterior of the structure was clad with nominal 1/2 in. (1.3 cm) OSB sheathing. One wall (short side) had a 30×36 in. (76×91 cm) double hung window and a US standard 80 in. (2 m) tall, 32 in. (0.8 m) wide door as indicated in Figure 4-2.

The room top was constructed using TJI engineered rafters perpendicularly attached to the 12 ft (3.7 m) walls, spaced 16 in. (41 cm) OC, and fastened at each end to the top plate with No. 16d nails or equivalent means. Un-faced 12 in. (30 cm) R-38 insulation was placed between joists and studs.

The interior of the room frame was lined with gypsum board, 1/2 in. (1.3 cm) thick for the walls and 5/8 in. (1.6 cm) for the ceiling, taped and joint compounded at all seams, and painted with white latex paint. The living room floor consisted of carpeting over carpet padding such that the carpeting was secured to the floor using nailing strips installed around the perimeter of the room.

CAD drawings of the structure can be found in Appendix B.

---

<sup>1</sup> M Ahrens, "Home Structure Fires", National Fire Protection Association, 1 Batterymarch Park, Quincy, MA 02169-7471, January 2009.

### **Furnishings**

The living room was furnished with items normally found in a living room setting such as a sofa, love seat, end table, coffee table, TV stand, flat screen TV, carpeting & pad, lamp with light bulb. Figure 4-1 shows the living room scenario with the furnishings. Before and after fire test photos of additional furnishings can be found in Appendix C.

### **Instrumentation**

The living room fire scenario was instrumented with several pieces of equipment to characterize heat, smoke, and gas evolution during the course of the test. Figure 4-2 shows a schematic diagram of the living room with the location of the instrument sampling points.

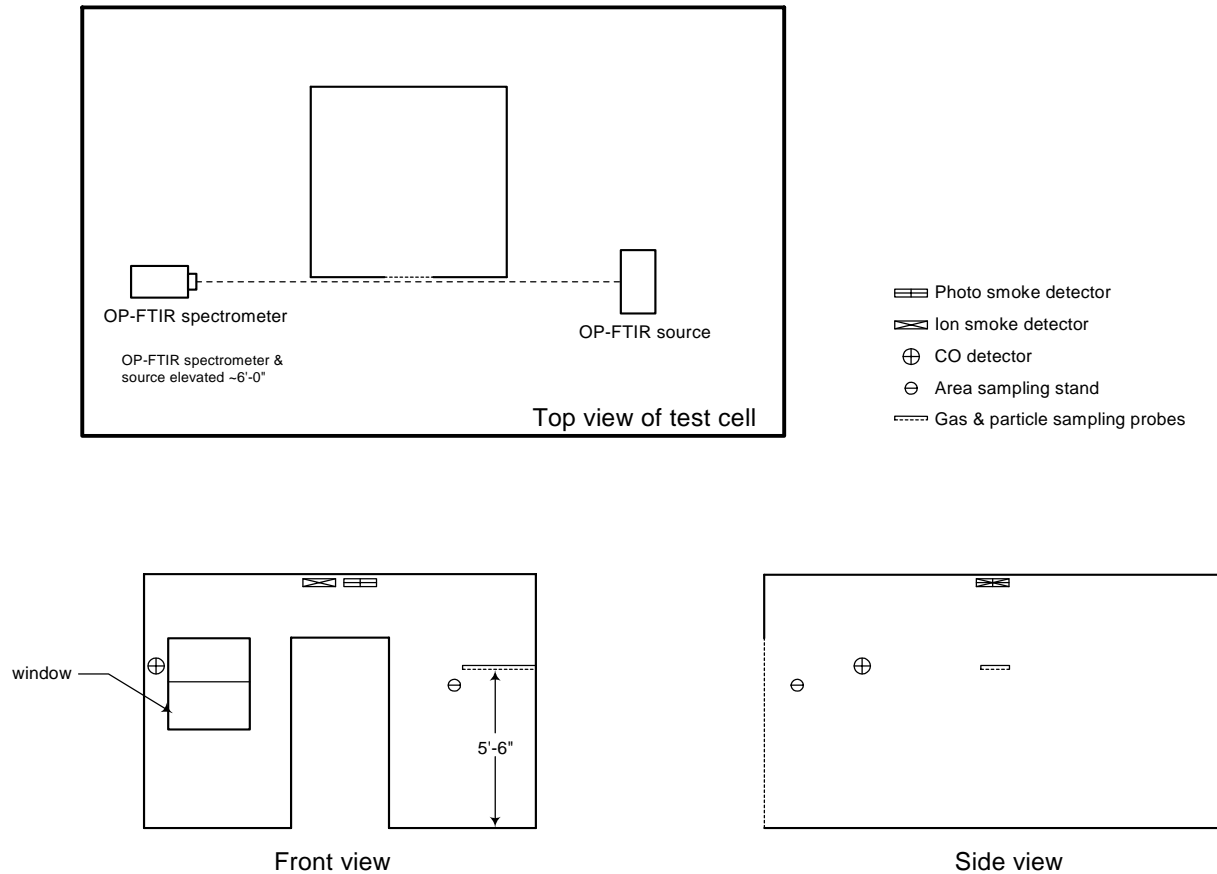
The OP-FTIR was operated in active mode. The spectrometer and IR source were positioned such that the beam path was along the front wall approximately 6 in. (15 cm) out and 2 in. (5 cm) below the top of the doorway. An optical path length corresponding to the emitted smoke plume of 2.8 m was used for gas concentration calculations.

Stainless steel sampling probes for the extractive gas and smoke particle analyzers were positioned at standing face height, nominal 5 ft 6 in. (1.68 m), at the lateral midpoint of the right room wall. The sampling probes were 9.5 mm in diameter with 5 holes spaced at 12.5 cm intervals and extended 79 cm into the room.

Area gas sampling stands were positioned in the room (post-suppression) along the wall near the extractive FTIR and particle analyzer sampling probes such that gas sampling was 4 ft (1.2 m) above the floor.



**Figure 4-1: Photograph of the furnished living room interior. Note the gas and particle sampling probe extending into the right side of the room at standing face level.**



**Figure 4-2: Schematic diagram showing the instrumentation placement for the living room scenario**

**Test Sequence**

The living room fire was initiated with a candle flame. The candle was positioned between the arm/set cushion and bottom couch cushion of the sofa against the far wall.

Prior to starting the test, a volumetric flow rate of 60,000 cfm (1,700 m<sup>3</sup>/min) was established through the test facility calorimeter exhaust duct. Baseline (i.e. background) measurements for the OP-FTIR, extractive FTIR, and smoke particle counter were collected for 3 minutes immediately prior to candle ignition. Ambient temperature and relative humidity were also recorded.

The fire was allowed to grow to flashover and for an additional minute beyond flashover so as to engage all of the furnishings. Water was manually applied in approximately 3 second bursts to suppress the flames, but still allow the furnishings to continue burning. This water application process (informally termed, *teasing* the fire) was repeated if flashover reoccurred.

After 4 minutes of teasing the fire, the fire was fully suppressed. After suppression, overhaul procedures were conducted for 30 minutes by two firefighters. The firefighters were outfitted with personal gas and particle sampling devices. In addition, the firefighters placed area gas sampling stands in the room to monitor the specific gas concentrations present during the

overhaul activities. The extractive FTIR and smoke particle analyzer were initiated at the beginning of the overhaul activities.

All recording devices were terminated 3 minutes after completion of the 30-minute overhaul sequence.

#### **4.1.2 Living Room – Limited Ventilation**

This fire scenario represents a variation of the previously described living room fire scenario except the room door was opened and closed as needed to restrict air flow to the room. Consequently the reduced oxygen limited for fire growth and resulted in an under-ventilated, smoldering fire. The amount of furnishings in the room was also increased to better represent typical living rooms.

##### **Room Construction**

The limited ventilation living room structure possessed the same dimensions and was constructed using the same materials and practices as the previously described living room fire scenario. Whereas the living room fire structure had only a door opening, the limited ventilation living room structure had a 6 panel, wood interior door. Also the flooring for the limited ventilation scenario consisted of Pergo® engineered wood flooring floated over foam instead of the carpeting used in the living room fire scenario. CAD drawings of the structure can be found in Appendix B.

##### **Furnishings**

The limited ventilation living room was furnished with items similar to the living room setting: sofa, love seat, end table, coffee table, TV stand, flat screen TV, carpeting & pad, lamp with light bulb. Additional furnishings included ceiling can lights, crown molding, throw rug, an electric slot-car racing set on the coffee table, a plastic rocking horse, blankets draped over one of the sofa arms, cigarettes, plastic cups, color magazines, desk, computer with CRT monitor, and a plastic plant in the room corner. Figure 4-3 shows the living room scenario with the furnishings. Before and after fire test photos of additional furnishings can be found in Appendix C.

##### **Instrumentation**

The limited ventilation living room fire scenario was instrumented with several pieces of equipment to characterize heat, smoke, and gas evolution during the course of the test.

The OP-FTIR was operated in active mode. The spectrometer and IR source were positioned such that the beam path was along the front wall approximately 13.5 in. (34cm) out and 18 in. (46 cm) above the top of the doorway. An optical path length corresponding to the emitted smoke plume of 3.0 m was used for gas concentration calculations.

Sampling probes for the extractive gas and smoke particle analyzers were positioned at standing face height, nominal 5 ft 6 in. (1.68 m), at the lateral midpoint of the right room wall. The sampling probes were 9.5 mm in diameter with 5 holes spaced at 12.5 cm intervals and extended 79 cm into the room.

The sampling port for the bench-top cascade impactor was positioned to draw 100 Lpm from 6 ft. 4 in. (1.9 m) above the floor and 5 in. (13 cm) to the right of the door.

Area gas sampling stands were positioned in the front right corner of the room such that gas sampling was 4 ft (1.2 m) above the floor.



**Figure 4-3: Photograph of the furnished living room interior for the limited ventilation fire test. Note the thermocouple instrumented post in the center of the room.**

### Test Sequence

The limited ventilation living room fire was initiated similarly to the previously described living room fire (candle positioned between the arm/set cushion and back cushion of the sofa on the far side of the room).

Prior to starting the test, a volumetric flow rate of 60,000 cfm (1,700 m<sup>3</sup>/min) was established through the test facility calorimeter exhaust duct. Baseline (i.e. background) measurements for the OP-FTIR, extractive FTIR, and smoke particle counter were collected for 3 minutes immediately prior to candle ignition. OP-FTIR measurements were continued throughout the test. Extractive FTIR and smoke particle measurement continued until room conditions (e.g. smoke concentration, temperature) compromised measurement capability. Ambient temperature and relative humidity were also recorded.

The bench-top cascade impactor and an area gas sampling stand were initiated at the time of ignition. The area gas sampling stand was operated until the temperature surrounding the sampling port exceeded 115°F (46°C), after which it was removed. The cascade impactor was operated until suppression commenced.

Following ignition, the fire was allowed to propagate from the couch to other areas of the room. In order to prevent large flames extending from the doorway, the ventilation was limited using a wooden door. Throughout the experiment, the door was opened and closed to allow the fire to either grow or diminish. After approximately 25 minutes, the fire was allowed to continue

through flashover (i.e. flames extend from doorway). After flashover, the fire was fully suppressed and overhaul activities were conducted for 30 minutes by two firefighters.

The two firefighters were outfitted with personal gas and particle sampling devices. Following suppression, the firefighters placed a second area gas sampling stand in the same location as the first sampling stand, to monitor the specific gas concentrations present during the overhaul activities. The smoke particle analyzer and extractive FTIR were restarted at the beginning of overhaul.

All recording devices were terminated 3 minutes after completion of the 30-minute overhaul sequence.

### **4.1.3 Bedroom**

The bedroom fire scenario represented a bedroom fire caused by a small open flame, such as a candle, inadvertently positioned close to a combustible object such as potpourri and an assortment of clothing on top of a dresser.

#### **Room Construction**

The bedroom structure possessed the same dimensions and was constructed using the same materials and practices as for the living room fire scenario. CAD drawings of the structure can be found in Appendix B.

#### **Furnishings**

The bedroom was furnished with items normally found in a bedroom setting: twin bed with bed clothing, night stand, dresser with a flat screen TV, potpourri on the dresser, clothing on the bed and dresser, newspaper, curtains, and ceiling fan with light bulbs. Figure 4-4 shows the bedroom scenario with the furnishings. Before and after fire test photos of additional furnishings can be found in Appendix C.

#### **Instrumentation**

The bedroom fire scenario was instrumented the same as the living room to characterize heat, smoke, and gas evolution during the course of the test.

#### **Test Sequence**

The bedroom fire scenario essentially followed the same test sequence as the living room scenario: test facility calorimeter exhaust duct flow of 60,000 cfm (1,700 m<sup>3</sup>/min); 3 minutes of baseline data collection for the OP-FTIR, extractive FTIR and smoke particle analyzer; ignition of the candle on the dresser; fire propagation to the basket of potpourri and newspapers on the dresser and then to the curtains, bedding, floor, and other furnishings; flashover; one additional minute of fire growth followed by 4 minutes of “teasing” suppression; full suppression; and finally 30 minutes of overhaul. The bench-top cascade impactor was initiated at the time of candle ignition and operated until suppression commenced.





**Figure 4-4: Photograph of the furnished bedroom interior. Note the gas and particle sampling probe extending into the right side of the room at standing face level.**

#### **4.1.4 Kitchen**

The kitchen fire scenario represented a candle inadvertently positioned close to a roll of paper towels placed on the kitchen counter. This fire scenario was based on a fire that reportedly occurred in Northern Illinois.

##### **Room Construction**

The kitchen structure possessed the same dimensions and was constructed using the same materials and practices as for the living room and bedroom fire scenarios. Whereas the living room and bedroom structures had carpeting, the kitchen floor was comprised of Pergo® engineered wood flooring floated over foam like the limited ventilation living room. CAD drawings of the structure can be found in Appendix B.

##### **Furnishings**

The kitchen was furnished with items normally found in a kitchen setting: floor and wall cabinets, Formica® counters, refrigerator, and a four person table and chairs on an area rug. Cabinets were stocked with food items, plastic dishes and cups, silverware, cleaning supplies, etc. Items on the counters included small appliances (blender, coffee maker, food processor, toaster), paper towels, cooking utensils, plastic drying rack, newspapers, and magazines. The table, in the front right corner of the kitchen, was set for four with plastic dishes and glasses. Kitchen lighting consisted of overhead canisters with compact fluorescent bulbs. Figure 4-5 shows the furnished kitchen scenario. Before and after fire test photos of additional furnishings can be found in Appendix C.



**Figure 4-5: Photograph showing the furnished kitchen interior.**

### **Instrumentation**

The kitchen was instrumented the same as the living room and bedroom with one additional piece of equipment, the bench-top cascade impactor. The sampling port for the bench-top cascade impactor was positioned to draw 100 Lpm from the upper left corner of the doorway.

### **Test Sequence**

The kitchen fire scenario essentially followed the same test sequence as the living room and bedroom fire scenarios: test facility calorimeter exhaust duct flow of 60,000 cfm (1,700 m<sup>3</sup>/min); 3 minutes of baseline data collection for the OP-FTIR, extractive FTIR and smoke particle analyzer; ignition of the candle; fire propagation to the paper towels, the coffee maker, the wood cabinets; flashover; one additional minute of fire growth followed by 4 minutes of “teasing” suppression; full suppression; and finally 30 minutes of overhaul. The bench-top cascade impactor was initiated at the time of candle ignition and operated until suppression commenced.

#### **4.1.5 Attic**

The attic fire scenario represented an attic fire caused by a small open flame, possibly resulting from electrical arcing.

### **Room Construction**

An attic over a single room was constructed using the same base room as for the living room, bedroom, and kitchen fire scenarios. The attic space was constructed using pre-engineered attic trusses fastened to the ceiling top plates with No. 16d nails or equivalent means. The attic roof consisted of 1/2 in. (1.3 cm) thick plywood covered with black tar paper and asphalt shingles. Ice and water shields were installed above soffits; a continuous ridge vent ran the length of the roof peak. The attic ceiling was insulated between rafters, from the soffit to the peak, with faced 12

in. (30 cm) R-38 insulation. Polystyrene vent sheets were installed between every other rafter. A 22×22 in. (56×56 cm) trap door was built into the roof to simulate a ventilation opening cut by firefighter during the course of roof venting operations.

A 36×24 in. (91×61 cm) sliding window was positioned in the center of the attic face side. An open 22×22 in. (56×56 cm) attic access panel was located in the front right and back left corners of the room. CAD drawings of the structure can be found in Appendix B.

### **Furnishings**

The attic was furnished with items that may be typically found in attic storage: cardboard boxes and plastic storage bins filled with books, toys and stuffed animals, newspaper, magazines, vinyl records, coffee maker, clothing and linens. Larger items furnished in the attic included an artificial Christmas tree and decorations and an infant mattress. Coaxial cable and PVC pipe was also placed in the attic to represent building construction components found in attic spaces. Figure 4-6 shows the furnished attic scenario. Before and after fire test photos of additional furnishings can be found in Appendix C.

The room underneath the attic was unfurnished.



**Figure 4-6: Photograph of the furnished attic space interior.**

### **Instrumentation**

The attic was instrumented similarly to the bedroom, living rooms, and kitchen to characterize heat, smoke, and gas evolution during the course of the test.

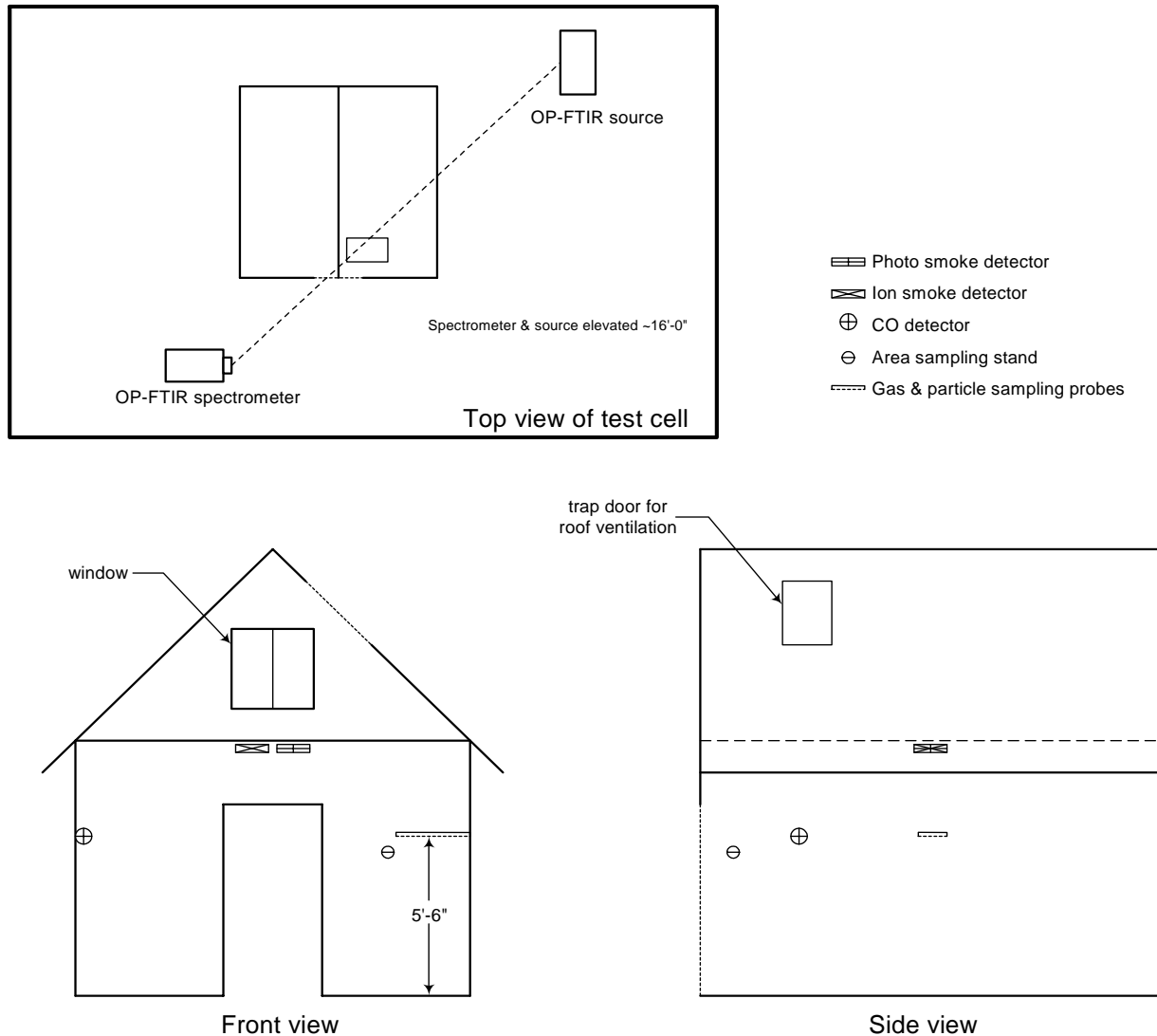
The OP-FTIR was operated in active mode. The spectrometer and IR source were positioned such that the beam path was 19 in. (48cm) above the roofline bisecting the open attic window

and the roof trap door. An optical path length corresponding to the emitted smoke plume of 2.5 m was used for gas concentration calculations.

Sampling probes for the extractive gas and smoke particle analyzers were positioned in the room below the attic at standing face height, nominal 5 ft 6 in. (1.68 m), at the lateral midpoint of the right room wall. The sampling probes were 9.5 mm in diameter with 5 holes spaced at 12.5 cm intervals and extended 79 cm into the room.

The sampling port for the bench-top cascade impactor was positioned to draw 100 Lpm from the bottom left corner of the attic window.

Area gas sampling stands were positioned in the front right corner of the room below the open attic access panel such that gas sampling was 4 ft (1.2 m) above the floor. Figure 4-7 shows a schematic diagram of the attic with the location of the instrument sampling points.



**Figure 4-7: Schematic diagram showing the instrumentation placement for the attic scenario**

### **Test Sequence**

The attic fire scenario essentially followed the same test sequence as the living room, bedroom, and kitchen fire scenarios: test facility calorimeter exhaust duct flow of 60,000 cfm (1,700 m<sup>3</sup>/min); 3 minutes of baseline data collection for the OP-FTIR, extractive FTIR and smoke particle analyzer; ignition of the candle; fire propagation to adjacent newspapers and books; and flashover. One minute after flash over the attic roof trap door was opened simulating firefighter roof ventilation operations. The fire was then “teased” for 4 minutes before full suppression and then followed with 30 minutes of overhaul. The OP-FTIR, extractive FTIR and smoke particle analyzer were operated throughout the test; the bench-top cascade impactor was initiated at the time of candle ignition and operated until suppression commenced.

#### **4.1.6 Wood Deck**

The wood deck fire scenario represented a deck fire started by an overturned charcoal grill.

##### **Deck and Room Construction**

The deck scenario was based on a 10×10 ft (3×3 m) deck attached to a house wall structure. Typical deck construction practices were followed: one beam attached along the “house” wall and another double beam parallel to the “house”, approximately 8 ft (2.4 m) from the house wall; nominal 2×8 in. (5×20 cm) pressure treated joists 16 in. (41 cm) OC attached perpendicular to the beams. The joists were attached to the beams with the joist hangers and fasteners. Nominal 5/4×4 in. (3×10 cm) treated wood deck boards were fastened perpendicular to the joists using deck screws.

The “house” consisted of a three wall structure, a 12 ft (3.7 m) wide wall facing the deck and adjacent side walls that extended 4 ft (1.3 m) deep. Floors, walls, ceiling and roof were constructed using the same materials and practices as for the other residence fires. Floors were covered with the same carpeting and carpet padding used in the bedroom and living room fire scenarios. The “house” exterior was clad with nominal 1/2 in. (1.3 cm) OSB sheathing covered with Tyvek® house wrap and a 6 in. (15 cm) profile 3/8 in. (1 cm) thick OSB Smart siding. The “house” included a 6×6 ft 8in. (1.8×2 m) sliding glass door opening to center of the deck

CAD drawings of the structure can be found in Appendix B.

##### **Furnishings**

The deck furnishings and materials consisted of a charcoal grill; resin chairs, table, and end tables; table umbrella; seat cushions; and 50 gallon deck storage boxes. Excelsior was placed under the deck simulating dry leaves under a deck; plastic sleds were stored under the deck. Figure 4-8 shows the wood deck scenario. Before and after fire test photos of additional furnishings can be found in Appendix C.

##### **Instrumentation**

The wood deck scenario was instrumented similarly to the other residential room scenarios to characterize heat, smoke, and gas evolution during the course of the test.

The OP-FTIR was operated in active mode. The spectrometer and IR source were positioned such that the beam path was along the deck facing wall, 13 ft 1 in. (4 m) above the deck surface and approximately 6 in. (15 cm) in front of the roof overhang. An optical path length corresponding to the emitted smoke plume of 3.0 m was used for gas concentration calculations.

Sampling probes for the extractive gas and smoke particle analyzers were positioned over the deck at standing face height, nominal 5 ft 6 in. (1.68 m), on the right of the sliding glass door. The sampling probes were 9.5 mm in diameter with 5 holes spaced at 12.5 cm intervals and extended 79 cm from the “house” wall.

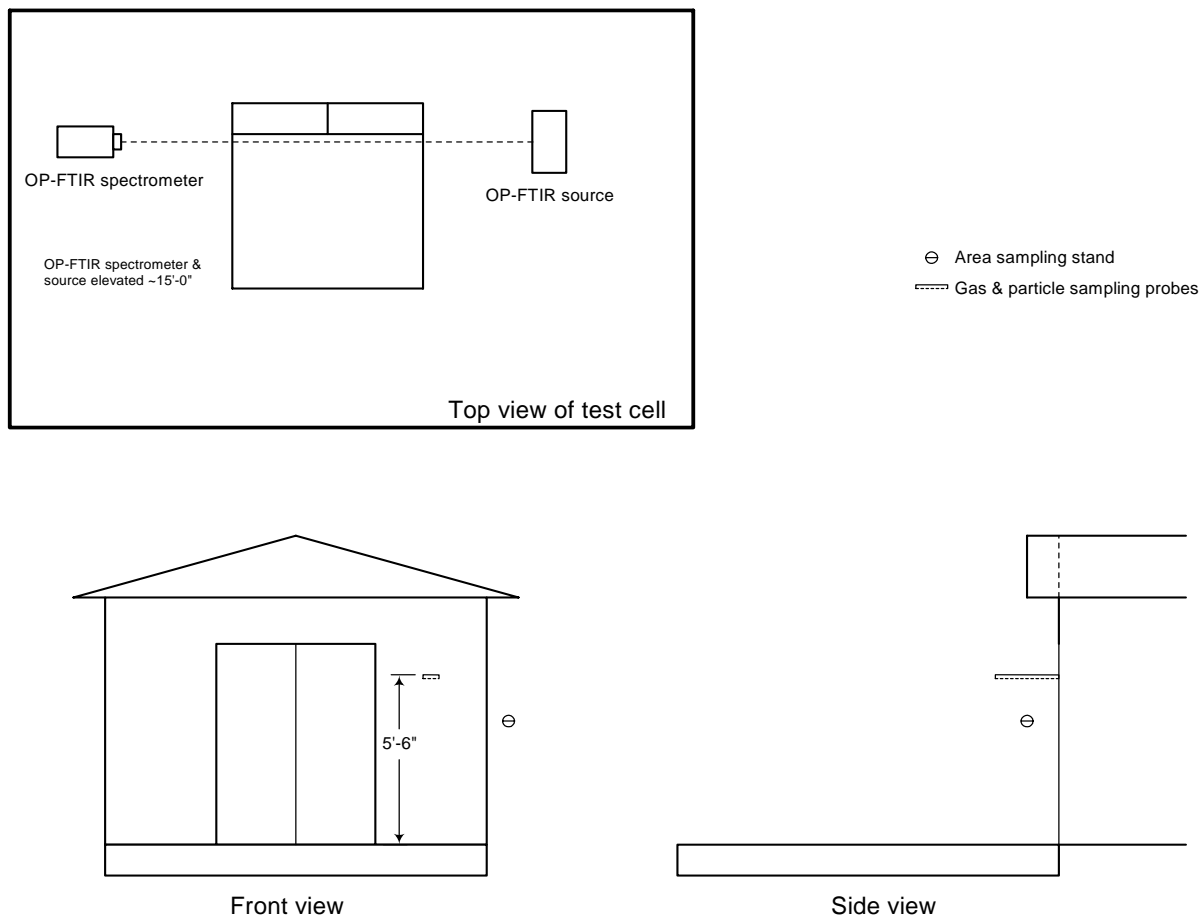
The sampling port for the bench-top cascade impactor was positioned to draw 100 Lpm from the above the center of the sliding glass door, 7 ft 9 in. (2.4 m) above the deck.

Area gas sampling stands were positioned to the right of the deck by the extractive FTIR and particle analyzer sampling probes such that gases were sampled 2.5 ft (0.6 m) above the deck.

Schematics of the deck and “house” structure with sampling locations is depicted in Figure 4-9.



**Figure 4-8: Photograph showing the wood deck scenario with furnishings. Note the the gas and particle sampling probe extending from the right of the sliding glass door over the deck at standing face level.**



**Figure 4-9: Schematic diagram showing the instrumentation placement for the deck scenario**

### Test Sequence

The wood deck fire was initiated by dumping the half of the hot coals from the grill onto the deck and the other half on to the excelsior protruding out from under the deck.

Prior to starting the test, a volumetric flow rate of 60,000 cfm (1,700 m<sup>3</sup>/min) was established through the test facility calorimeter exhaust duct. Baseline (i.e. background) measurements for the OP-FTIR, extractive FTIR, and smoke particle counter were collected for 3 minutes immediately prior to ignition. OP-FTIR measurements were continued throughout the test. Ambient temperature and relative humidity were also recorded.

The bench-top cascade impactor was initiated at the time of ignition and operated until suppression commenced.

Following ignition of the excelsior, the fire was allowed to propagate to the sleds and excelsior under the deck and to engage the deck furnishings. Similar to the other tests, the fire was allowed to grow until the deck and “house” side was fully engaged. The fire was then teased for 4 minutes prior to full suppression and subsequent 30 minutes of overhaul activities.

The two firefighters were outfitted with personal gas and particle sampling devices. Following suppression, the firefighters placed an area gas sampling stand by the deck to monitor the specific gas concentrations present during the overhaul activities. The extractive FTIR and smoke particle analysis were initiated at the beginning of the overhaul activities.

All recording devices were terminated 3 minutes after completion of the 30-minute overhaul sequence.

#### **4.1.7 Composite Deck**

The composite deck scenario represents a variation of the previously described wood deck fire scenario substituting polyolefin based wood plastic composite deck boards for the treated wood and vinyl siding for the OSB Smart siding.

##### **Deck and Room Construction**

The deck and “house” structure were identical to those used for the wood deck except for substituting polyolefin based wood plastic composite deck boards for the treated wood and double 4 in. (10 cm) vinyl siding for the OSB Smart siding. CAD drawings of the structure can be found in Appendix B.

##### **Furnishings**

The same deck furnishings and materials were used for the composite deck scenario as the wood deck scenario. Figure 4-10 shows the composite deck scenario. Before and after fire test photos of additional furnishings can be found in Appendix C.



**Figure 4-10: Photograph showing the composite deck scenario with furnishings.**



**Instrumentation**

The same instrumentation was used to characterize heat, smoke, and gas evolved during the course of the composite deck fire test as used for the wood deck fire scenario.

**Test Sequence**

The same test sequence was used for the composite deck fire scenario as used for the wood deck fire scenario.

**4.1.8 Automobile Passenger Compartment**

The automobile passenger compartment fire scenario represented a fire originating in the console panel of the passenger compartment, possibly due to a short circuit, and spreading to engulf the vehicle.

**Automobile Preparation**

A used 1998 Dodge Neon was utilized for the test. The vehicle was fully intact with all plastic components, seating materials, tires, carpeting, etc. A few slight modifications were made to the vehicle to reduce the potential risk of explosion: the battery was removed, the fuel tank was drained, and the tires were deflated. To compensate for the deflated tires the vehicle was set on concrete blocks. Before and after fire test photos of the vehicle can be found in Appendix C.

**Instrumentation**

The automobile passenger compartment fire scenario was instrumented similarly to the other residential room scenarios to characterize heat, smoke, and gas evolution during the course of the test.

The OP-FTIR was operated in active mode. The spectrometer and IR source were positioned such that the beam path was 9 ft 5 in. (2.9 m) above the vehicle roof along the open driver's window and the engine hood, Figure 4-12. An optical path length corresponding to the emitted smoke plume of 3.0 m was used for gas concentration calculations.

Sampling probes for the extractive gas and smoke particle analyzers were positioned 11 in. (28 cm) above the driver's window perpendicular to the side of the car for a standing face height of nominal 5 ft 6 in. (1.68 m). The 79 cm long sampling probes were 9.5 mm in diameter with 5 holes spaced at 12.5 cm intervals and extended 43 cm away from the side of the vehicle.

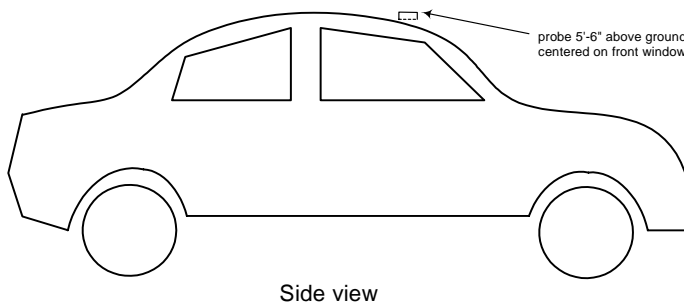
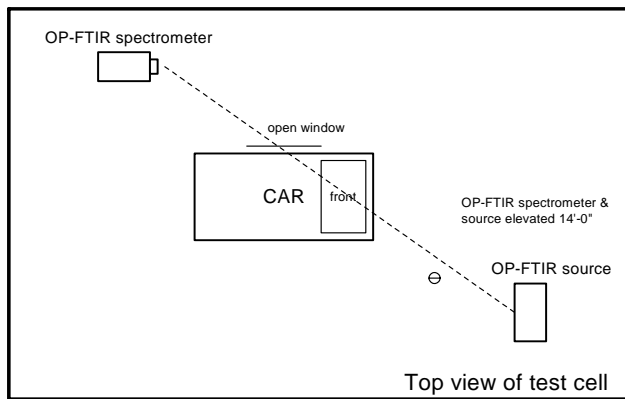
The sampling port for the bench-top cascade impactor was positioned to draw 100 Lpm from 3 ft 5 in. (1.0 m) away the driver's window and 7 ft 4 in. (2.2 m) above ground.

Area gas sampling stands were positioned approximately 10 ft (3.0 m) from the front right corner of the vehicle such that gases were sampled 4 ft (1.2 m) above ground.

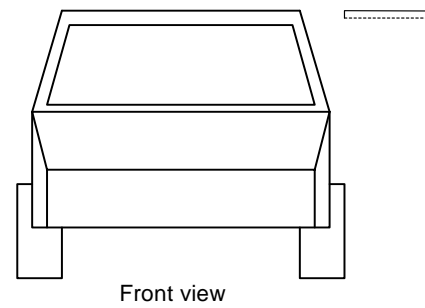
A photograph of the vehicle along with sampling equipment is shown in Figure 4-11. CAD drawings of the instrumentation relative to the vehicle can be found in Appendix B.



Figure 4-11: Photograph showing the automobile for the passenger compartment scenario



Side view



Front view

Figure 4-12: Schematic diagram showing the instrumentation placement for the automobile passenger compartment scenario

### **Test Sequence**

A small open flame in the radio bay of the front console, simulating the result of an electrical short, was used to initiate the vehicle fire. The initiating flame was created by remotely energizing a Nichrome wire wrapped around three bundled matches. The match bundle was taped to a polyethylene bag containing a 3 in. (7.5 cm) diameter by 2 in. (5 cm) long cellulosic bundle soaked with  $2 \pm 0.125$  fluid ounces ( $59 \pm 4$  mL) of gasoline.

Prior to starting the test, a volumetric flow rate of 60,000 cfm ( $1,700 \text{ m}^3/\text{min}$ ) was established through the test facility calorimeter exhaust duct. Baseline (i.e. background) measurements for the OP-FTIR, extractive FTIR, and smoke particle counter were collected for 3 minutes immediately prior to ignition. OP-FTIR measurements were continued throughout the test. Ambient temperature and relative humidity were also recorded.

The bench-top cascade impactor and an area gas sampling stand were initiated at the time of ignition. The cascade impactor was operated until suppression commenced. The area gas sampling stand was operated until the test was terminated.

Following ignition, the fire was allowed to propagate through the front console to passenger seats, engine compartment, tires, and trunk space. After the automobile was fully engaged, 30 minutes of suppression and overhaul activities were conducted.

The two firefighters were outfitted with personal gas sampling devices. Following suppression, the firefighters placed a second area gas sampling alongside of the other area gas sampling stand to monitor the specific gas concentrations present during the overhaul activities. The extractive FTIR and smoke particle analysis were initiated at the beginning of the overhaul activities.

All recording devices were terminated 3 minutes after completion of the suppression and overhaul sequence.

#### **4.1.9 Automobile Engine Compartment**

The automobile engine compartment fire represented a fire originating in the engine compartment, such as a vehicle fire arising from a fuel leak, and spreading to engulf the vehicle.

#### **Automobile Preparation**

A used 1998 Dodge Neon was prepared for this fire test in the same manner as for the passenger compartment fire scenario. Before and after fire test photos of the vehicle can be found in Appendix C.

#### **Instrumentation**

The automobile engine compartment fire scenario was instrumented similarly to the passenger compartment fire scenario to characterize heat, smoke, and gas evolution during the course of the test.

The OP-FTIR was operated in active mode. The spectrometer and IR source were positioned such that the beam path was 9 ft 5 in. (2.9 m) above the vehicle roof centered along the length of

the vehicle. An optical path length corresponding to the emitted smoke plume of 3.0 m was used for gas concentration calculations.

Sampling probes for the extractive gas and smoke particle analyzers were centered above the vehicle hood extending perpendicular to the side of the car at a standing face height of nominal 5 ft 6 in. (1.68 m). The 79 cm long sampling probes were 9.5 mm in diameter with 5 holes spaced at 12.5 cm intervals and extended 43 cm away from the side of the vehicle.

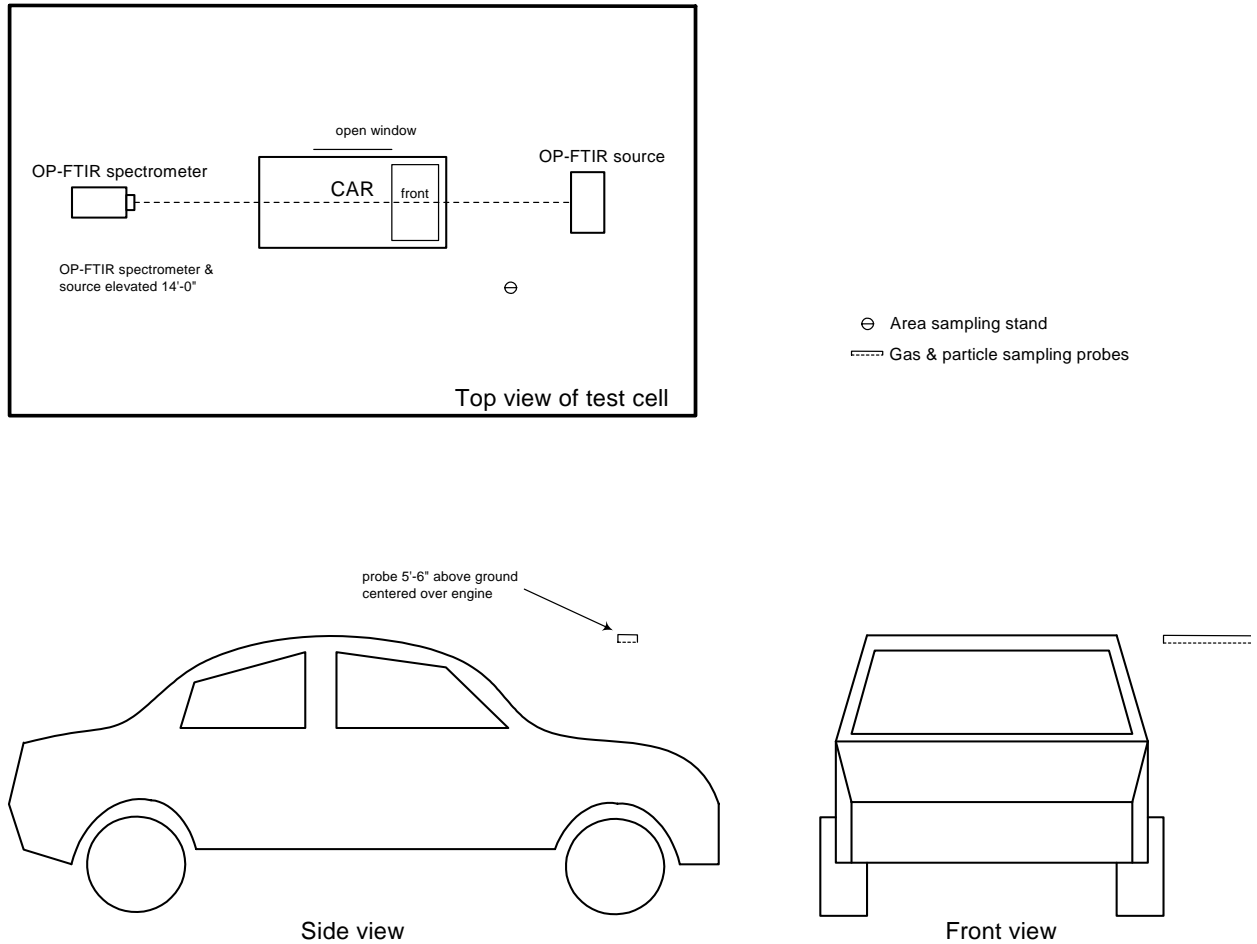
The sampling port for the bench-top cascade impactor was positioned to draw 100 Lpm from above the engine, 13 in. (33 cm) from the side of the car and 8 ft 1 in. (2.5 m) above ground.

Area gas sampling stands were positioned approximately 10 ft (3.0 m) from the front right corner of the vehicle such that gases were sampled 4 ft (1.2 m) above ground.

A photograph of the vehicle along with sampling equipment is shown in Figure 4-13. Schematics of the vehicle with equipment sampling locations are depicted in Figure 4-14. CAD drawings of the instrumentation relative to the vehicle can be found in Appendix B.



**Figure 4-13: Photograph showing the automobile for the engine compartment scenario**



**Figure 4-14: Schematic diagram showing the instrumentation placement for the automobile engine compartment scenario**

**Test Sequence**

The same test sequence was used for this fire test as for the passenger compartment fire scenario with the exception of the initiation.

A fuel line leak from a crack in the fuel delivery system was simulated in the engine compartment using a 1/4 in. (6 mm) copper tube with two drilled 0.041 in. (1 mm) holes attached to a recirculating gasoline feed line. The gasoline was ignited using the same type of initiation device as used for the passenger compartment fire. The initiation system is shown in Figure 4-15.



**Figure 4-15: Automobile engine compartment fire initiation device.**

## **4.2 EXPERIMENTAL**

Tests were conducted in Underwriters Laboratories' large-scale fire test laboratory. The burn facility is a nominal 50×50 ft (15.2×15.2 m) fire test cell equipped with a 25 ft (7.6 m) diameter collection hood. The center of the test cell floor is 30×30ft (9.1×9.1 m), is smooth and flat, and is surrounded with a grated drain to insure adequate floor water drainage from the test area. Four inlet ducts provide make up air in the test facility and are located at the walls 5 ft (1.5 m) above the test floor to minimize any induced drafts during the fire tests.

### **4.2.1 Heat and Smoke Release Rates**

Heat release rates during the fire growth phase were characterized based on the principles of oxygen consumption calorimetry; smoke release rates during the fire growth phase were similarly characterized based on obscuration principles. Measurements downstream from the collection hood were completed using a volumetric flow rate of 60,000 cfm (1,700 m<sup>3</sup>/min) through the room calorimeter duct. The heat release calorimeter was calibrated to a maximum total heat release rate of 10 MW prior to conducting each test.

### **4.2.2 Effluent Gas Composition – OP-FTIR**

Effluent gases escaping through the respective openings were analyzed using the OP-FTIR described in Section 2.2. The OP-FTIR was operated in the active mode for all of the fire tests as described for each fire in Section 4.1 Fire Events.

### **4.2.3 Effluent Gas Composition – Extractive FTIR**

Effluent gases were analyzed using the extractive FTIR described in Section 2.1. The FTIR was positioned and operated as described for each fire in Section 4.1 Fire Events.

#### **4.2.4 Smoke Particle Analyzer**

Smoke particle size and count distribution was characterized for the tests as described in Section 4.1 Fire Events using the WPS spectrometer described in Section 2.3.

#### **4.2.5 Smoke Particle Size Distribution**

Mass distributions of four different smoke particle size ranges generated during the fire tests were characterized using bench-top cascade impactor described in Section 2.6.

#### **4.2.6 Personal Air Sampling – Gas**

Firefighters were outfitted with 6-gas direct-reading personal gas monitors as described in Section 2.4. Monitors were calibrated prior to the test fire. Personal air monitoring at the fire scene was initiated prior to fire initiation and continued until suppression and overhaul were completed.

#### **4.2.7 Personal Air Sampling – Smoke Particle Size Distribution**

Airborne smoke particles in the firefighters personal area were collected using the four-stage personal cascade impactor described in Section 2.5. Sampling was initiated prior to fire initiation and continued until suppression and overhaul were completed. Each cut plate and the final filter from the used impactor was gravimetrically analyzed to determine the mass distribution of the collected particle sizes.

#### **4.2.8 Personal Air Sampling – Smoke Particle Inorganic Content**

Smoke particles collected on the different impactor cut plates were analyzed by inductively coupled plasma/mass spectroscopy (ICP/MS) for their inorganic element content (ICP-MS is described in Section 2.7). Phosphorus (P) concentration was measured using a modified NIOSH 7300 protocol, arsenic (As) concentration using a modified NIOSH 7303 protocol, and a modified OSHA ID-125G protocol was used to measure aluminum (Al), antimony (Sb), barium (Ba), beryllium (Be), cadmium (Cd), calcium (Ca), chromium (Cr), cobalt (Co), copper (Cu), iron (Fe), lead in air (Pb), lithium (Li), magnesium (Mg), manganese (Mn), molybdenum (Mb), nickel (Ni), potassium (K), selenium (Se), silver (Ag), sodium (Na), strontium (Sr), thallium (Tl), tin (Sn), titanium (Ti), vanadium (V), and zinc (Zn) concentrations.

#### **4.2.9 Effluent Gas Composition – Area Stands**

Concentrations of specific effluent gases and airborne chemicals were measured area sampling stands equipped with collection tubes. Benzene and styrene vapor were collected using catecholamine treated charcoal tubes; formaldehyde using 2,4-DNPH treated silica gel tube; hydrogen cyanide using a soda lime tube; PAHs using a washed XAD-2 tube; and airborne mercury using a Hydrar tube. Area stands were also outfitted with a sealed set of tubes to serve as reference. The amount of analyte collected in the tubes was determined by the GC-MS, HG-AAS, and HPLC techniques described in Sections 2.8 through 10. Concentrations measured for the front side of the tubes was compared to the back side to confirm that the collection tubes did not saturate during the exposure.

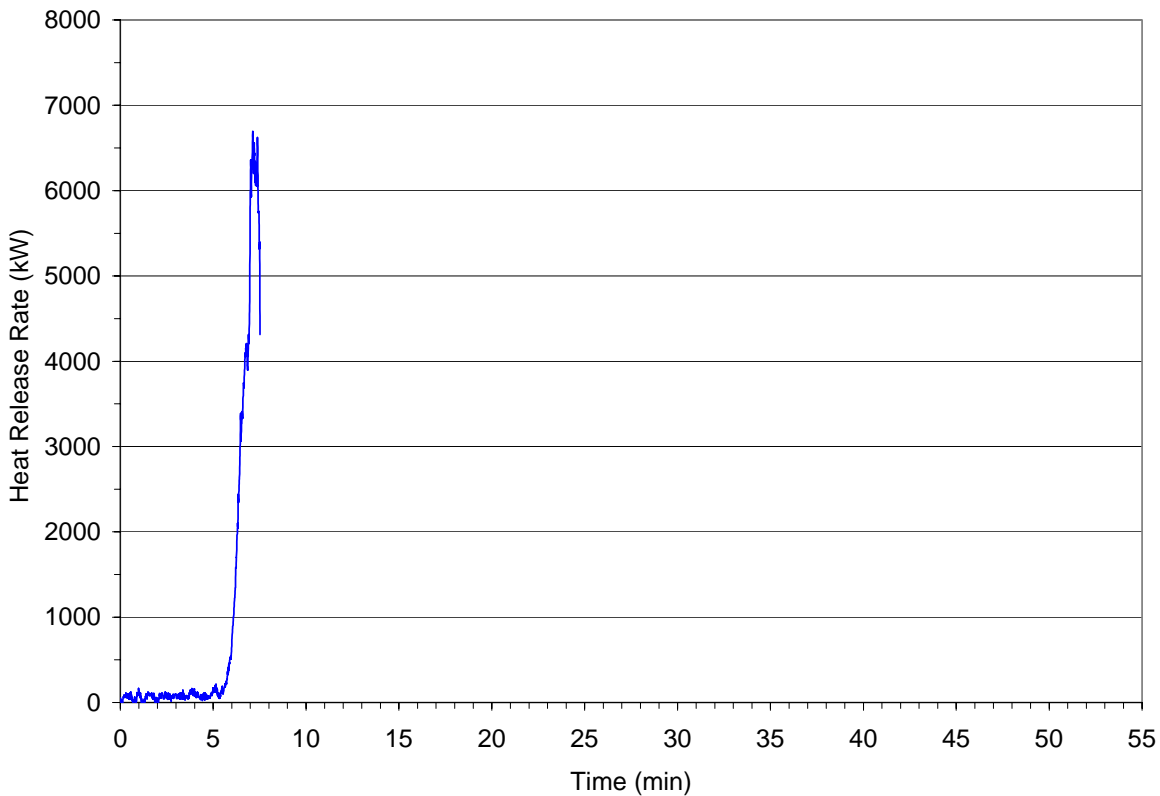
## 4.3 RESULTS

### 4.3.1 Living Room

Following ignition of the candle, the candle flame ignited the sofa and propagated to the adjacent loveseat and other room furnishings. Flashover of the room occurred 6:30 minutes after candle ignition. The ionization smoke alarm activated 4:16 minutes after candle ignition and the photoelectric smoke alarm followed 2 seconds later. The carbon monoxide alarm activated 6 seconds after flashover.

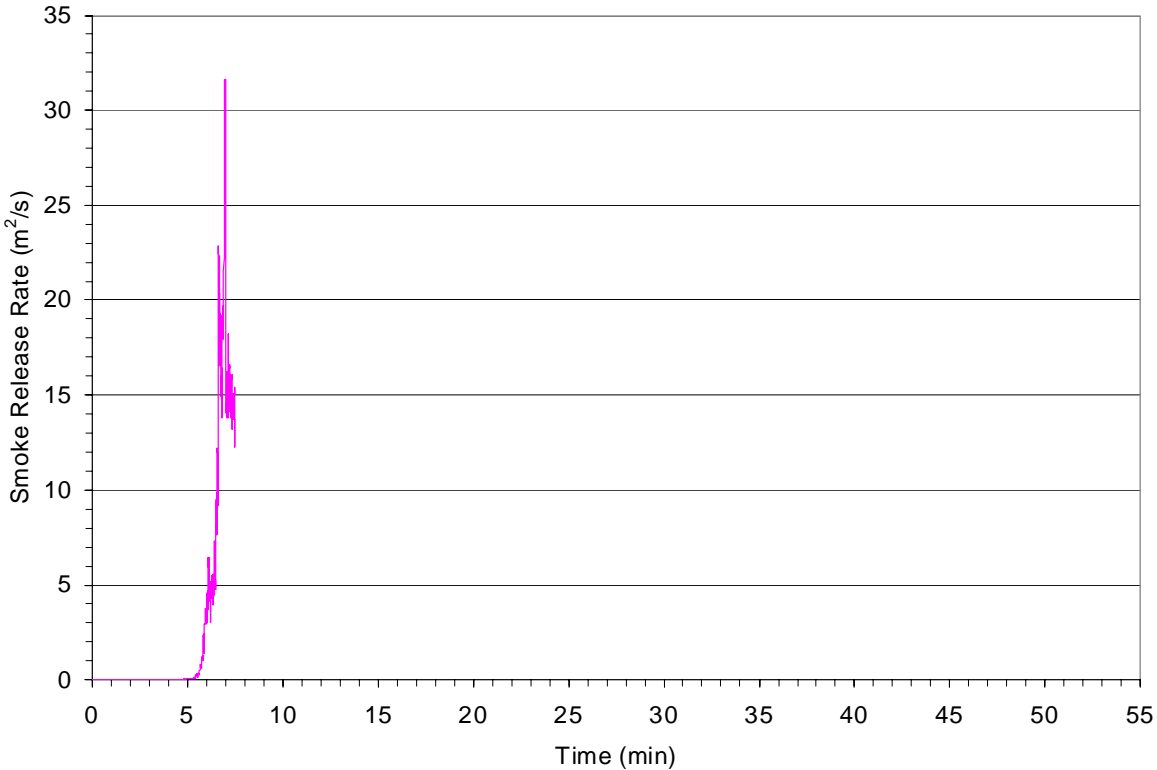
#### Heat and Smoke Release Rates

Graphs of the heat and smoke release rates for the living room fire scenario are shown in Figure 4-16 and Figure 4-17 respectively. For the first 5½ minutes of the fire the heat release rate was relatively low, around 200 kW. Within one minute the fire grew to flashover with a HRR of approximately 3 MW and continued to grow at that rate to almost 7 MW before suppression was started. Correspondingly virtually no smoke was detected with the calorimeter hood for the first 5½ minutes after which it rapidly grew to approximately 8.5 m<sup>2</sup>/s by flashover and continued to increase to more than 31 m<sup>2</sup>/s before suppression was started.



**Figure 4-16: Heat release rate during the fire growth phase of the living room fire.**

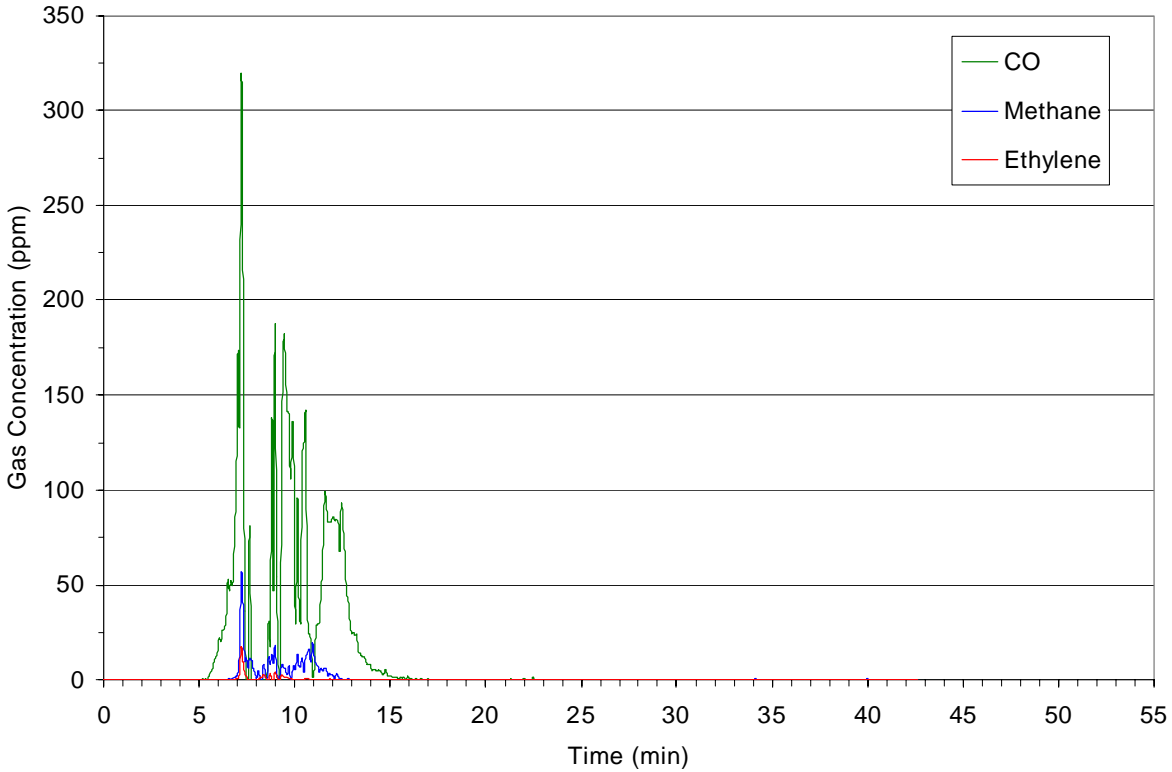




**Figure 4-17: Smoke release rate during the fire growth phase of the living room fire.**

### **Effluent Gas Composition – OP-FTIR**

Concentrations of gases escaping the living room doorway were measured by OP-FTIR for the duration of the fire test. Results for gases other than water and carbon dioxide are plotted in Figure 4-18. Note the rapid rise in gas concentrations corresponding to the same time frames as the rise in heat and smoke release rates. At the time of flashover, carbon monoxide concentration was approximately 50 ppm and methane and ethylene were less than 0.1 ppm. During the suppression teasing phase gas concentrations were erratic depending on whether water was being applied or the fire was being allowed to grow. At the end of suppression the carbon monoxide concentration was approximately 85 ppm, methane was 2 ppm, and ethylene less than 0.1 ppm. Within 5 minutes of commencing overhaul, 12:25 minutes after ignition, gas concentrations decreased by an order of magnitude.



**Figure 4-18: Gas concentration measured by OP-FTIR for the living room fire.**

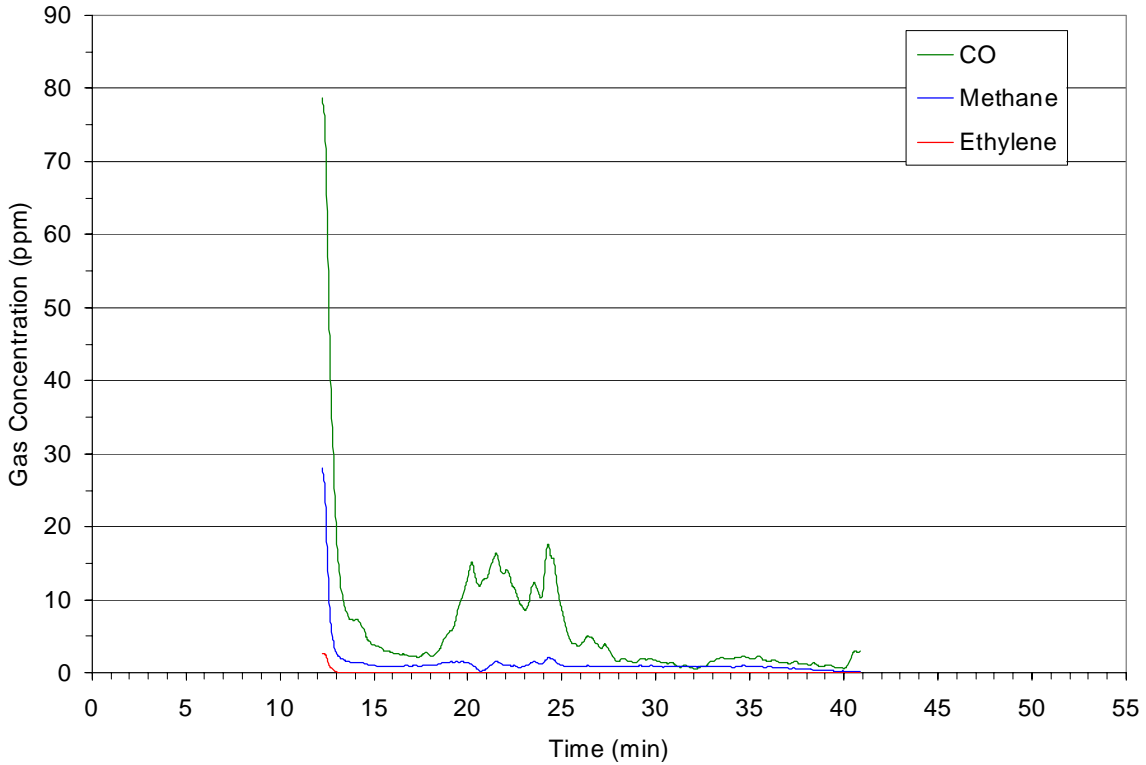
Peak gas concentrations and calculated total exposures are summarized in Table 4-1.

**Table 4-1: Summary of OP-FTIR gas concentration data for the living room fire.**

| Gas      | Peak concentration (ppm) | Total exposure (ppm-min) |
|----------|--------------------------|--------------------------|
| CO       | 318.5                    | 481.9                    |
| Methane  | 56.4                     | 45.2                     |
| Ethylene | 17.4                     | 6.7                      |

**Effluent Gas Composition – Extractive FTIR**

Concentrations of gases in the living room area were measured during overhaul by extractive FTIR. Results for gases other than water and carbon dioxide are plotted in Figure 4-19. Gas concentrations at the start of overhaul were approximately 79 ppm for carbon monoxide, 28 ppm for methane, and 2.6 ppm for ethylene. Within 2 minutes however concentrations decreased by an order of magnitude. There was roughly an 8X rise in carbon monoxide concentration while the firefighters were pulling down drywall and insulation, 18 to 26 minutes after ignition.



**Figure 4-19: Gas concentration measured by extractive FTIR during overhaul of the living room fire.**

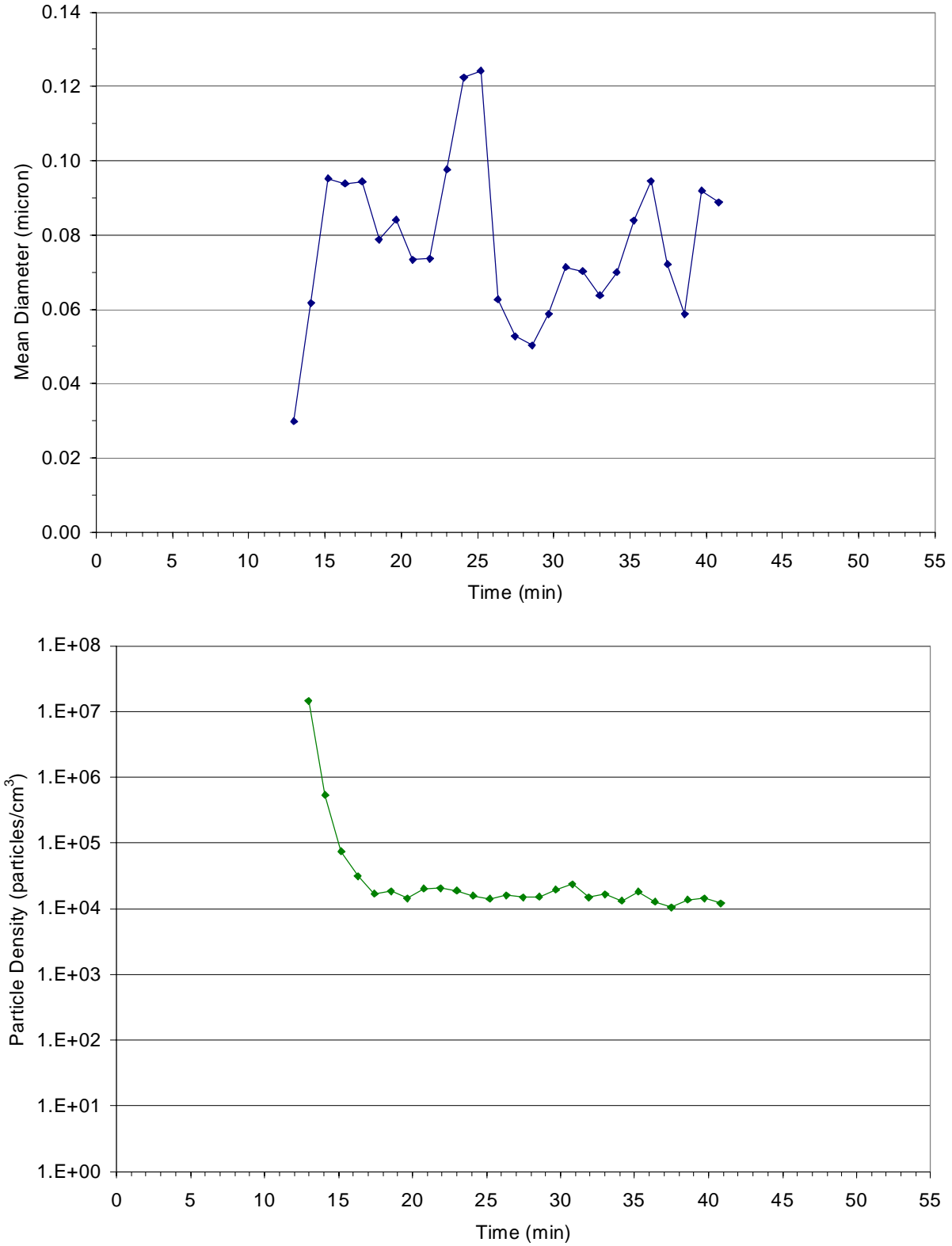
Peak gas concentrations and calculated total exposures are summarized in Table 4-2.

**Table 4-2: Summary of extractive FTIR gas concentration data for overhaul of the living room fire.**

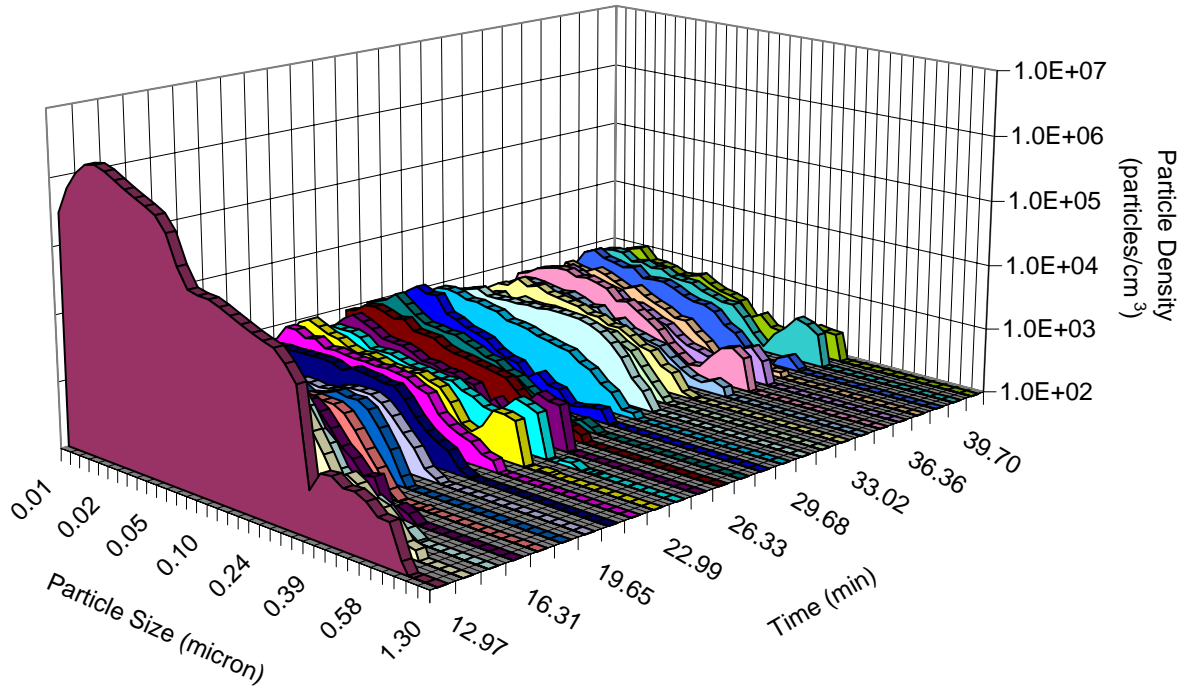
| Gas      | Peak concentration (ppm) | Total exposure (ppm-min) |
|----------|--------------------------|--------------------------|
| CO       | 78.7                     | 168.1                    |
| Methane  | 28.1                     | 36.0                     |
| Ethylene | 2.7                      | 1.0                      |

### Smoke Particle Analyzer

The average smoke particle size and particle count density as characterized with the WPS spectrometer for overhaul is depicted in Figure 4-20. Despite the variety of activity occurring during overhaul, the average smoke particle size remains fairly consistent at  $0.078 \pm 0.021$  microns. The particle count density however undergoes a three order reduction during the first 5 minutes of overhaul to stabilize at  $16,100 \pm 3,100$  particles per cubic centimeter. As seen in the plot of the particle size distribution, Figure 4-21, particles measuring less than 0.32 microns were the most prevalent.



**Figure 4-20: Smoke particle average size (top) and count density (bottom) measured with the particle analyzer during overhaul of the living room fire.**



**Figure 4-21: Smoke particle size distribution measured with the particle analyzer during overhaul of the living room fire.**

**Personal Air Sampling – Gas**

Two firefighters wore personal gas monitors and impactors during overhaul operations. Measured gas concentrations are plotted in Figure 4-22. Spikes in the personal gas concentration correspond to when the firefighters were pulling down drywall and insulation (increases in room gas concentrations were also observed for this time period by extractive FTIR).

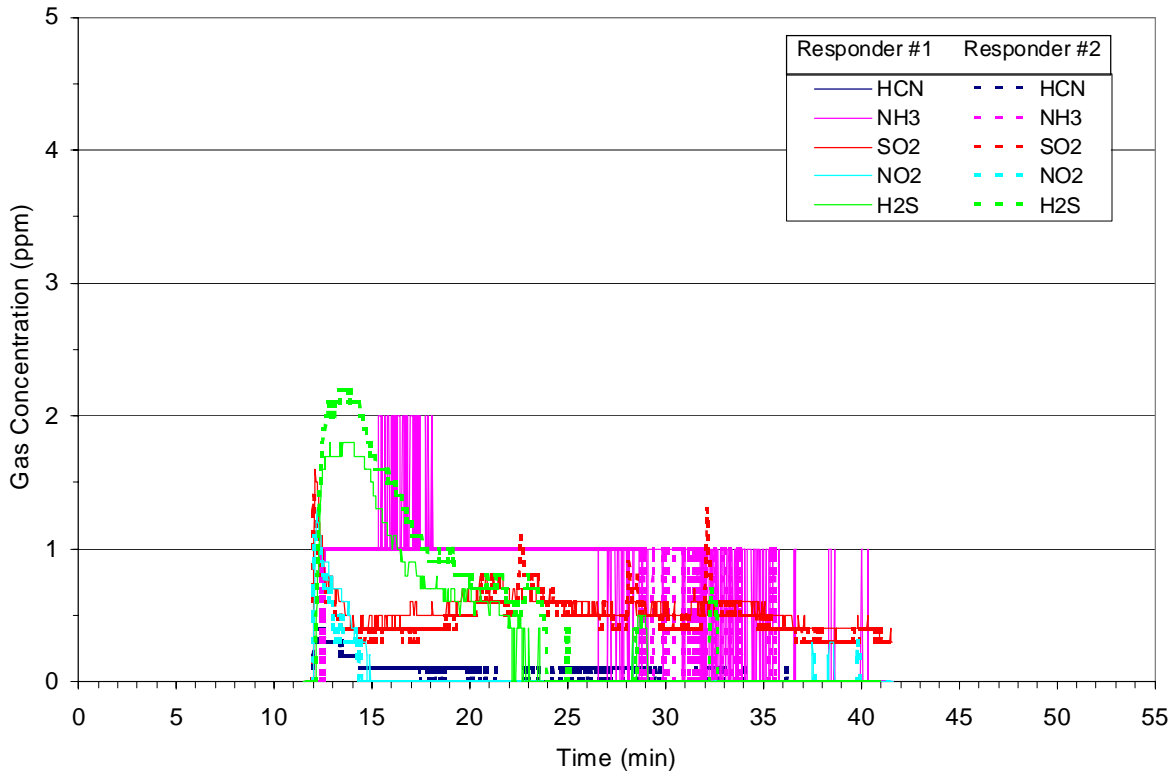
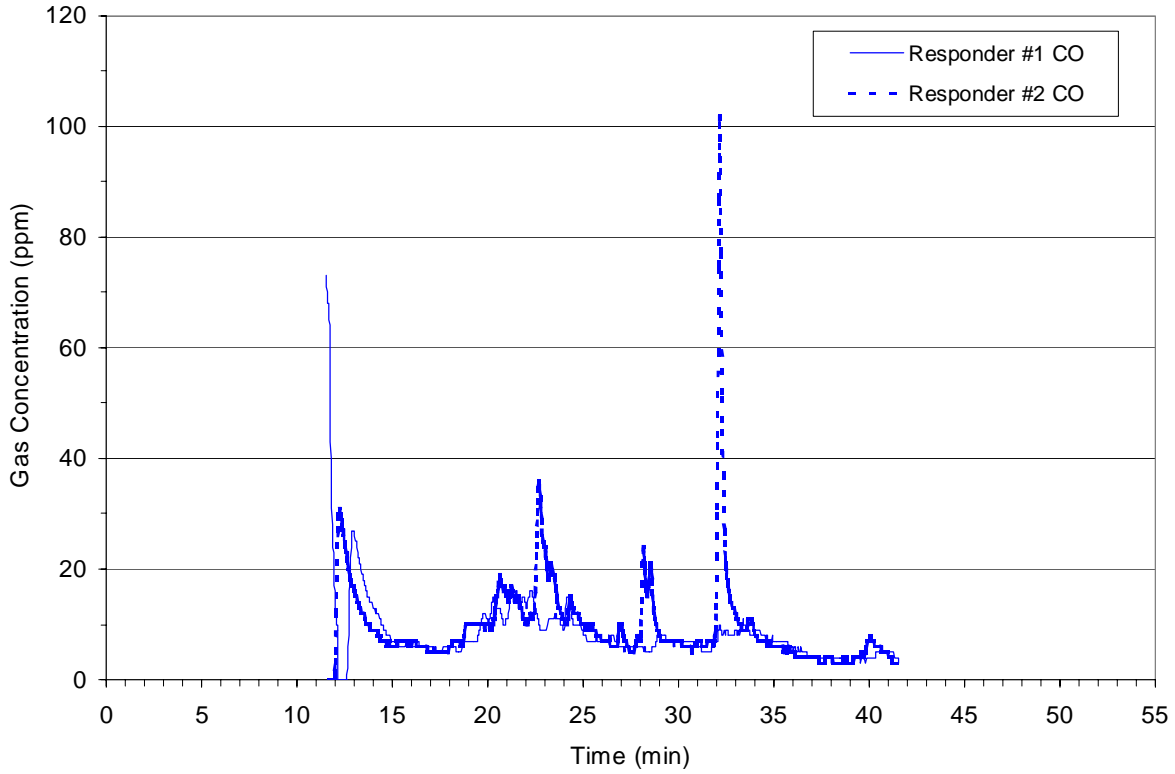


Figure 4-22: Gas concentrations measured by personal monitors during overhaul of the living room fire.

Peak gas concentrations and calculated total exposures for the two firefighters are summarized in Table 4-3.

**Table 4-3: Summary of personal gas monitor data for overhaul of the living room fire.**

| Gas              | Responder #1             |                          | Responder #2             |                          |
|------------------|--------------------------|--------------------------|--------------------------|--------------------------|
|                  | Peak concentration (ppm) | Total exposure (ppm-min) | Peak concentration (ppm) | Total exposure (ppm-min) |
| HCN              | 0.0                      | 0.0                      | 0.4                      | 1.6                      |
| NH <sub>3</sub>  | 2.0                      | 22.7                     | 1.0                      | 18.0                     |
| SO <sub>2</sub>  | 1.6                      | 16.3                     | 1.4                      | 14.4                     |
| NO <sub>2</sub>  | 1.3                      | 1.9                      | 1.1                      | 1.4                      |
| H <sub>2</sub> S | 1.8                      | 10.7                     | 2.2                      | 14.3                     |
| CO               | 73.0                     | 253.1                    | 102                      | 290.1                    |

**Personal Air Sampling – Smoke Particle Size Distribution**

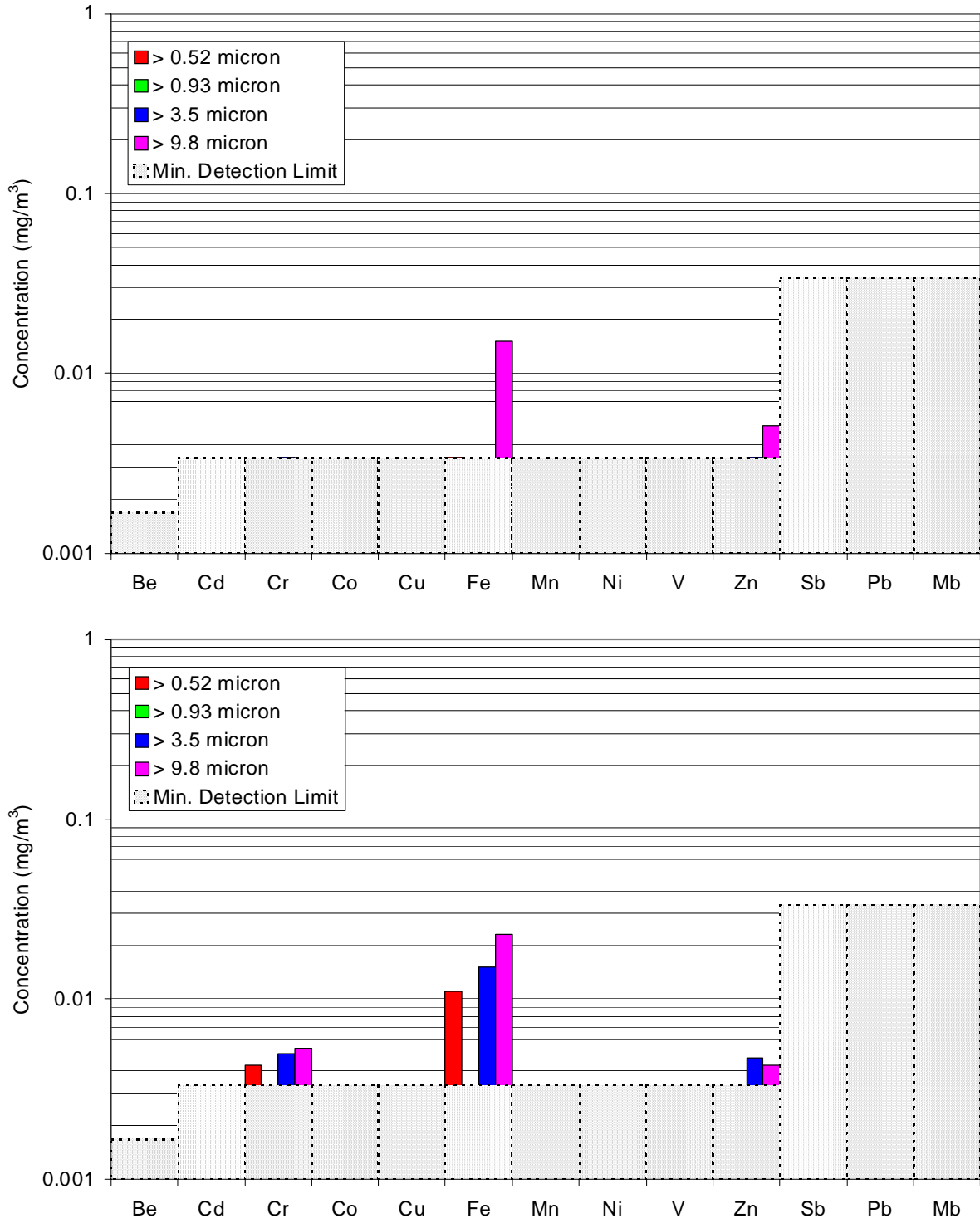
Analysis of the smoke particles accumulated on the four personal cascade impactor cut plates (0.52, 0.93, 3.5, 9.8 micron) worn by the two firefighters, Table 4-4, reveals that the relative mass distributions are slightly different for the two firefighters but in both cases the largest particle sizes, greater than 9.8 microns, were prevalent.

**Table 4-4: Mass distribution of smoke particles collected on personal cascade impactors during overhaul of the living room fire.**

| Particle Size | % Mass Fraction |                |
|---------------|-----------------|----------------|
|               | Firefighter #1  | Firefighter #2 |
| > 0.52 micron | 2.1             | 1.4            |
| > 0.93 micron | 3.1             | 13.1           |
| > 3.5 micron  | 16.0            | 28.5           |
| > 9.8 micron  | 78.7            | 56.9           |

**Personal Air Sampling – Smoke Particle Inorganic Content**

Inorganic elemental analysis of the smoke particulates collected with the personal impactor worn by the firefighters are plotted in Figure 4-23. Only chromium, iron and zinc concentrations were measurable in the collected particles.



**Figure 4-23: Inorganic element concentrations measured for smoke particles collected with personal cascade impactors during overhaul of the living room fire.**



**Effluent Gas Composition – Area Stands**

Average airborne benzene, styrene and formaldehyde concentrations in the living room were determined for the 30 minute overhaul operation period using the collection tubes on an area sampling stand. Results are summarized in Table 4-5.

**Table 4-5: Gas concentrations collected with area sampling stand during overhaul of the living room fire.**

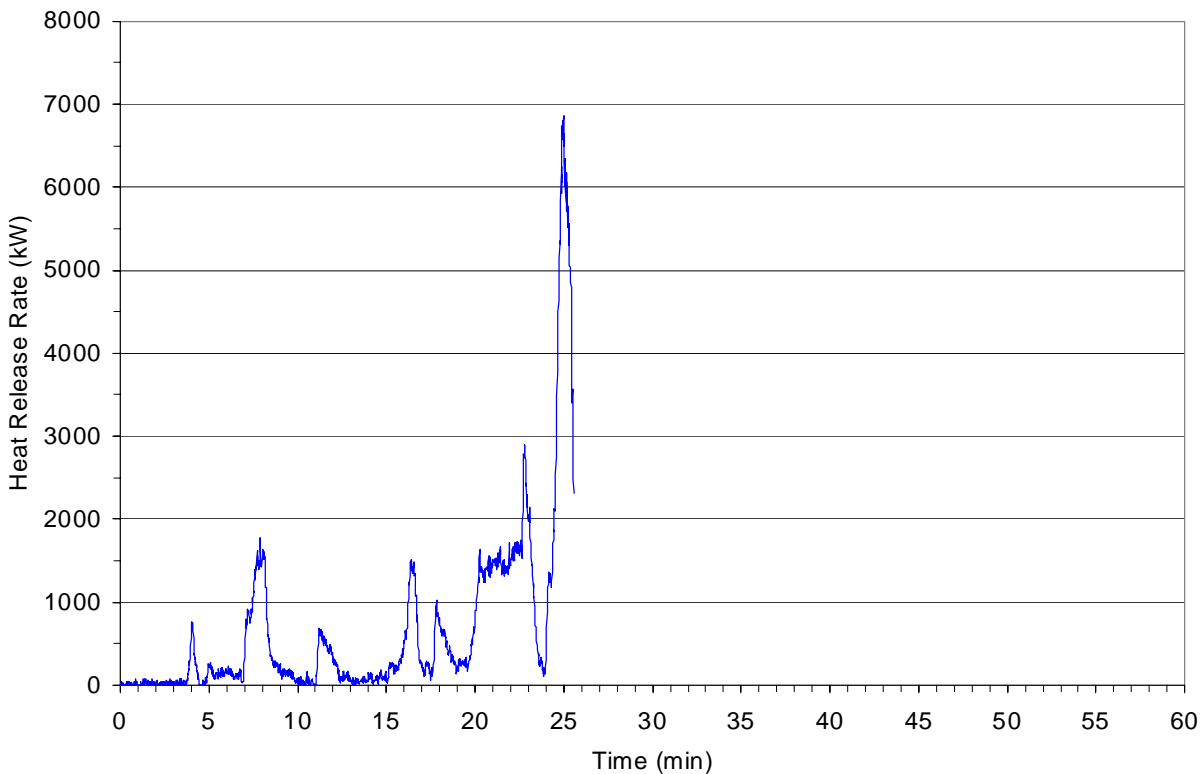
| <b>Species</b> | <b>Detection Limit<br/>(<math>\mu\text{g}</math>)</b> | <b>Mass<br/>(<math>\mu\text{g}</math>)</b> | <b>Concentration</b> |
|----------------|---|--|----------------------|
| Benzene        | 1.0   | <1.1                                       | <0.055 ppm           |
| Styrene        | 1.2   | 7.1  | 0.27 ppm             |
| Formaldehyde   | 0.1   | 3.5  | 0.38 ppm             |

### 4.3.2 Living Room - Limited Ventilation

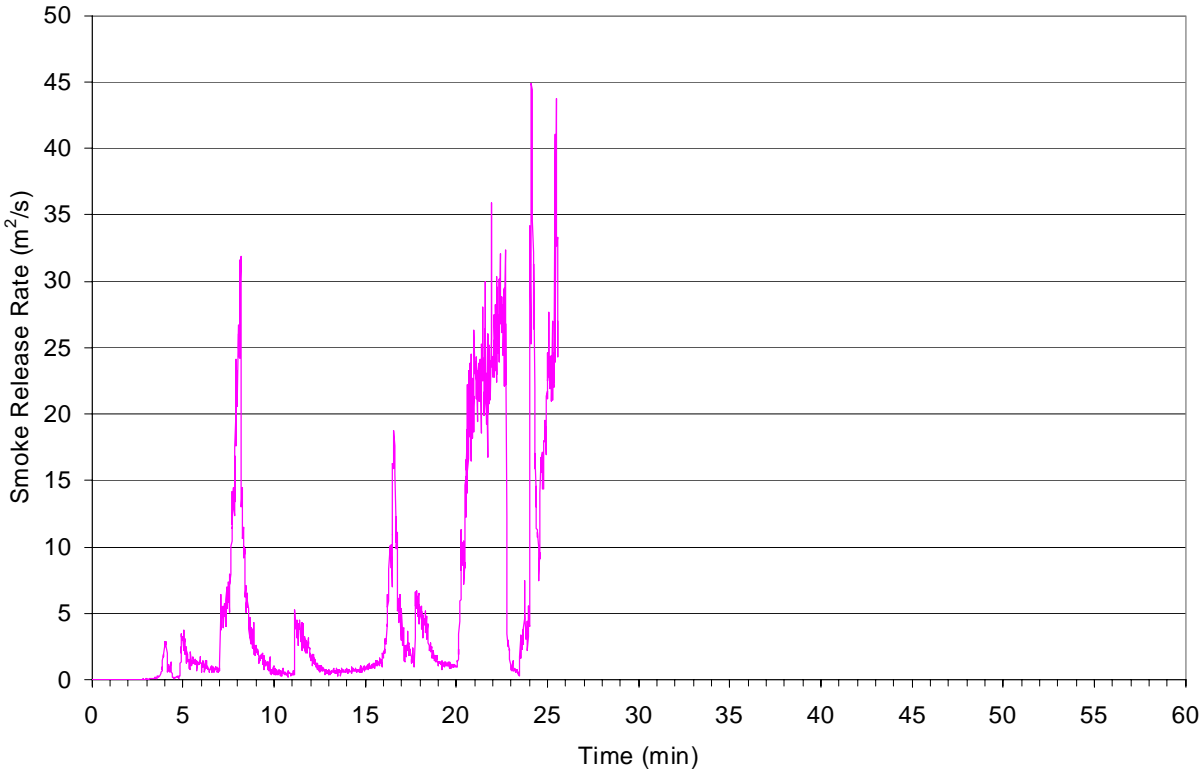
Following ignition of the candle, the candle flame ignited the sofa and propagated to the adjacent loveseat and other room furnishings. The ionization smoke alarm activated 1:14 minutes after candle ignition and the photoelectric smoke alarm followed 23 seconds later. The carbon monoxide alarm activated 4:08 minutes after ignition, which was almost 3 minutes after the ionization alarm.

#### Heat and Smoke Release Rates

Graphs of the heat and smoke release rates for the living room fire scenario are shown in Figure 4-24 and Figure 4-25 respectively. For the first 3:45 minutes of the fire the heat release rate was less than 100 kW. In the next 20 seconds the fire grew to more than 700 kW at which time the door was closed restricting air available to the fire. In the next 20 seconds the HRR receded to less than 100 kW. Subsequent door opening and closing cycles resulted in sharp HRR increases and decreases until the upper door panels burned through. Once the doorway panels were burned through, the door was left open and the fire eventually reached a HRR of 6.9 MW prior to commencing suppression. Flames passed out of the doorway at HRR of approximately 1.6 MW. Smoke release rates corresponded with the HRR and eventually reached 45 m<sup>2</sup>/s.



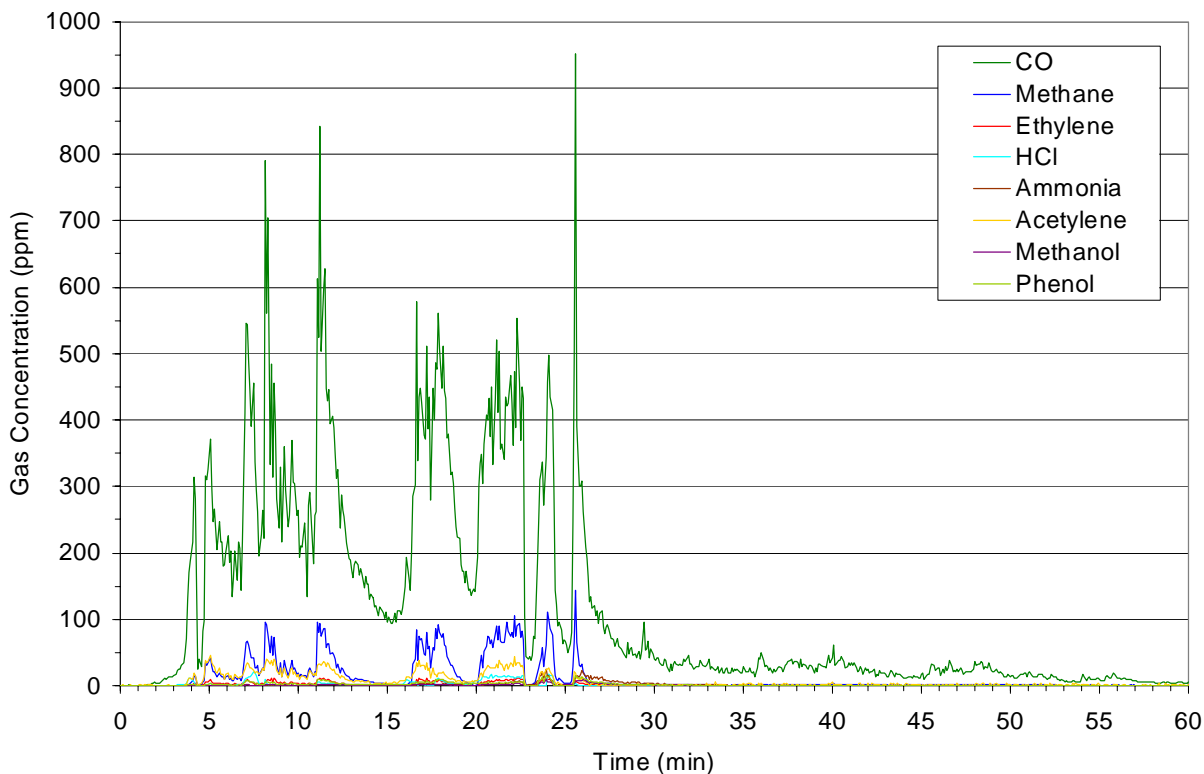
**Figure 4-24: Heat release rate during the fire growth phase of the limited ventilation living room fire.**



**Figure 4-25: Smoke release rate during the fire growth phase of the limited ventilation living room fire.**

### **Effluent Gas Composition – OP-FTIR**

Concentrations of gases escaping the living room doorway were measured by OP-FTIR for the duration of the fire test. Results for gases other than water and carbon dioxide are plotted in Figure 4-26. Note the increases and decreases in gas concentrations corresponding to the changes in fire size resulting from the changing air availability. Carbon monoxide concentrations exceeded 400 ppm on a repeated basis and reached as high as 950 ppm when suppression was started. Methane was the only other gas exceeding 50 ppm, reaching 145 ppm prior to suppression. Within 2 minutes of commencing suppression, carbon monoxide and methane gas concentrations decreased by 1 to 2 orders of magnitude and concentrations of other gases decreased by a factor of five. Only carbon monoxide (other than water and carbon dioxide) exhibited concentrations exceeding 10 ppm after two minutes of suppression.



**Figure 4-26: Gas concentration measured by OP-FTIR for the limited ventilation living room fire.**

Peak gas concentrations and calculated total exposures are summarized in Table 4-6.

**Table 4-6: Summary of OP-FTIR gas concentration data for the limited ventilation living room fire.**

| Gas       | Peak concentration (ppm) | Total exposure (ppm-min) |
|-----------|--------------------------|--------------------------|
| CO        | 952.0                    | 7210.4                   |
| Methane   | 144.5                    | 767.0                    |
| Ethylene  | 12.5                     | 101.3                    |
| HCl       | 20.2                     | 90.7                     |
| Ammonia   | 24.8                     | 85.2                     |
| Acetylene | 46.0                     | 410.2                    |
| Methanol  | 9.7                      | 48.2                     |
| Phenol    | 14.5                     | 98.9                     |

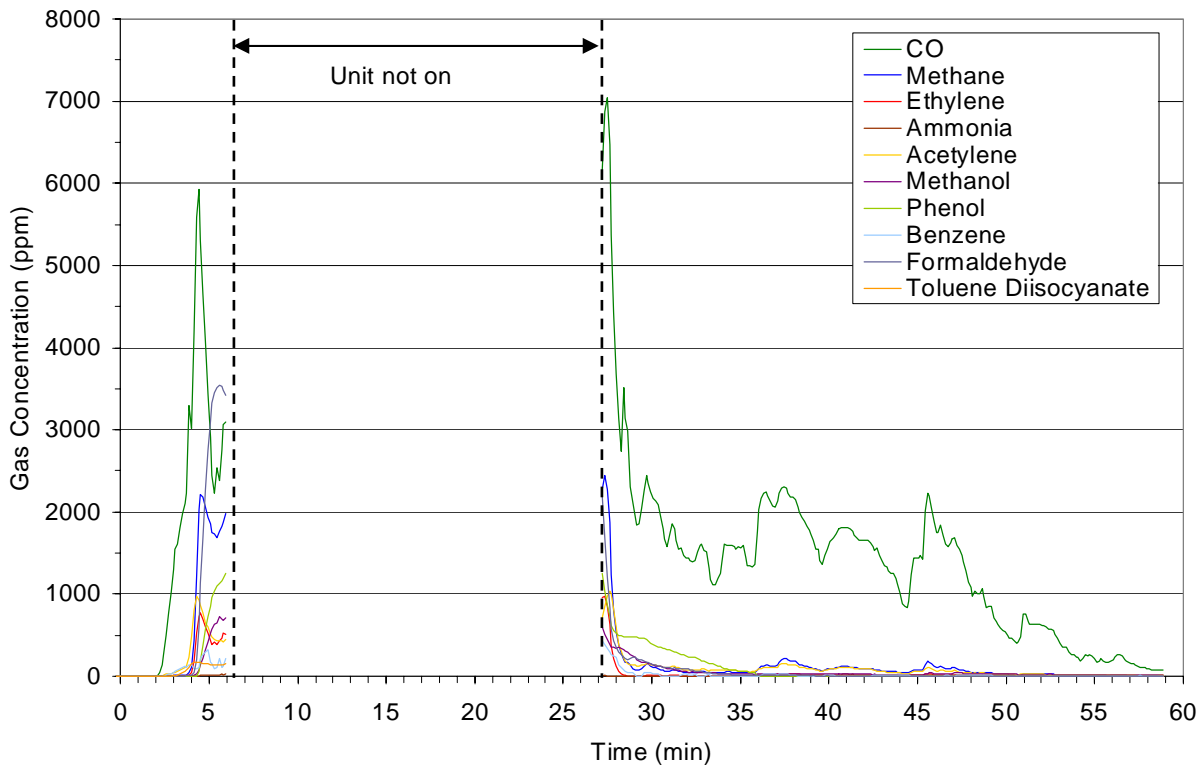
**Effluent Gas Composition – Extractive FTIR**

Concentrations of gases in the room were measured by extractive FTIR. The extractive FTIR was only able to collect data for the first 6 minutes of the fire growth phase before the protective particle filter was clogged. The extractive FTIR with a fresh filter was restarted at overhaul. Concentrations of gases other than water and carbon dioxide measured during these two periods are plotted in Figure 4-27.

During the initial 6 minutes of fire growth multiple gases were found and at great concentrations: carbon monoxide exceeded 5,000 ppm; formaldehyde exceeded 3,500 ppm, methane exceeded 2,200 ppm; phenol was at 1,250 ppm and still increasing; acetylene exceeded 925 ppm; ethylene

exceeded 775 ppm; methanol was at 750 ppm and still increasing, benzene exceeded 325 ppm; toluene diisocyanate, a precursor for polyurethane foam, was found in concentrations greater than 100 ppm for more than two minutes; and ammonia was approximately 25 ppm and still increasing.

After the extractive FTIR was restarted to monitor gas concentrations in the room during overhaul, gas concentrations were comparable to the 6<sup>th</sup> minute of fire growth (immediately prior to filter clogging). Within one minute, however, gas concentrations decreased by 2 to 10X. Within 10 minutes of commencing overhaul, concentrations of all the gases but carbon monoxide, methane, and acetylene (and carbon dioxide and water) were less than 50 ppm. Carbon monoxide however remained above 1,000 ppm for more than 20 minutes after commencing overhaul.



**Figure 4-27: Gas concentration measured by extractive FTIR for the limited ventilation living room fire. Peak gas concentrations and calculated total exposures are summarized in Table 4-7.**

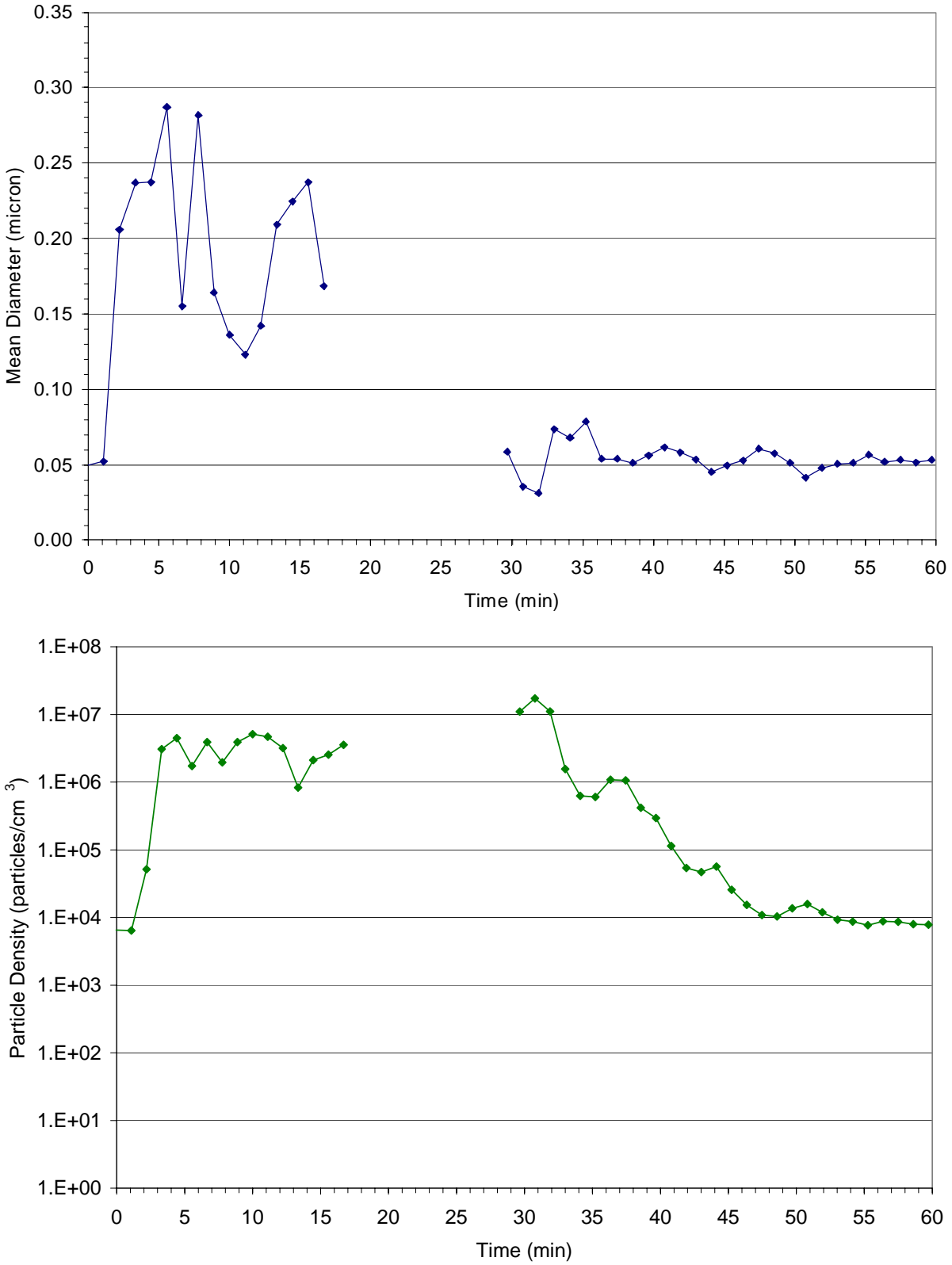
**Table 4-7: Summary of extractive FTIR gas concentration data for the limited ventilation living room fire.**

| Gas                  | Fire Growth              |                          | Overhaul                 |                          |
|----------------------|--------------------------|--------------------------|--------------------------|--------------------------|
|                      | Peak concentration (ppm) | Total exposure (ppm-min) | Peak concentration (ppm) | Total exposure (ppm-min) |
| CO                   | 5926.4                   | 9685.5                   | 7036.6                   | 43747.7                  |
| Methane              | 2217.2                   | 33656.3                  | 2438.2                   | 3559.0                   |
| Ethylene             | 777.5                    | 975.5                    | 969.8                    | 814.8                    |
| Ammonia              | 24.7                     | 30.2                     | 25.2                     | 426.7                    |
| Acetylene            | 968.8                    | 1352.9                   | 1040.5                   | 2890.1                   |
| Methanol             | 726.5                    | 793.6                    | 602.0                    | 1783.6                   |
| Phenol               | 1250.4                   | 1294.0                   | 1262.7                   | 2706.4                   |
| Benzene              | 325.1                    | 459.6                    | 440.9                    | 644.6                    |
| Formaldehyde         | 3548.6                   | 4463.4                   | 2201.9                   | 1747.3                   |
| Toluene diisocyanate | 180.4                    | 369.8                    | --                       | --                       |

### Smoke Particle Analyzer

The average smoke particle size and particle count density as characterized with the WPS spectrometer during the fire growth phase and for overhaul is depicted in Figure 4-28. The average smoke particle size during the fire growth phase (i.e. the first 17 minutes of data collection) varied between 0.12 and 0.29 microns. There is not a clear relationship between particle size and ventilation condition, i.e. door opened or closed. During the incipient fire growth phase, the first 6 minutes following ignition, the particle size distributions, Figure 4-29, resemble those measured for synthetic materials. Later the distribution profile takes on a different shape suggesting a change in the chemistry of the burning materials. Smoke particle concentration during the incipient phase of the fire, however increases by three orders of magnitude in less than 2.5 minutes and then remains fairly constant for the remainder of the fire growth phase.

Despite the variety of activity occurring during overhaul, the average smoke particle size remains fairly consistent at  $0.054 \pm 0.010$  microns. The particle count density however undergoes a steady three order reduction during the first 19 minutes of overhaul to stabilize at  $10,500 \pm 2,800$  particles per cubic centimeter.



**Figure 4-28: Smoke particle average size (top) and count density (bottom) measured with the particle analyzer for the limited ventilation living room fire.**

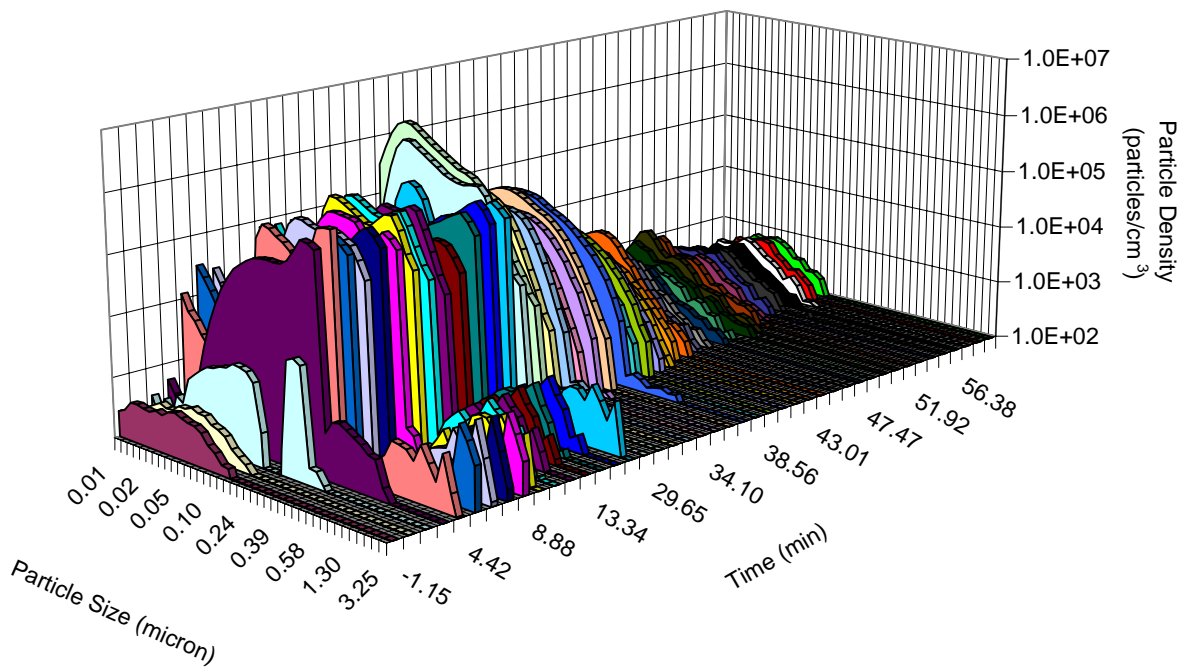


Figure 4-29: Smoke particle size distribution measured with the particle analyzer for the limited ventilation living room.

**Smoke Particle Size Distribution**

The size distribution of smoke particles in the room during the incipient fire growth phase, the first 5 minutes, was determined using the high flow bench-top cascade impactor. Results summarized in Table 4-8 corroborate the prevalence of submicron-sized particles as measured with the WPS,

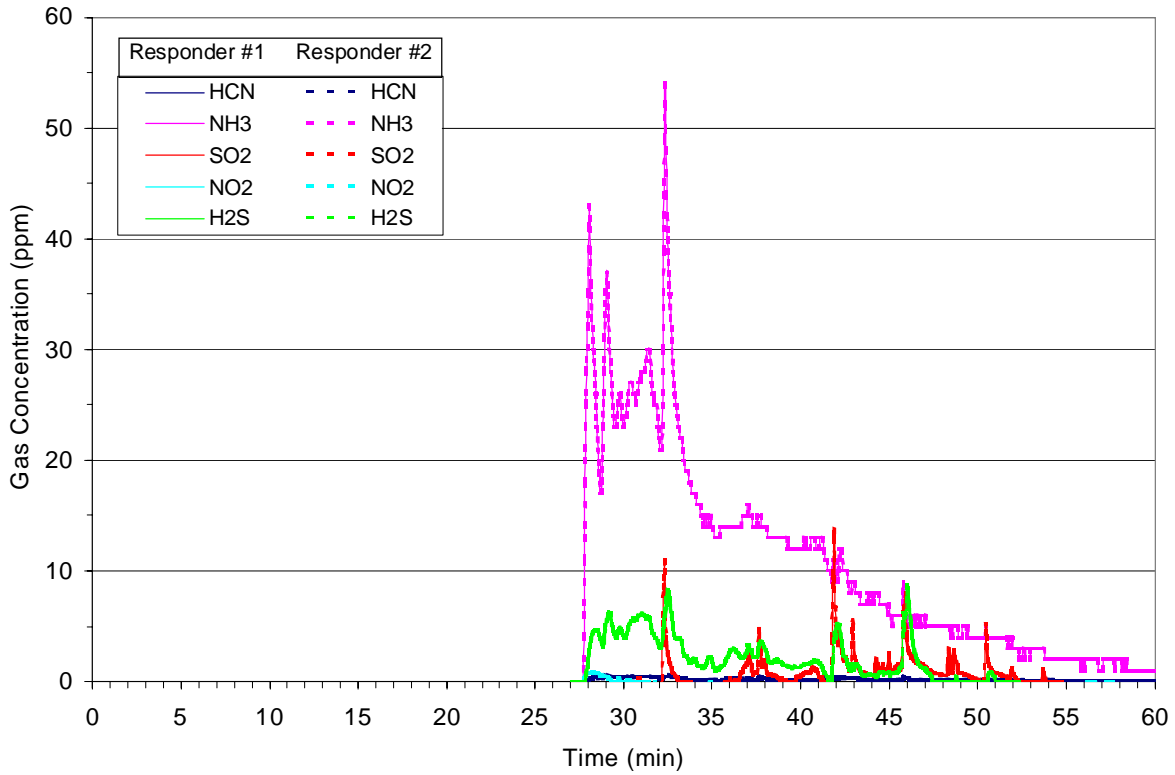
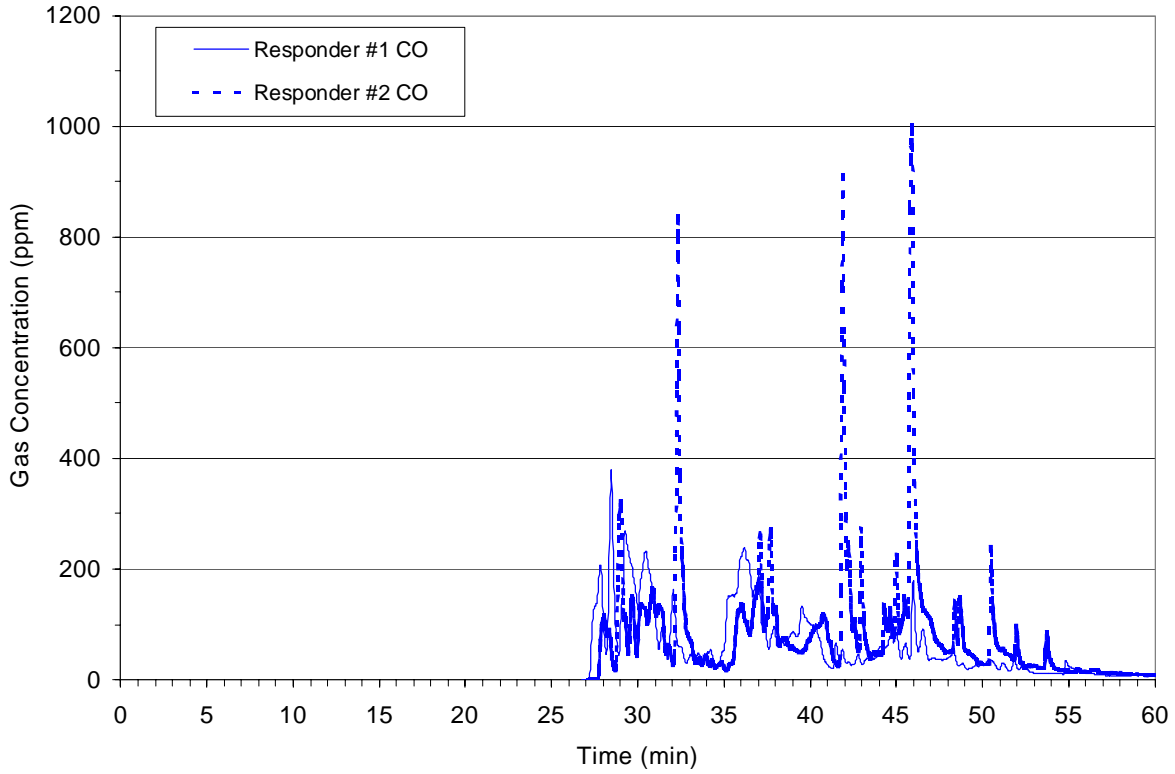
Table 4-8: Smoke particle size distribution measured by cascade impactor during the incipient fire growth phase of the limited ventilation living room fire.

| Stage No. | Cut Plate (micron) | Particulate Weight (µg) | Fraction of Collected Mass |
|-----------|--------------------|-------------------------|----------------------------|
| 1         | 10                 | 9040                    | negligible                 |
| 2         | 2.5                | 7550                    | negligible                 |
| 3         | 1                  | 21390                   | 6.27%                      |
| 4         | 0.25               | 32510                   | 9.53%                      |
| 5         | Glass fiber filter | 270540                  | 79.33%                     |

**Personal Air Sampling – Gas**

Two firefighters wore personal gas monitors and impactors during overhaul operations. Measured gas concentrations are plotted in Figure 4-30. Spikes in the personal gas concentration correspond to when the firefighters were pulling down drywall and insulation (increases in room gas concentrations were also observed for this time period by extractive FTIR).





**Figure 4-30: Gas concentrations measured by personal monitors during overhaul of the limited ventilation living room fire.**

Peak gas concentrations and calculated total exposures for the two firefighters are summarized in Table 4-9.

**Table 4-9: Summary of personal gas monitor data for overhaul of the limited ventilation living room fire.**

| Gas              | Responder #1             |                          | Responder #2             |                          |
|------------------|--------------------------|--------------------------|--------------------------|--------------------------|
|                  | Peak concentration (ppm) | Total exposure (ppm-min) | Peak concentration (ppm) | Total exposure (ppm-min) |
| HCN              | 1.7                      | 9.1                      | 0.6                      | 7.2                      |
| NH <sub>3</sub>  | 52.0                     | 364.3                    | 54.0                     | 347.6                    |
| SO <sub>2</sub>  | 2.2                      | 5.6                      | 13.8                     | 22.9                     |
| NO <sub>2</sub>  | 1.2                      | 1.1                      | 0.9                      | 1.0                      |
| H <sub>2</sub> S | 7.7                      | 44.2                     | 8.7                      | 53.1                     |
| CO               | 378.0                    | 2097.1                   | 1003.0                   | 2805.8                   |

**Personal Air Sampling – Smoke Particle Size Distribution**

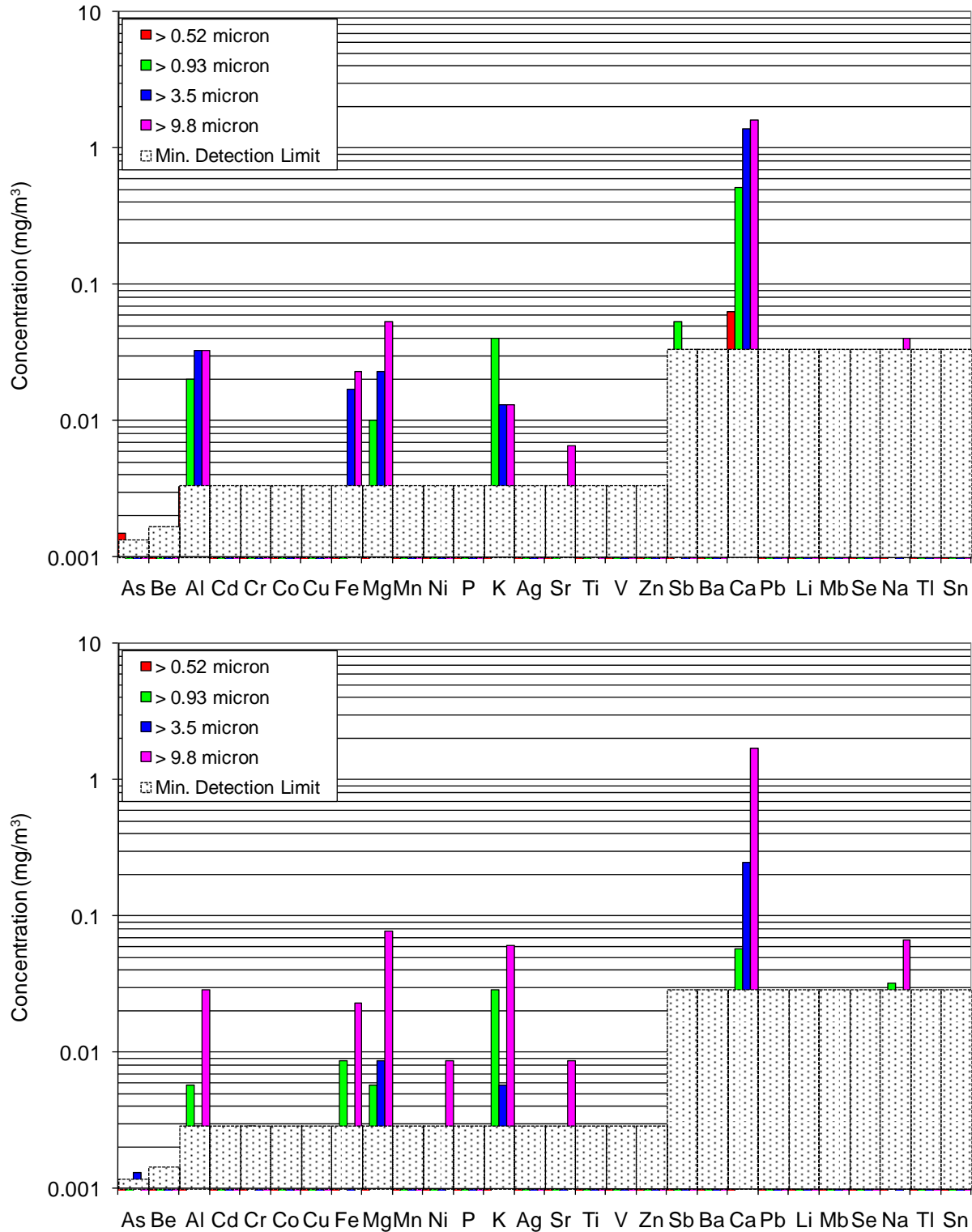
Analysis of the smoke particles accumulated on the four personal cascade impactor cut plates (0.52, 0.93, 3.5, 9.8 micron) worn by the two firefighters, Table 4-10, reveals that the relative mass distributions are similar for the two firefighters and the largest particle sizes, greater than 9.8 microns, were prevalent in both cases.

**Table 4-10: Smoke particle size distribution measured with the bench-top cascade impactor during the fire growth phase of the limited ventilation living room fire.**

| Particle Size | % Mass Fraction |                |
|---------------|-----------------|----------------|
|               | Firefighter #1  | Firefighter #2 |
| > 0.52 micron | 6.5             | 5.9            |
| > 0.93 micron | 30.4            | 22.4           |
| > 3.5 micron  | 16.4            | 13.9           |
| > 9.8 micron  | 46.7            | 57.8           |

**Personal Air Sampling – Smoke Particle Inorganic Content**

Inorganic elemental analysis of the smoke particulates collected with the personal impactor worn by the firefighters are plotted in Figure 4-31. Calcium was found to be most prevalent followed by aluminum, iron, magnesium, and potassium. Sodium, antimony (a fire retardant synergistic element), and strontium were found to a lesser degree. Arsenic was found in one particle size range for each firefighter.



**Figure 4-31: Inorganic element concentrations measured for smoke particles collected with personal cascade impactors during of the limited ventilation living room fire.**

**Effluent Gas Composition – Area Stands**

Average airborne benzene, styrene, formaldehyde, hydrogen cyanide, mercury and PAHs concentrations in the living room were determined using the collection tubes on area sampling stands. One stand was positioned to sample from the room during the first four minutes of fire growth and then from the fire vicinity for the immediately following 28 minutes. The other stand was positioned to sample from the room during the 30 minute overhaul operation period. Results for the two stands are summarized in Table 4-11.

**Table 4-11: Gas concentrations collected with area sampling stand for the limited ventilation living room fire.**

| Species                | Detection Limit (µg) | Sampling Stand: fire growth + 4 min overhaul |                            | Sampling Stand: overhaul |                            |
|------------------------|----------------------|--|----------------------------|--------------------------|----------------------------|
|                        |                      | Mass (µg)                                    | Concentration              | Mass (µg)                | Concentration              |
| Benzene                | 1.1                  | 31   | 1.4 ppm                    | 7.7                      | 0.33 ppm                   |
| Styrene                | 1.3                  | 8.2  | 0.27 ppm                   | 7.0                      | 0.23 ppm                   |
| Formaldehyde           | 0.1                  | 17   | 1.7 ppm                    | 8.7                      | 0.79 ppm                   |
| Hydrogen cyanide       | 1.0                  | 6.1  | 0.77 ppm                   | < 1.0                    | < 0.13 ppm                 |
| Mercury                | 0.0025               | 0.019  | 0.0031 mg/m <sup>3</sup>   | 0.038                    | 0.0054 mg/m <sup>3</sup>   |
| Acenaphthylene         | < 0.1                | 1.8  | 0.057 mg/m <sup>3</sup>    | 1.9                      | 0.054 mg/m <sup>3</sup>    |
| Acenaphthene           | < 0.1                | 0.15   | 0.005 mg/m <sup>3</sup>    | 0.23                     | 0.0065 mg/m <sup>3</sup>   |
| Anthracene             | < 0.1                | 0.14   | 0.0045 mg/m <sup>3</sup>   | 0.22                     | 0.0061 mg/m <sup>3</sup>   |
| Benzo(a)anthracene     | < 0.1                | < 0.1  | < 0.0039 mg/m <sup>3</sup> | < 0.1                    | < 0.0013 mg/m <sup>3</sup> |
| Benzo (a)pyrene        | < 0.1                | < 0.1  | < 0.0039 mg/m <sup>3</sup> | < 0.1                    | < 0.0013 mg/m <sup>3</sup> |
| Benzo(b)fluoranthene   | < 0.1                | < 0.1  | < 0.0039 mg/m <sup>3</sup> | < 0.1                    | < 0.0013 mg/m <sup>3</sup> |
| Benzo(k)fluoranthene   | < 0.1                | < 0.1  | < 0.0039 mg/m <sup>3</sup> | < 0.1                    | < 0.0013 mg/m <sup>3</sup> |
| Benzo(ghi)perylene     | < 0.1                | < 0.1  | < 0.0039 mg/m <sup>3</sup> | < 0.1                    | < 0.0013 mg/m <sup>3</sup> |
| Chrysene               | < 0.1                | < 0.1  | < 0.0039 mg/m <sup>3</sup> | < 0.1                    | < 0.0013 mg/m <sup>3</sup> |
| Dibenzo(a,h)anthracene | < 0.1                | < 0.1  | < 0.0039 mg/m <sup>3</sup> | < 0.1                    | < 0.0013 mg/m <sup>3</sup> |
| Fluoranthene           | < 0.1                | < 0.1  | < 0.0039 mg/m <sup>3</sup> | 0.17                     | 0.0047 mg/m <sup>3</sup>   |
| Fluorene               | < 0.1                | 0.52   | 0.017 mg/m <sup>3</sup>    | 0.4                      | 0.011 mg/m <sup>3</sup>    |
| Indeno(1,2,3-cd)pyrene | < 0.1                | < 0.1  | < 0.0039 mg/m <sup>3</sup> | < 0.1                    | < 0.0013 mg/m <sup>3</sup> |
| Naphthalene            | < 0.1                | 15   | 0.48 mg/m <sup>3</sup>     | 7.7                      | 0.22 mg/m <sup>3</sup>     |
| Phenanthrene           | < 0.1                | 1.9  | 0.06 mg/m <sup>3</sup>     | 1.1                      | 0.03 mg/m <sup>3</sup>     |
| Pyrene                 | < 0.1                | < 0.1  | < 0.0039 mg/m <sup>3</sup> | 0.28                     | 0.0078 mg/m <sup>3</sup>   |

### 4.3.3 Bedroom

Following ignition of the candle, the candle flame ignited the basket of potpourri and newspapers on the dresser and then propagated to the curtains, bedding, floor, and other room furnishings. Flashover of the room occurred 5:27 minutes after candle ignition. The ionization smoke alarm activated 38 seconds after candle ignition and the photoelectric smoke alarm followed 2 minutes later. The carbon monoxide alarm activated 4:52 minutes after candle ignition, which was only 35 seconds prior to flashover.

#### Heat and Smoke Release Rates

Graphs of the heat and smoke release rates for the bedroom fire scenario are shown in Figure 4-32 and Figure 4-33 respectively. For the first 4 minutes of the fire the heat release rate was less than 100 kW. Within 1½ minutes the fire grew to flashover with a HRR of approximately 4 MW and continued to grow at that rate to 5.8 MW before suppression was started. Correspondingly virtually no smoke was detected with the calorimeter hood for the first 4 minutes after which it rapidly grew to almost 12.5 m<sup>2</sup>/s by flashover and continued to increase to more than 31 m<sup>2</sup>/s before suppression was started.

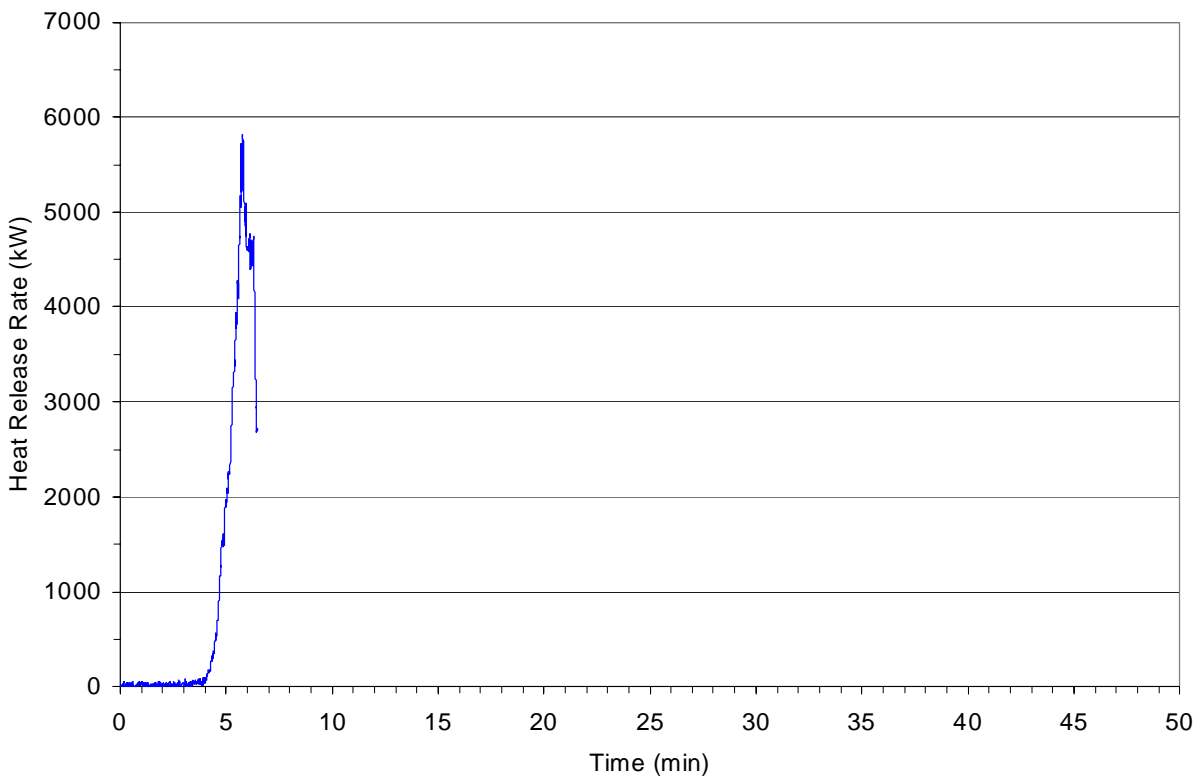
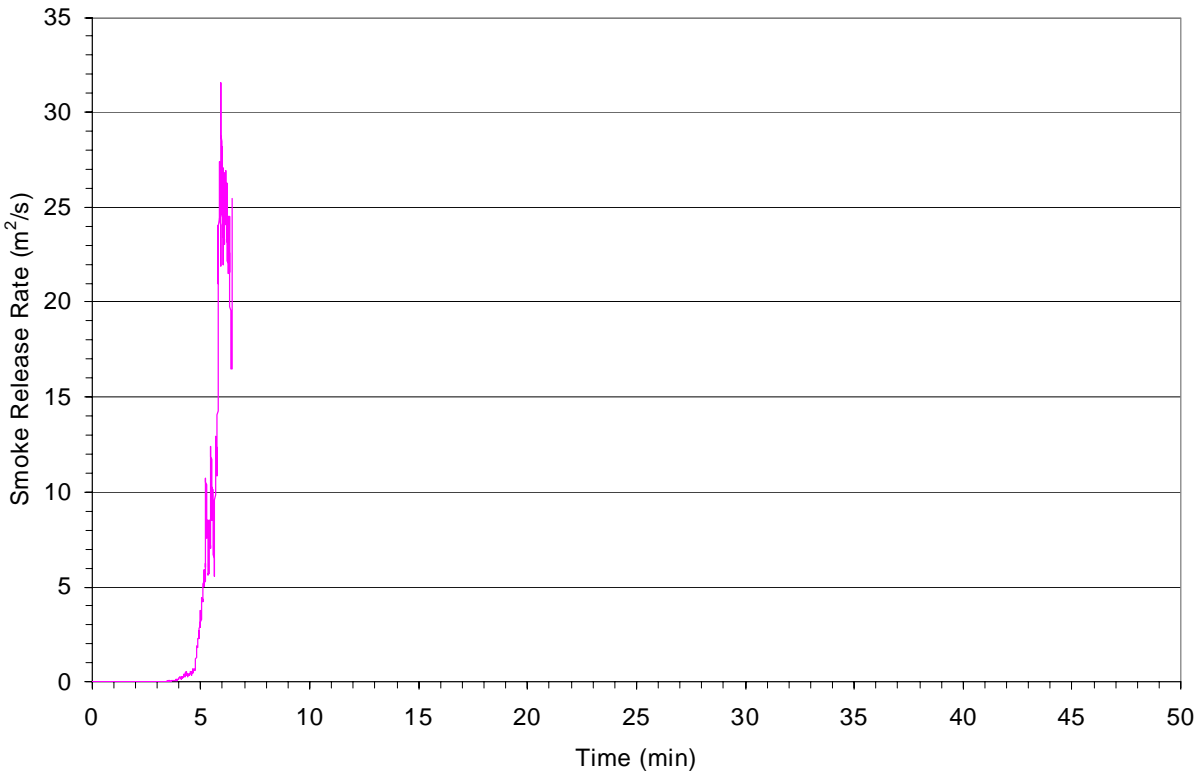


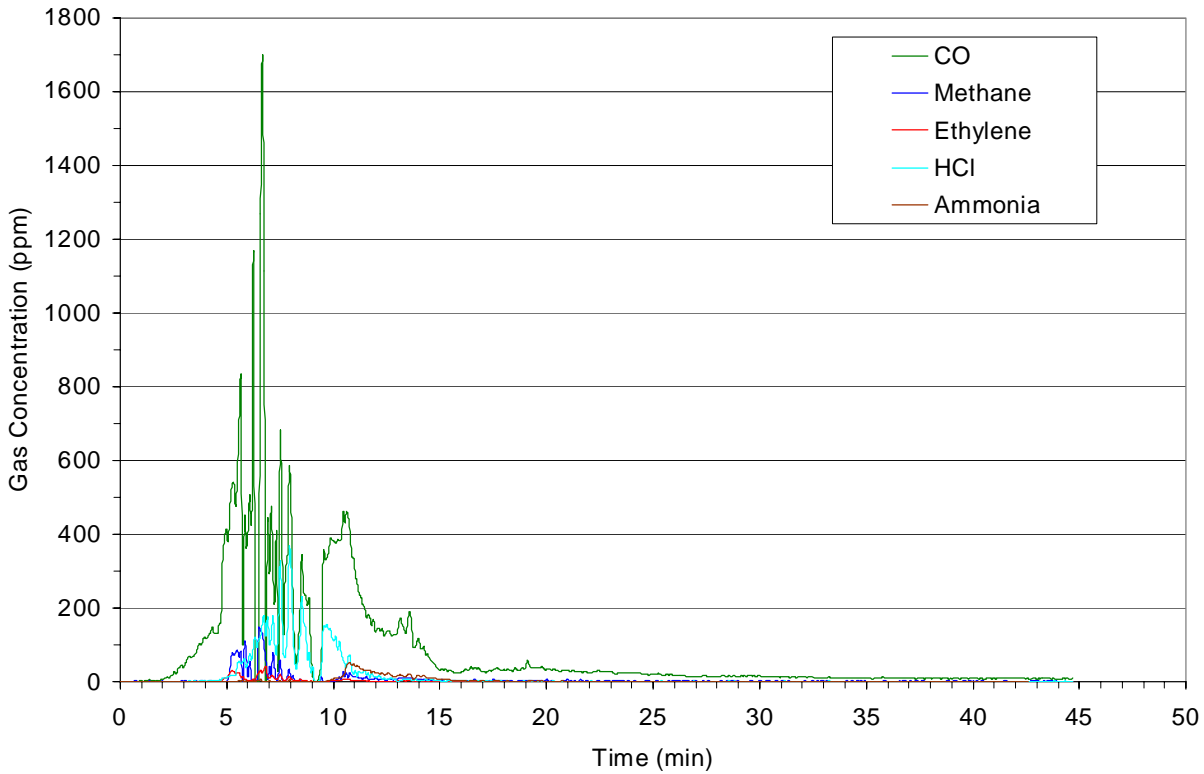
Figure 4-32: Heat release rate during the fire growth phase of the bedroom fire.



**Figure 4-33: Smoke release rate during the fire growth phase of the bedroom fire.**

### **Effluent Gas Composition – OP-FTIR**

Concentrations of gases escaping the bedroom doorway were measured by OP-FTIR for the duration of the fire test. Results for gases other than water and carbon dioxide are plotted in Figure 4-34. Note the rapid rise in gas concentrations corresponding to the same time frames as the rise in heat and smoke release rates. At the time of flashover, carbon monoxide concentration was approximately 530 ppm, methane was 75 ppm, ethylene was 30 ppm, and hydrogen chloride gas was 18 ppm; ammonia was not detected. During the suppression testing phase gas concentrations were erratic depending on whether water was being applied or the fire was being allowed to grow. At the end of suppression the carbon monoxide concentration was approximately 175 ppm, methane was 13 ppm, ethylene was less than 2 ppm, and hydrogen chloride gas was 19 ppm, ammonia concentration was approximately 31 ppm however. Within 3½ minutes of commencing overhaul (15 minutes after ignition), gas concentrations decreased by an 4 to 10X.



**Figure 4-34: Gas concentration measured by OP-FTIR for the bedroom fire.**

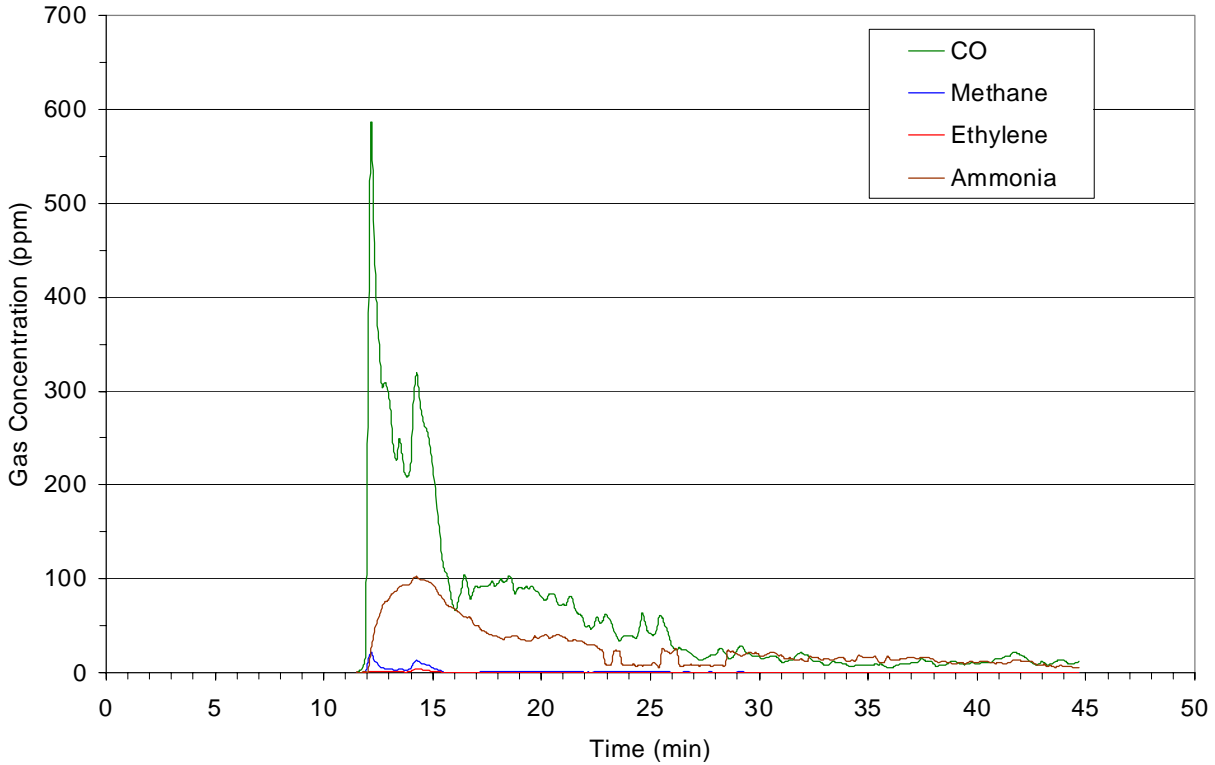
Peak gas concentrations and calculated total exposures are summarized in Table 4-12.

**Table 4-12: Summary of OP-FTIR gas concentration data for the bedroom fire.**

| Gas      | Peak concentration (ppm) | Total exposure (ppm-min) |
|----------|--------------------------|--------------------------|
| CO       | 1695.9                   | 3606.2                   |
| Methane  | 146.7                    | 246.5                    |
| Ethylene | 42.6                     | 72.4                     |
| HCl      | 362.8                    | 661.4                    |
| Ammonia  | 53.0                     | 143.9                    |

**Effluent Gas Composition – Extractive FTIR**

Concentrations of gases in the bedroom area were measured during overhaul by extractive FTIR. Results for gases other than water and carbon dioxide are plotted in Figure 4-35. Gas concentrations at the start of overhaul were approximately 580 ppm for carbon monoxide, 21 ppm for methane, 2 ppm for ethylene, and 24 ppm for ammonia. Within 2 minutes of commencing overhaul, carbon monoxide and methane concentrations decreased by a factor of 2. Ammonia concentration increased by a factor of 4 however and did not decrease back to 20 ppm for more than 10 minutes. Four minutes after overhaul commenced, carbon monoxide concentration dropped below 100 ppm.



**Figure 4-35: Gas concentration measured by extractive FTIR during overhaul of the bedroom fire.**

Peak gas concentrations and calculated total exposures are summarized in Table 4-13.

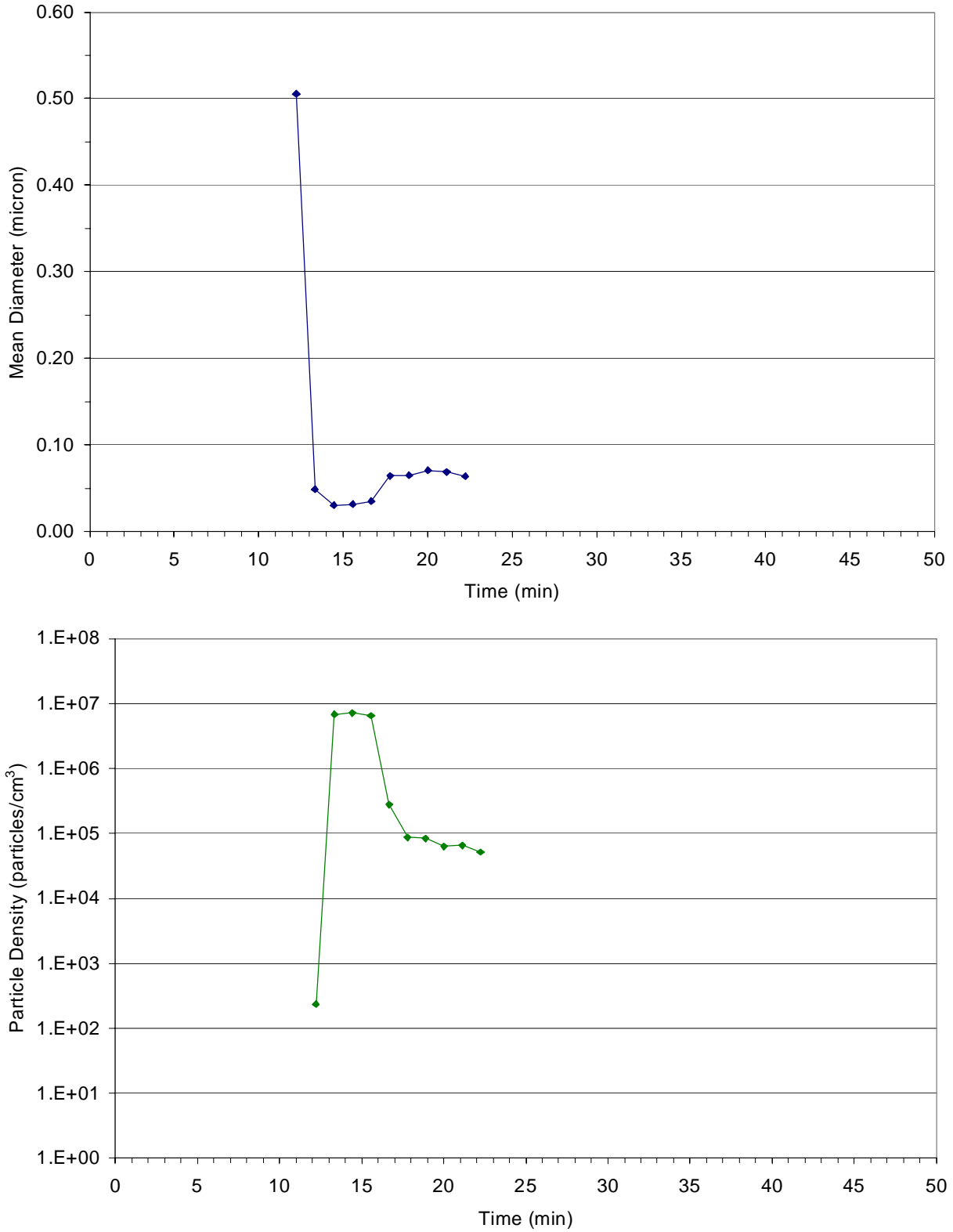
**Table 4-13: Summary of extractive FTIR gas concentration data for overhaul of the bedroom fire.**

| Gas      | Peak concentration (ppm) | Total exposure (ppm-min) |
|----------|--------------------------|--------------------------|
| CO       | 580.2                    | 1985.4                   |
| Methane  | 21.8                     | 45.8                     |
| Ethylene | 4.8                      | 8.4                      |
| Ammonia  | 102.6                    | 886.4                    |

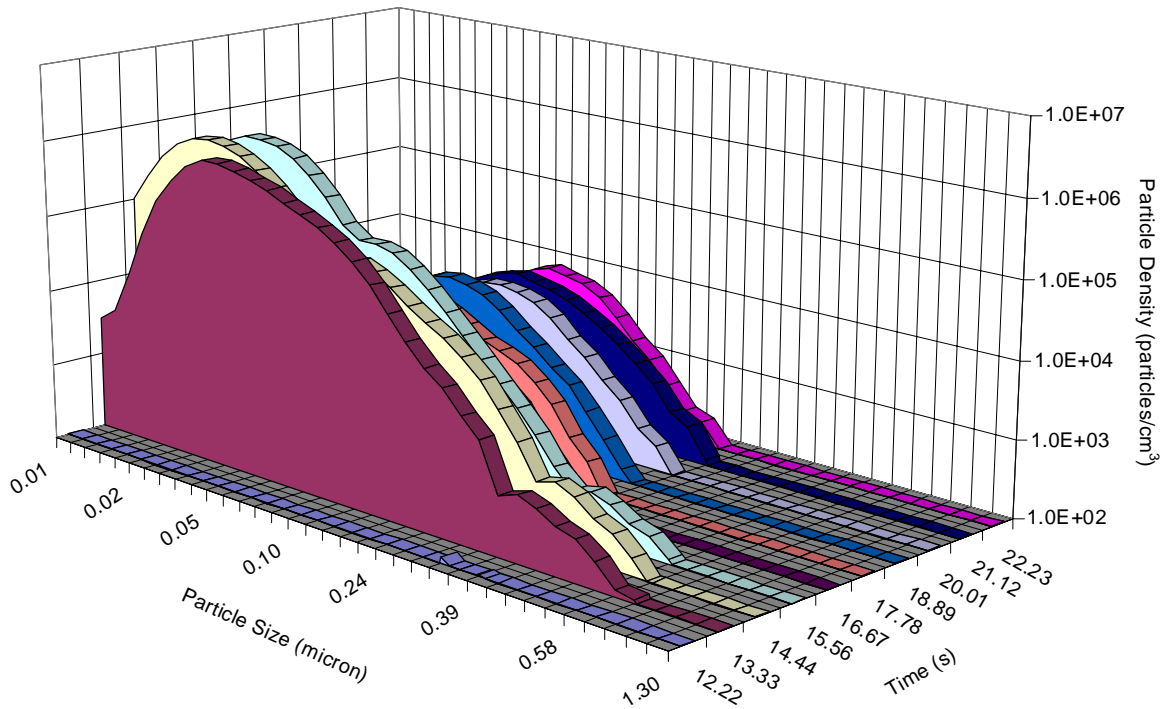
### Smoke Particle Analyzer

The average smoke particle size and particle count density as characterized with the WPS spectrometer for overhaul is depicted in Figure 4-36. Despite the variety of activity occurring during overhaul, the average smoke particle size remains fairly consistent after the first minute at  $0.053 \pm 0.017$  microns. The particle count density however undergoes a two order reduction during the first 5 minutes of overhaul to stabilize at  $70,400 \pm 15,100$  particles per cubic centimeter. As seen in the plot of the particle size distribution, Figure 4-37, particles measuring less than 0.32 microns were the most prevalent.





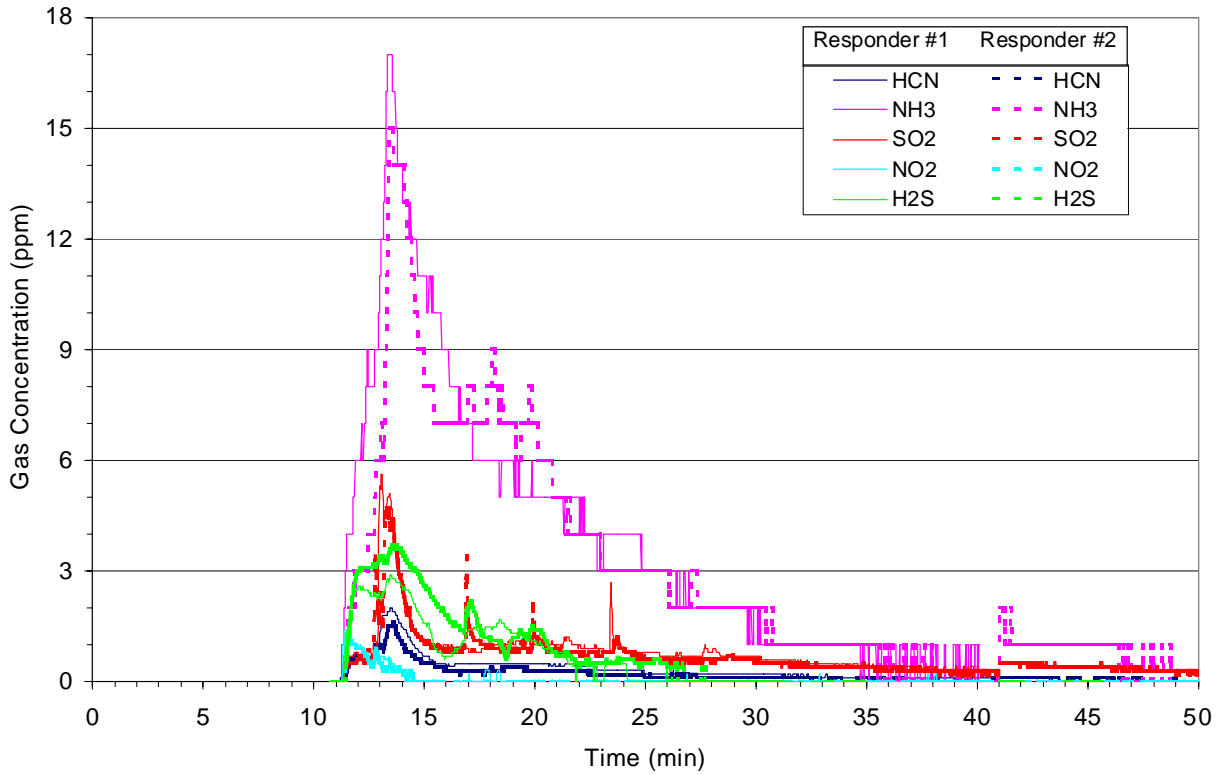
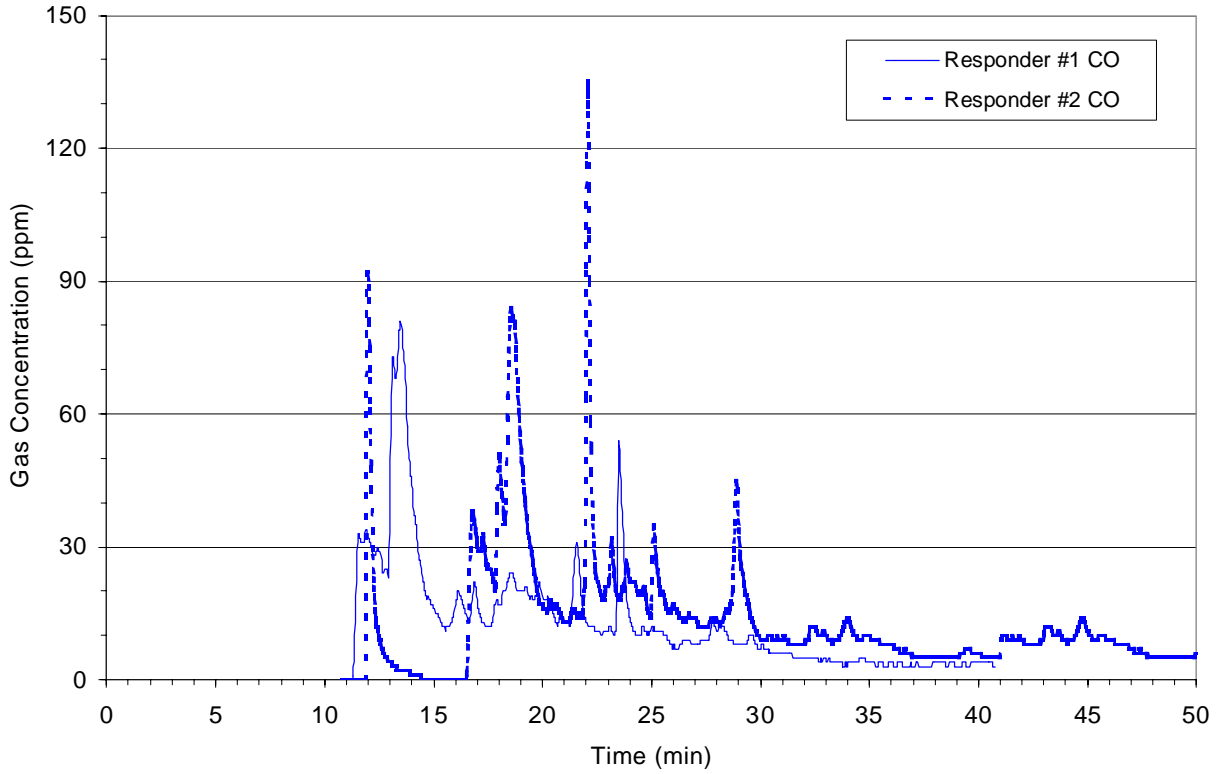
**Figure 4-36: Smoke particle average size (top) and count density (bottom) measured with the particle analyzer during overhaul of the bedroom fire.**



**Figure 4-37: Smoke particle size distribution measured with the particle analyzer during overhaul of the bedroom fire.**

**Personal Air Sampling – Gas**

Two firefighters wore personal gas monitors and impactors during overhaul operations. Measured gas concentrations are plotted in Figure 4-38. Spikes in the personal gas concentration correspond to when the firefighters were pulling down drywall and insulation (increases in room gas concentrations were also observed for this time period by extractive FTIR).



**Figure 4-38: Gas concentrations measured by personal monitors during overhaul of the bedroom fire.**

Peak gas concentrations and calculated total exposures for the two firefighters are summarized in Table 4-14.

**Table 4-14: Summary of personal gas monitor data for overhaul of the bedroom fire.**

| Gas              | Responder #1             |                          | Responder #2             |                          |
|------------------|--------------------------|--------------------------|--------------------------|--------------------------|
|                  | Peak concentration (ppm) | Total exposure (ppm-min) | Peak concentration (ppm) | Total exposure (ppm-min) |
| HCN              | 2.0                      | 10.6                     | 1.6                      | 7.4                      |
| NH <sub>3</sub>  | 17.0                     | 113.3                    | 15.0                     | 109.0                    |
| SO <sub>2</sub>  | 5.6                      | 25.5                     | 4.7                      | 26.4                     |
| NO <sub>2</sub>  | 1.4                      | 2.3                      | 1.3                      | 1.8                      |
| H <sub>2</sub> S | 2.9                      | 17.0                     | 3.7                      | 22.5                     |
| CO               | 81.0                     | 396.0                    | 135.0                    | 531.3                    |

### Personal Air Sampling – Smoke Particle Size Distribution

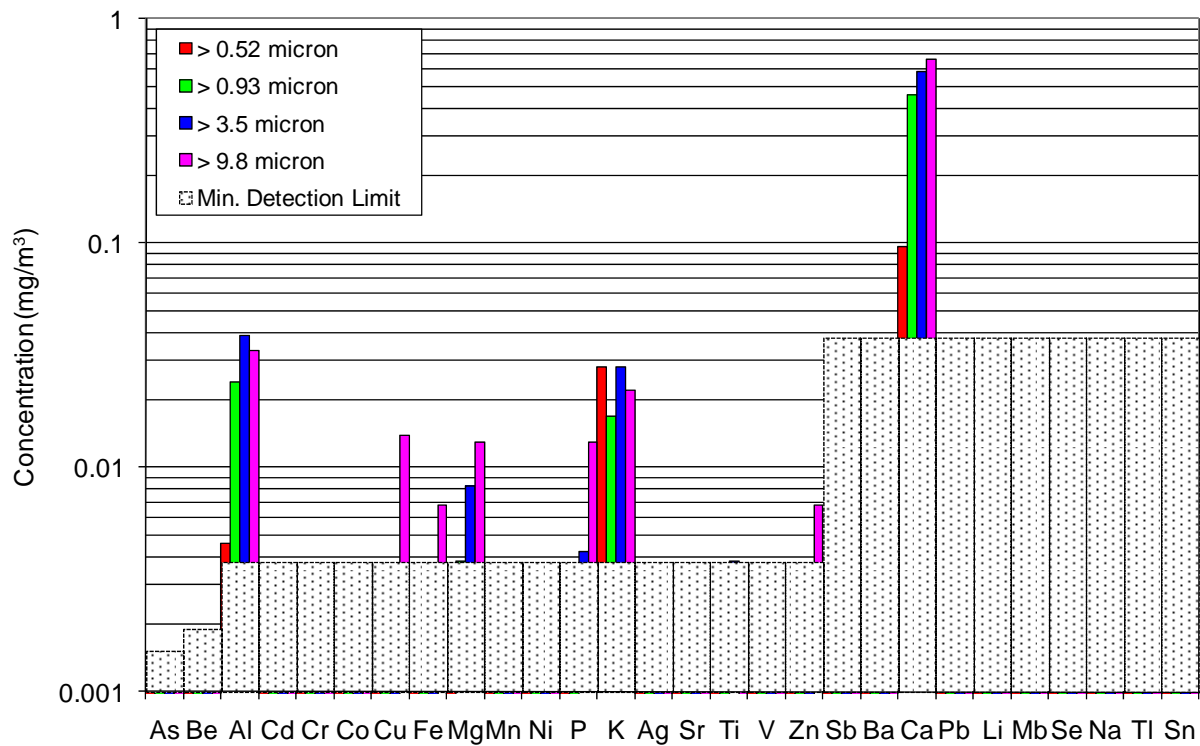
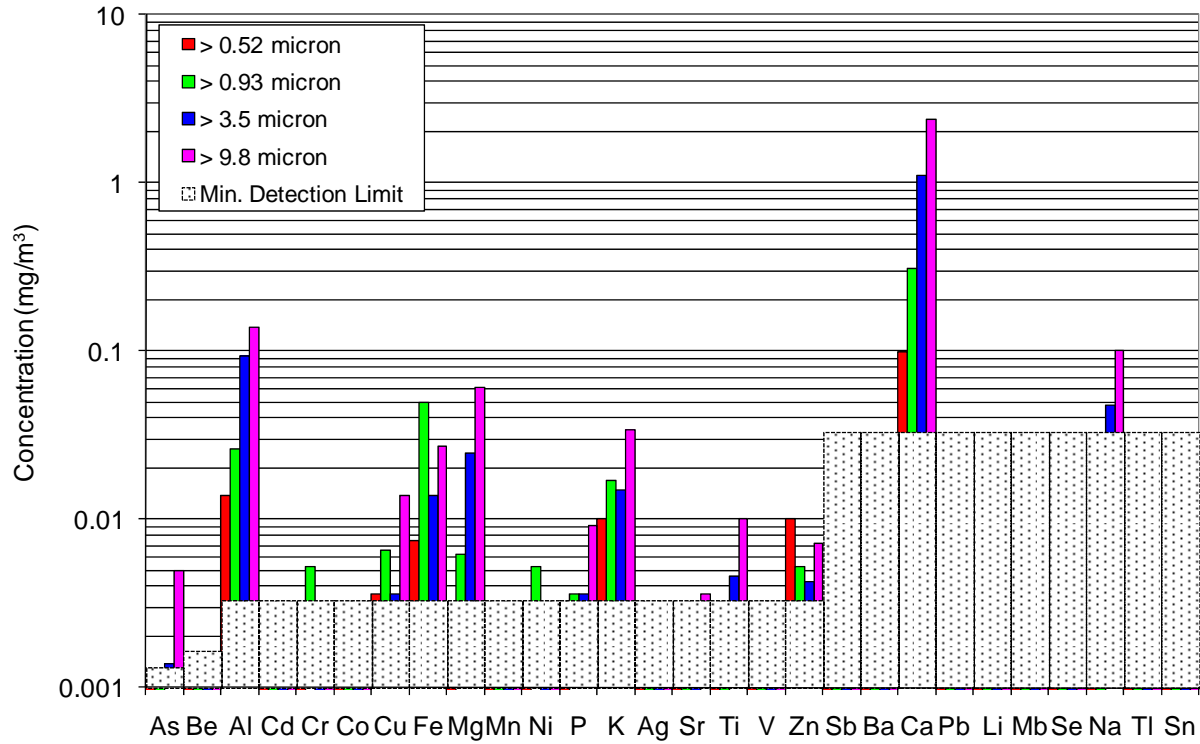
Analysis of the smoke particles accumulated on the four personal cascade impactor cut plates (0.52, 0.93, 3.5, 9.8 micron) worn by the two firefighters, Table 4-15, reveals that the relative mass distributions of the two smaller size ranges are similar for the two firefighters but the ratio of larger particle sizes differs. This difference may be a result of firefighter #1 spending considerably more time handling the dresser on which the fire originated. In both cases though particles greater than 3.5 microns dominate the distribution.

**Table 4-15: Mass distribution of smoke particles collected on personal cascade impactors during overhaul of the bedroom fire.**

| Particle Size | % Mass Fraction |                |
|---------------|-----------------|----------------|
|               | Firefighter #1  | Firefighter #2 |
| > 0.52 micron | 2.3             | 6.9            |
| > 0.93 micron | 2.1             | 7.6            |
| > 3.5 micron  | 25.5            | 44.4           |
| > 9.8 micron  | 70.1            | 41.1           |

### Personal Air Sampling – Smoke Particle Inorganic Content

Inorganic elemental analysis of the smoke particulates collected with the personal impactor worn by the firefighters are plotted in Figure 4-39. Calcium was found to be most prevalent followed by aluminum, iron, magnesium, and potassium. Chromium, copper, nickel, phosphor, sodium, strontium, titanium, and zinc were found to a lesser degree. Arsenic was also found in two particle size ranges for one of the firefighters.



**Figure 4-39: Inorganic element concentrations measured for smoke particles collected with personal cascade impactors during overhaul of the bedroom fire.**

**Effluent Gas Composition – Area Stands**

Average airborne benzene, styrene, and formaldehyde concentrations in the bedroom were determined using the collection tubes on an area sampling stand. Results for the stand is summarized in Table 4-16.

**Table 4-16: Gas concentrations collected with area sampling stand during overhaul of the bedroom fire.**

| <b>Species</b> | <b>Detection Limit<br/>(<math>\mu\text{g}</math>)</b> | <b>Mass<br/>(<math>\mu\text{g}</math>)</b> | <b>Concentration</b> |
|----------------|---|--|----------------------|
| Benzene        | 1.0   | 2.4  | 0.12 ppm             |
| Styrene        | 1.2   | 7.2  | 0.26 ppm             |
| Formaldehyde   | 0.1   | 2.7  | 0.28 ppm             |

#### 4.3.4 Kitchen

Following ignition of the candle, the candle flame ignited the paper towels, the coffee maker, the wood cabinets and continued to propagate to the other room furnishings. Flashover of the room occurred 9:59 minutes after candle ignition. The ionization smoke alarm activated 26 seconds after candle ignition and the photoelectric smoke alarm followed 1:32 minutes later. The carbon monoxide alarm activated 3:42 minutes after candle ignition, which was more than 3 minutes after the ionization alarm.

#### Heat and Smoke Release Rates

Graphs of the heat and smoke release rates for the living room fire scenario are shown in Figure 4-40 and Figure 4-41 respectively. For the first seven minutes of the fire the heat release rate was relatively low, around 200 kW. Within the next three minutes the fire grew to flashover with a HRR of approximately 3 MW and continued to grow at that rate to more than 8 MW before suppression was started. Correspondingly virtually no smoke was detected with the calorimeter hood for the first 8 minutes and then rapidly grew to approximately  $4 \text{ m}^2/\text{s}$  by flashover, and continued to increase to more than  $17 \text{ m}^2/\text{s}$  before suppression was started.

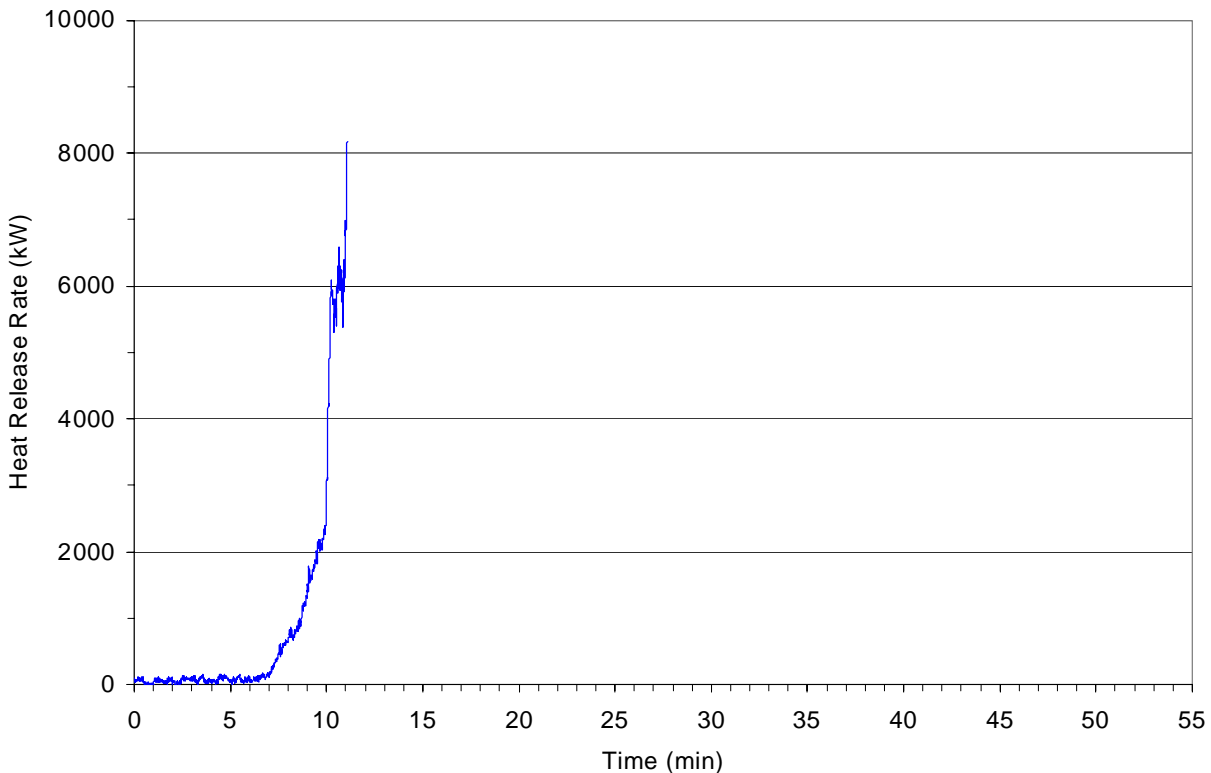
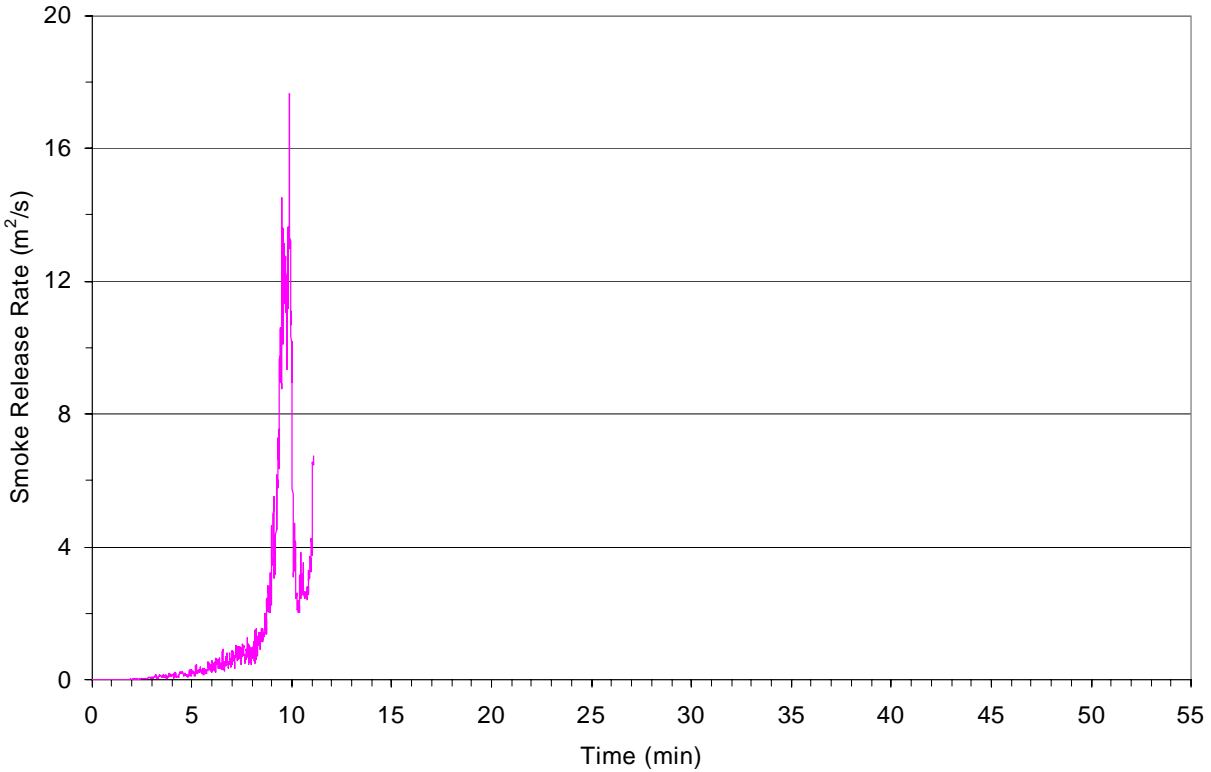


Figure 4-40: Heat release rate during the fire growth phase of the kitchen fire.



**Figure 4-41: Smoke release rate during the fire growth phase of the kitchen fire.**

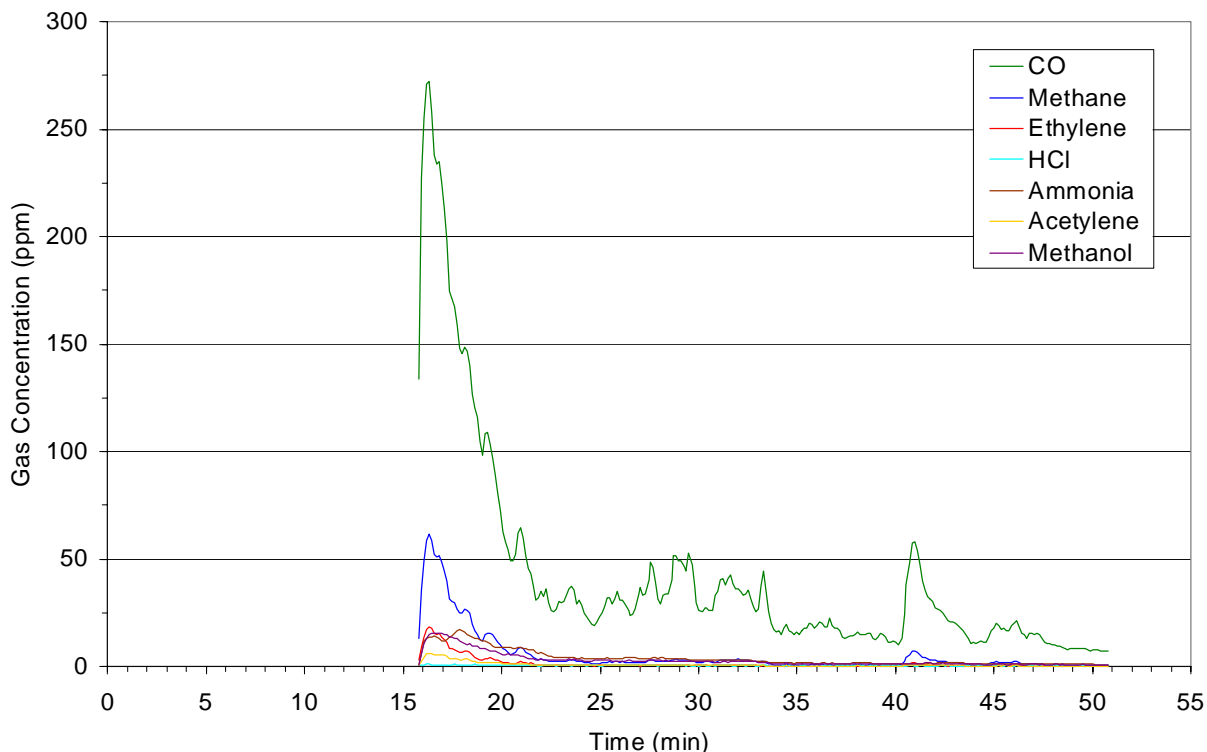
#### **Effluent Gas Composition – OP-FTIR**

Electrical noise interference on the circuit being used to operate the OP-FTIR compromised the signal-to-noise quality of the data to a point that the data was found to be meaningless.

#### **Effluent Gas Composition – Extractive FTIR**

Concentrations of gases in the kitchen area were measured during overhaul by extractive FTIR. Results for gases other than water and carbon dioxide are plotted in Figure 4-42. Gas concentrations at the start of overhaul were approximately 270 ppm for carbon monoxide, 61 ppm for methane, 18 ppm for ethylene, 14 ppm for ammonia and methanol, 6 ppm for acetylene, and 1 ppm hydrogen chloride gas. Within 5 minutes however concentrations decreased by 5 to 10X. Gas concentrations stabilized after approximately ten minutes of overhaul with carbon monoxide ranging between 15 and 50 ppm and the other gases at less than 5 ppm.





**Figure 4-42: Gas concentration measured by extractive FTIR during overhaul of the kitchen fire.**

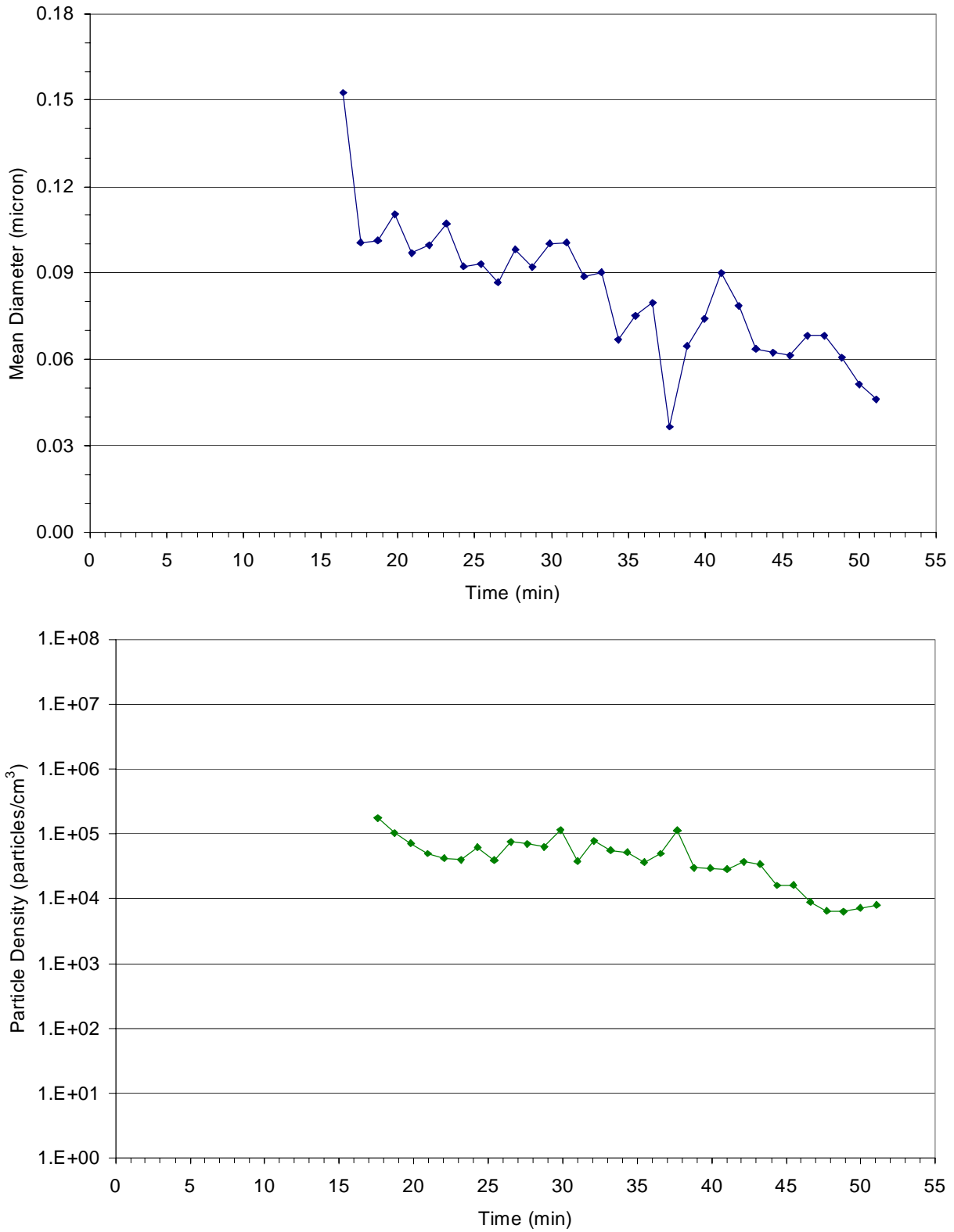
Peak gas concentrations and calculated total exposures are summarized in Table 4-17.

**Table 4-17: Summary of extractive FTIR gas concentration data for overhaul of the kitchen fire.**

| Gas       | Peak concentration (ppm) | Total exposure (ppm-min) |
|-----------|--------------------------|--------------------------|
| CO        | 272.1                    | 1465.4                   |
| Methane   | 61.5                     | 189.3                    |
| Ethylene  | 18.5                     | 48.3                     |
| HCl       | 1.0                      | 15.2                     |
| Ammonia   | 17.1                     | 132.2                    |
| Acetylene | 6.2                      | 27.8                     |
| Methanol  | 15.5                     | 103.5                    |

### Smoke Particle Analyzer

The average smoke particle size and particle count density as characterized with the WPS spectrometer for overhaul is depicted in Figure 4-43. The average smoke particle size steadily decreased from 0.10 microns to 0.05 microns throughout the 30 minute overhaul period. The particle count density correspondingly undergoes a 1½ order reduction during the same time period to stabilize around 7,000 particles per cubic centimeter. As seen in the plot of the particle size distribution, Figure 4-44, particles measuring less than 0.32 microns were the most prevalent.



**Figure 4-43: Smoke particle average size (top) and count density (bottom) measured with the particle analyzer during overhaul of the kitchen fire.**

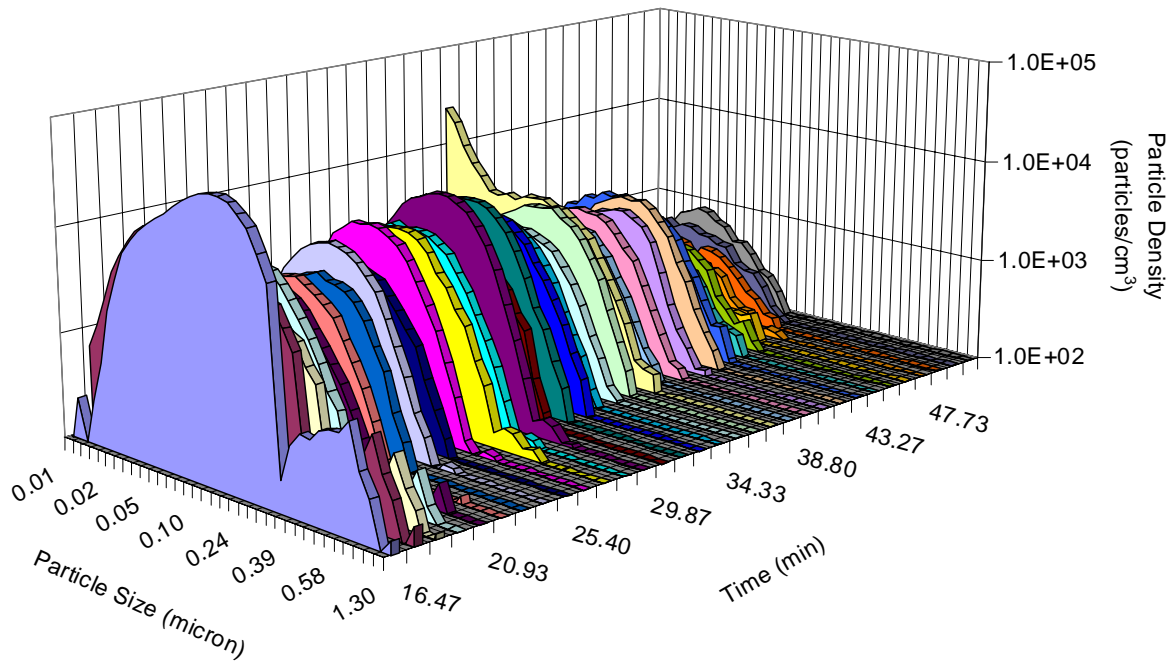


Figure 4-44: Smoke particle size distribution measured with the particle analyzer during overhaul of the kitchen fire.

**Smoke Particle Size Distribution**

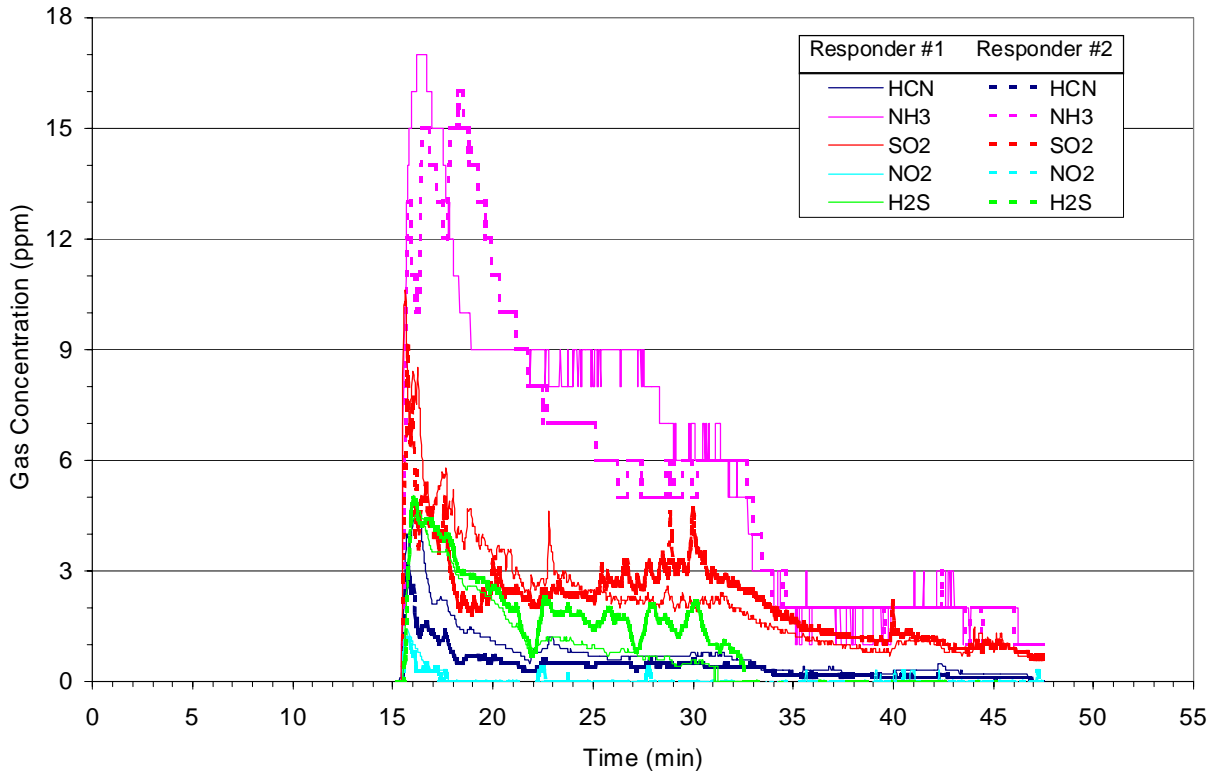
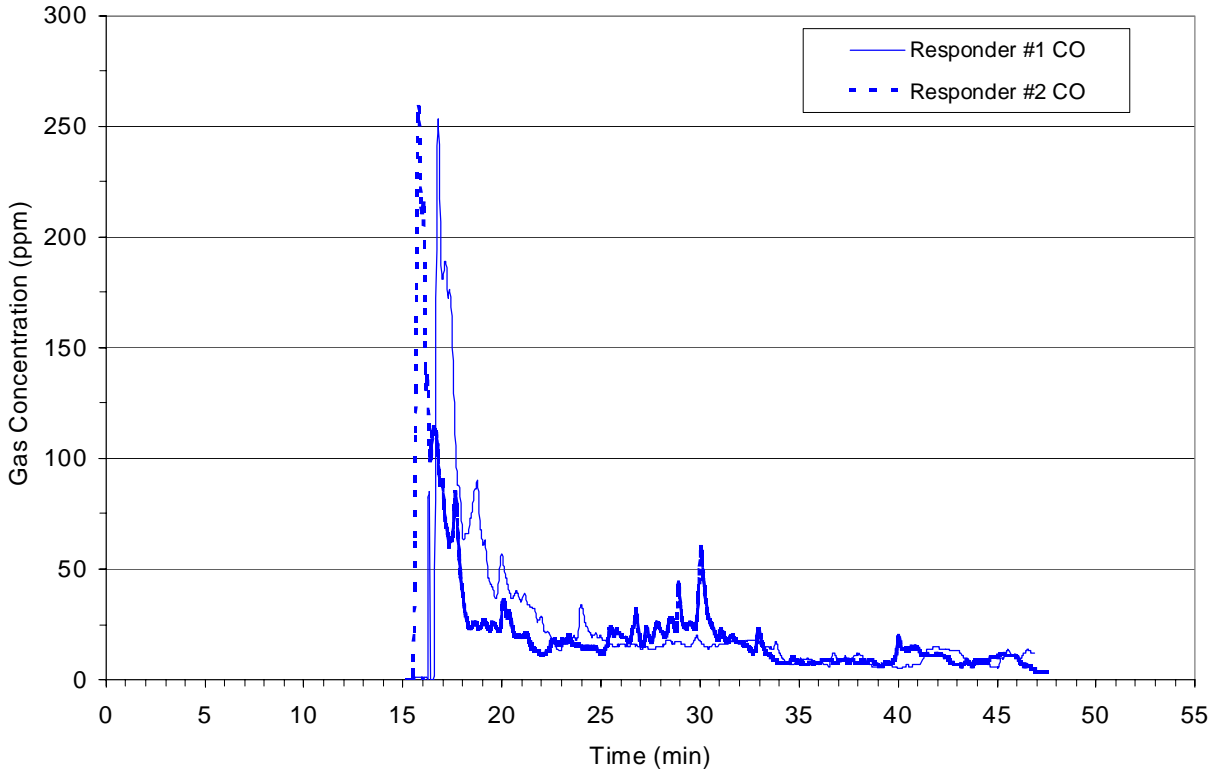
The size distribution of smoke particles in the room during the fire growth phase was determined using the high flow bench-top cascade impactor. Results summarized in Table 4-18 corroborate the prevalence of submicron-sized particles as measured with the WPS,

Table 4-18: Smoke particle size distribution measured with the bench-top cascade impactor during the fire growth phase of the kitchen fire.

| Stage No. | Cut Plate (micron) | Particulate Weight (µg) | Fraction of Collected Mass |
|-----------|--------------------|-------------------------|----------------------------|
| 1         | 10                 | < 100                   | negligible                 |
| 2         | 2.5                | 440                     | 0.39%                      |
| 3         | 1                  | < 100                   | negligible                 |
| 4         | 0.25               | 2990                    | 2.63%                      |
| 5         | Glass fiber filter | 110410                  | 96.99%                     |

**Personal Air Sampling – Gas**

Two firefighters wore personal gas monitors and impactors during overhaul operations. Measured gas concentrations are plotted in Figure 4-45. Spikes in the personal gas concentration correspond to when the firefighters were pulling down drywall and insulation (increases in room gas concentrations were also observed for this time period by extractive FTIR).



**Figure 4-45: Gas concentrations measured by personal monitors during overhaul of the kitchen fire.**

Peak gas concentrations and calculated total exposures for the two firefighters are summarized in Table 4-19.

**Table 4-19: Summary of personal gas monitor data for overhaul of the kitchen fire.**

| Gas              | Responder #1             |                          | Responder #2             |                          |
|------------------|--------------------------|--------------------------|--------------------------|--------------------------|
|                  | Peak concentration (ppm) | Total exposure (ppm-min) | Peak concentration (ppm) | Total exposure (ppm-min) |
| HCN              | 4.6                      | 23.5                     | 3.2                      | 13.2                     |
| NH <sub>3</sub>  | 17.0                     | 183.9                    | 16.0                     | 174.0                    |
| SO <sub>2</sub>  | 10.6                     | 70.1                     | 9.1                      | 69.6                     |
| NO <sub>2</sub>  | 1.4                      | 1.6                      | 1.2                      | 1.2                      |
| H <sub>2</sub> S | 4.7                      | 24.5                     | 5.0                      | 35.2                     |
| CO               | 253                      | 748.2                    | 259.0                    | 722.4                    |

### Personal Air Sampling – Smoke Particle Size Distribution

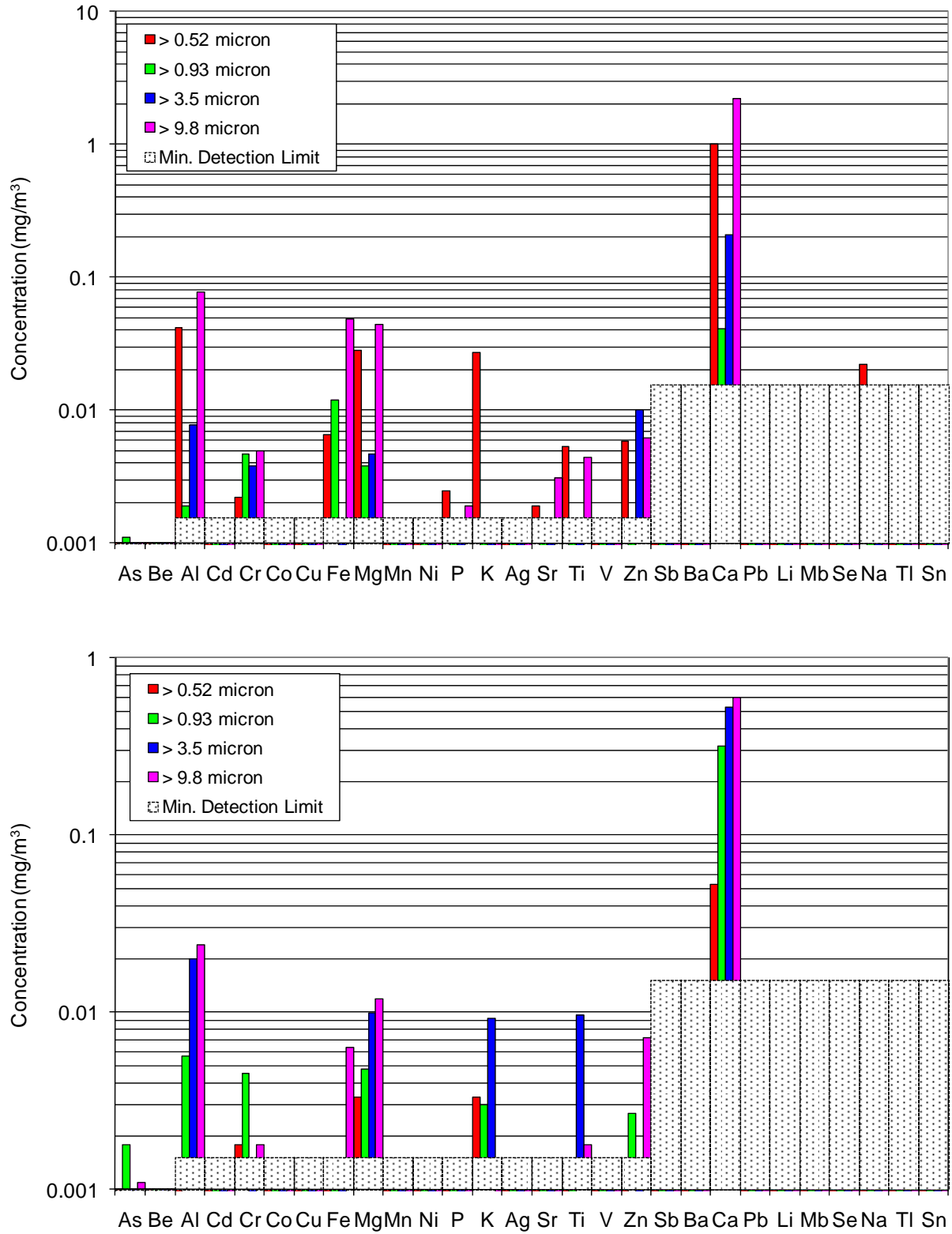
Analysis of the smoke particles accumulated on the four personal cascade impactor cut plates (0.52, 0.93, 3.5, 9.8 micron) worn by the two firefighters, Table 4-20, reveals that the relative mass distributions are similar for the two firefighters and the largest particle sizes, greater than 9.8 microns, were prevalent in both cases.

**Table 4-20: Mass distribution of smoke particles collected on personal cascade impactors during overhaul of the kitchen fire.**

| Particle Size | % Mass Fraction |                |
|---------------|-----------------|----------------|
|               | Firefighter #1  | Firefighter #2 |
| > 0.52 micron | 0.7             | 3.2            |
| > 0.93 micron | 8.7             | 14.7           |
| > 3.5 micron  | 22.0            | 29.5           |
| > 9.8 micron  | 68.6            | 52.6           |

### Personal Air Sampling – Smoke Particle Inorganic Content

Inorganic elemental analysis of the smoke particulates collected with the personal impactor worn by the firefighters are plotted in Figure 4-46. Calcium was found to be most prevalent followed by aluminum, iron, magnesium, and potassium. Chromium, copper, nickel, phosphor, sodium, strontium, titanium, and zinc were found to a lesser degree. Arsenic was also found in particles collected for both firefighters.



**Figure 4-46: Inorganic element concentrations measured for smoke particles collected with personal cascade impactors during overhaul of the kitchen fire.**

**Effluent Gas Composition – Area Stands**

Average airborne benzene, styrene, formaldehyde, and mercury concentrations in the kitchen were determined using the collection tubes on an area sampling stand. Results for the stand are summarized in Table 4-21.

**Table 4-21: Gas concentrations collected with area sampling stand during overhaul of the kitchen fire.**

| <b>Species</b> | <b>Detection Limit<br/>(<math>\mu\text{g}</math>)</b> | <b>Mass<br/>(<math>\mu\text{g}</math>)</b> | <b>Concentration</b>    |
|----------------|---|--|-------------------------|
| Benzene        | 1.0   | 2.4  | 0.12 ppm                |
| Styrene        | 1.2   | 7.2  | 0.26 ppm                |
| Formaldehyde   | 0.1   | 2.7  | 0.28 ppm                |
| Mercury        | 0.0025  | 0.013                                      | 0.002 mg/m <sup>3</sup> |

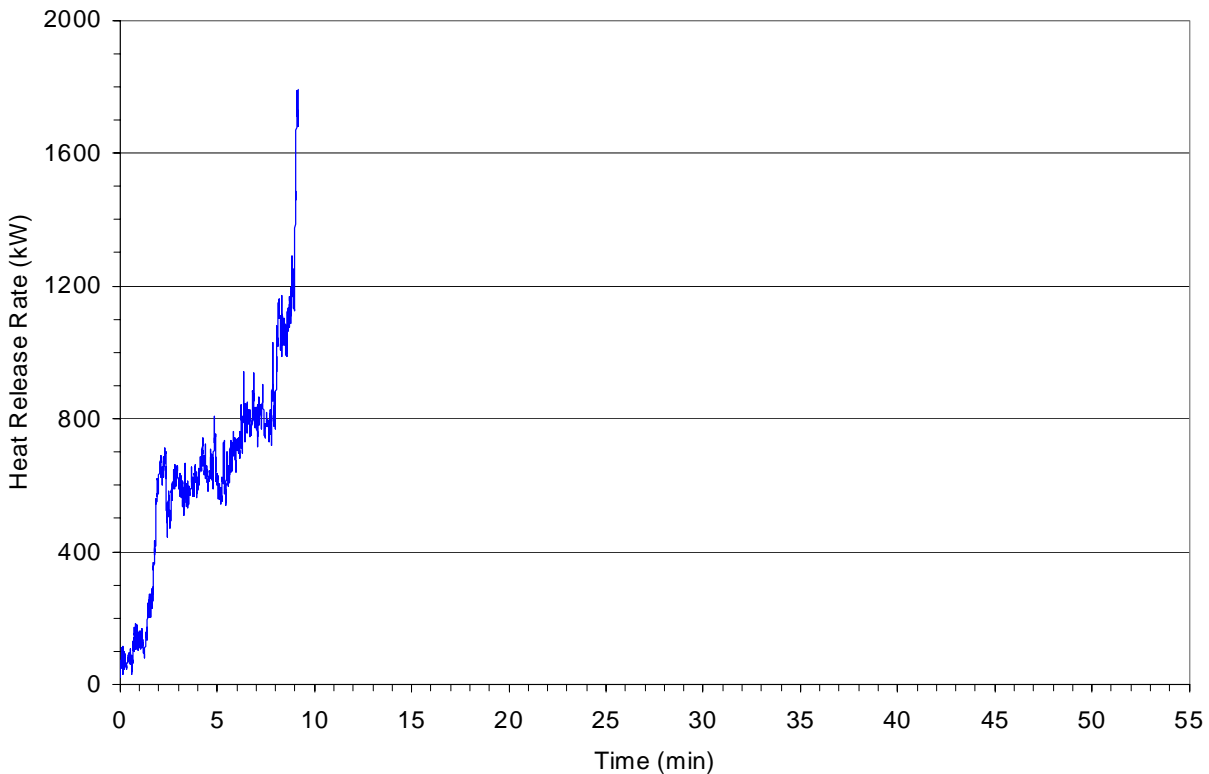
### 4.3.5 Attic

Following ignition of the candle, the candle flame ignited the adjacent newspapers and books and then propagated to the other room furnishings. Flames extended out of the attic window 8:01 minutes after candle ignition. The attic roof trap door was opened 54 seconds after the flames extended out the window and suppression commenced 17 seconds later.

Neither smoke alarm, located in the room below the attic space, activated prior to commencement of suppression. The photoelectric and ionization smoke alarms activated 39 seconds and 2:15 minutes after suppression commenced respectively. It is unclear if the alarms activated due to smoke concentration or water from suppression. The carbon monoxide alarm never triggered throughout the test.

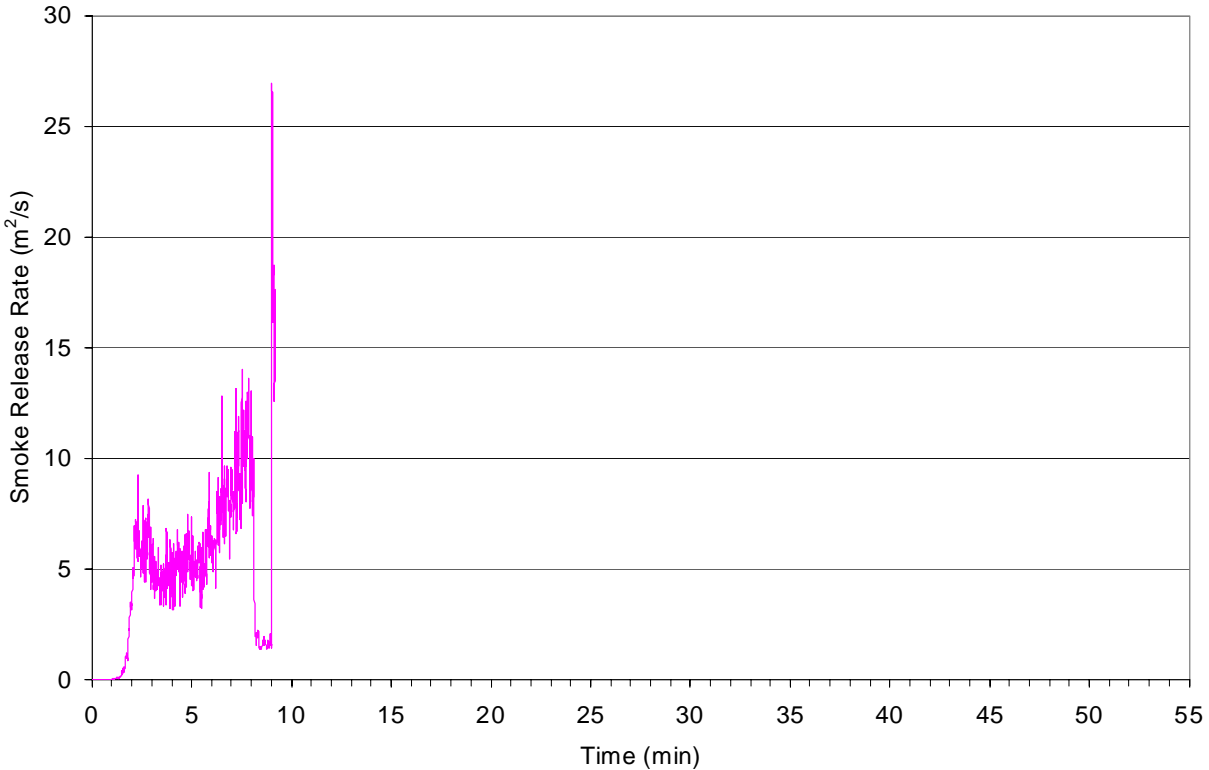
### Heat and Smoke Release Rates

Graphs of the heat and smoke release rates for the attic fire scenario are shown in Figure 4-47 and Figure 4-48 respectively. Heat release rate does not exceed 200 kW for the first 2 minutes of the fire. Within the next minute it increased to 700 kW and then gradually increased to 850 kW over the next 5 minutes (8 minutes after ignition). The fire then rapidly attained HRR value of approximately 1.8 MW. Smoke production correspondingly followed the heat production with limited smoke production for the first 2 minutes after which thick black smoke was observed venting out of the attic window (5 to 8 m<sup>2</sup>/s). Once the attic trap door was opened, smoke release rate reached as high as 26 m<sup>2</sup>/s before suppression was started.



**Figure 4-47: Heat release rate during the fire growth phase of the attic fire.**

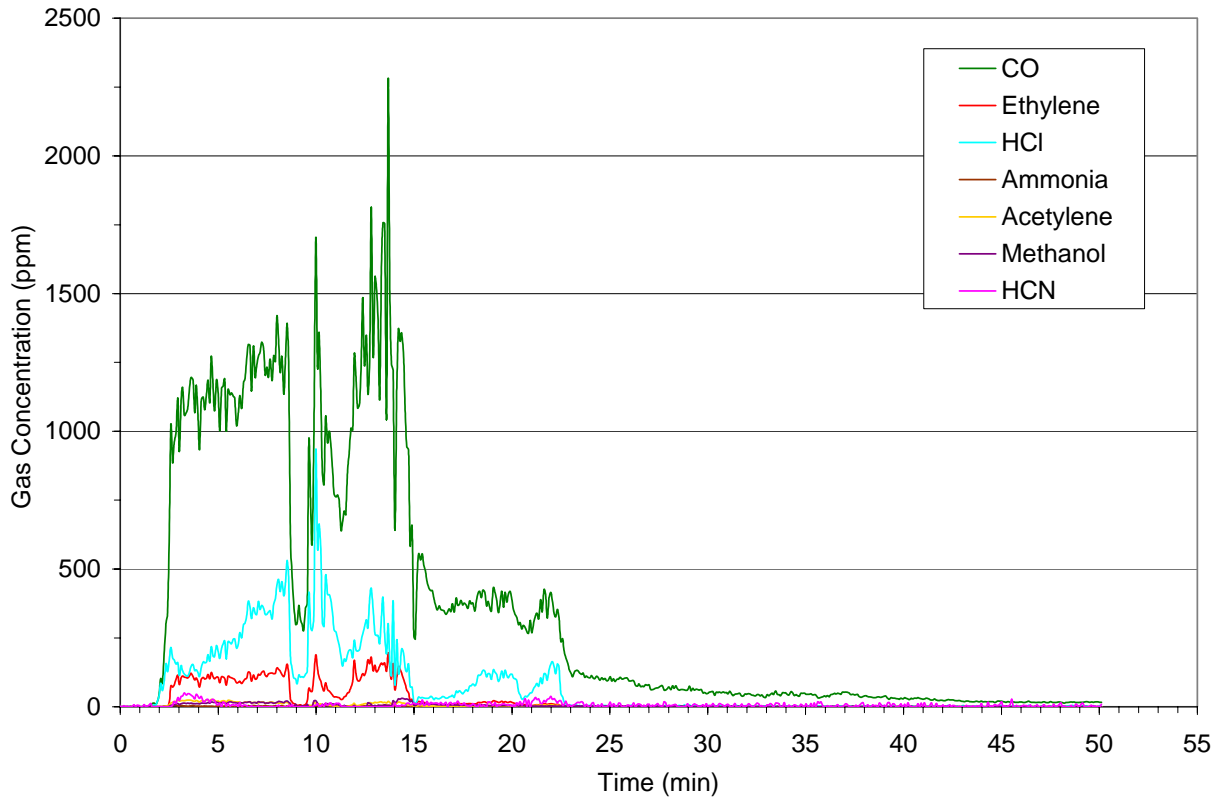




**Figure 4-48: Smoke release rate during the fire growth phase of the attic fire.**

### **Effluent Gas Composition – OP-FTIR**

Concentrations of gases in the smoke plumes escaping the attic window and roof trap door during the course of the attic fire test were measured by OP-FTIR for the duration of the fire test. Results for gases other than water and carbon dioxide are plotted in Figure 4-49. Note the rapid rise in gas concentrations corresponding to the same time frames as the rise in heat and smoke release rates. Prior to opening the roof trap door, carbon monoxide concentrations reached as high as 1,400 ppm and hydrogen chloride gas exceeded 500 ppm. Active suppression into the opened trap door reduced gas concentrations by a factor of 5 but between suppression bursts concentrations rebounded reaching greater than 2,200 ppm for carbon monoxide and greater than 900 ppm for hydrogen chloride gas. At the end of suppression (15 minutes after ignition) the carbon monoxide concentration was approximately 400 ppm, hydrogen chloride gas was 130 ppm, and hydrogen cyanide gas was as great as 30 ppm.



**Figure 4-49: Gas concentration measured by OP-FTIR for the attic fire.**

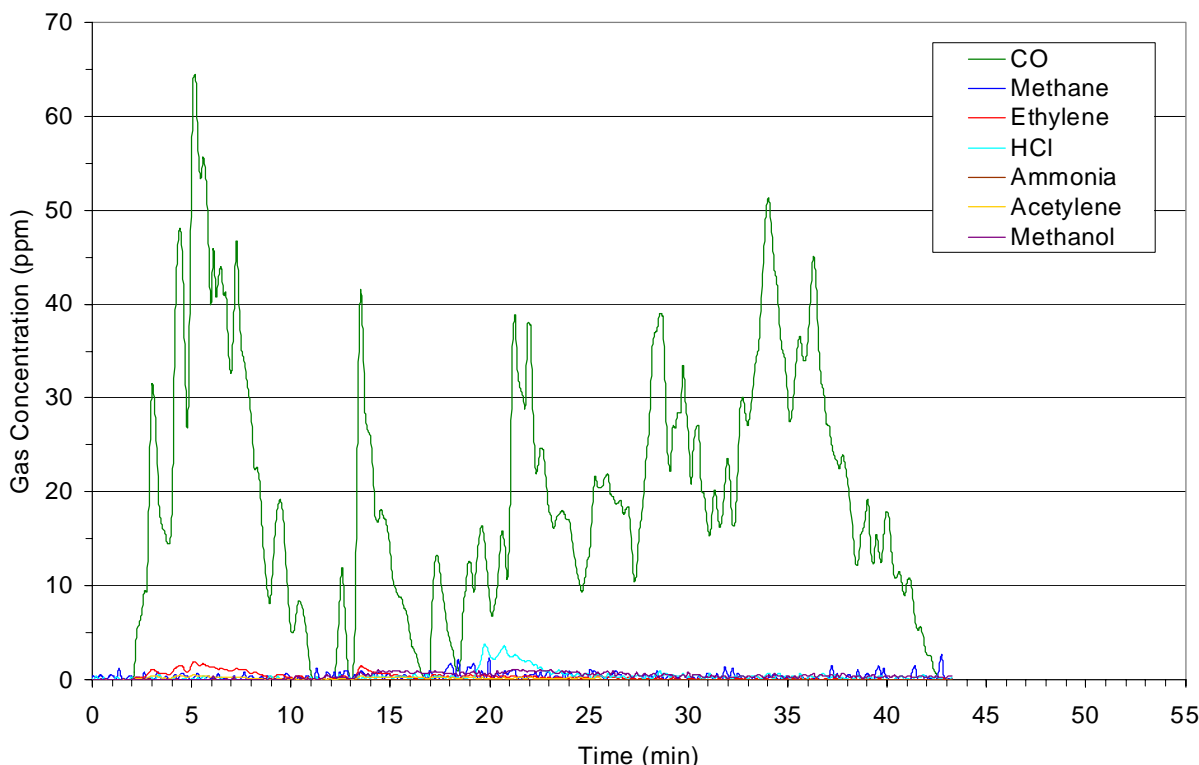
Peak gas concentrations and calculated total exposures are summarized in Table 4-22.

**Table 4-22: Summary of OP-FTIR gas concentration data for the attic fire.**

| Gas       | Peak concentration (ppm) | Total exposure (ppm-min) |
|-----------|--------------------------|--------------------------|
| CO        | 2276.8                   | 17,708.3                 |
| Ethylene  | 196.9                    | 1288.0                   |
| HCl       | 933.0                    | 3876.8                   |
| Ammonia   | 5.7                      | 35.6                     |
| Acetylene | 26.7                     | 197.7                    |
| Methanol  | 31.0                     | 206.6                    |
| HCN       | 50.1                     | 328.6                    |

**Effluent Gas Composition – Extractive FTIR**

Concentrations of gases present in the room below the attic space were measured by extractive FTIR. Results for gases other than water and carbon dioxide are plotted in Figure 4-50. Gas concentrations throughout the test, fire growth, suppression, and overhaul were below 70 ppm for carbon monoxide and 5 ppm for the other detected gases.



**Figure 4-50: Gas concentration measured by extractive FTIR for the attic fire.**

Peak gas concentrations and calculated total exposures are summarized in Table 4-23.

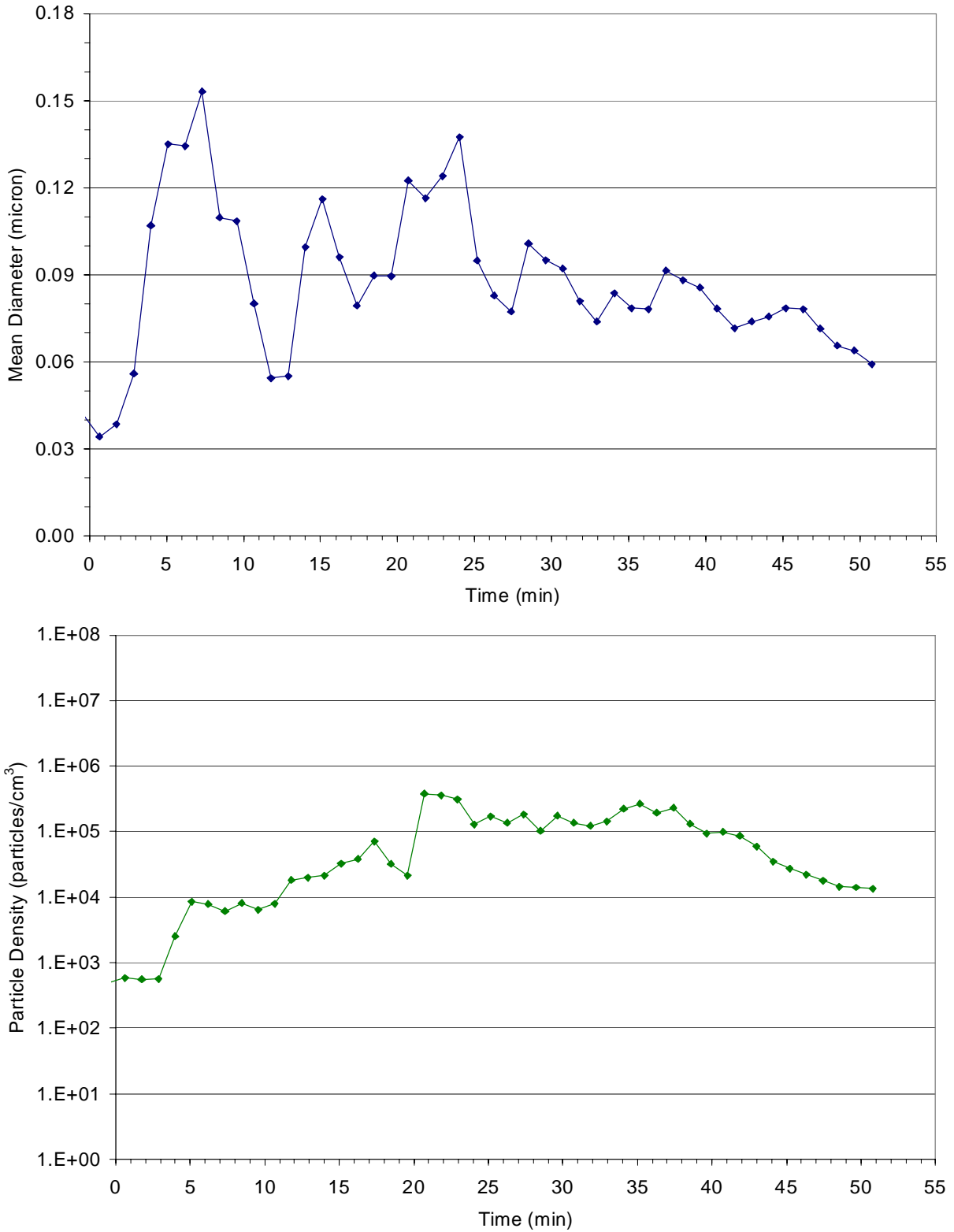
**Table 4-23: Summary of extractive FTIR gas concentration data for the attic fire.**

| Gas       | Fire Growth (until suppression) |                          | Overhaul                 |                          |
|-----------|---------------------------------|--------------------------|--------------------------|--------------------------|
|           | Peak concentration (ppm)        | Total exposure (ppm-min) | Peak concentration (ppm) | Total exposure (ppm-min) |
| CO        | 64.4                            | 216.7                    | 51.3                     | 580.2                    |
| Methane   | 1.2                             | 2.4                      | 2.6                      | 12.7                     |
| Ethylene  | 1.9                             | 6.9                      | 1.5                      | 6.9                      |
| HCl       | 0.6                             | 0.8                      | 3.8                      | 17.6                     |
| Ammonia   | 1.0                             | 0.0                      | 0.0                      | 1.7                      |
| Acetylene | 0.6                             | 1.9                      | 0.4                      | 5.7                      |
| Methanol  | 0.4                             | 0.4                      | 1.2                      | 19.4                     |

### Smoke Particle Analyzer

The average smoke particle size and particle count density in the room below the attic space, as characterized with the WPS spectrometer, is depicted in Figure 4-51. The average smoke particle size varies from 0.03 micron (essentially “normal clean” air) at the beginning of the test fire to as large as 0.15 microns during the more robust burning period. During overhaul the average smoke particle size ranged from 0.08 to 0.14 microns depending upon the activity being conducted. Toward the end of overhaul, the last 25 minutes, the average particle size remained fairly consistent at 0.077 ±0.009 microns. The particle count density however increased by almost three orders of magnitude during the course of the fire growth and suppression activity before

eventually falling 1½ orders for the end of overhaul. As seen in the plot of the particle size distribution, Figure 4-52, particles measuring less than 0.5 microns were the most prevalent.



**Figure 4-51: Smoke particle average size (top) and count density (bottom) measured with the particle analyzer for the attic fire.**

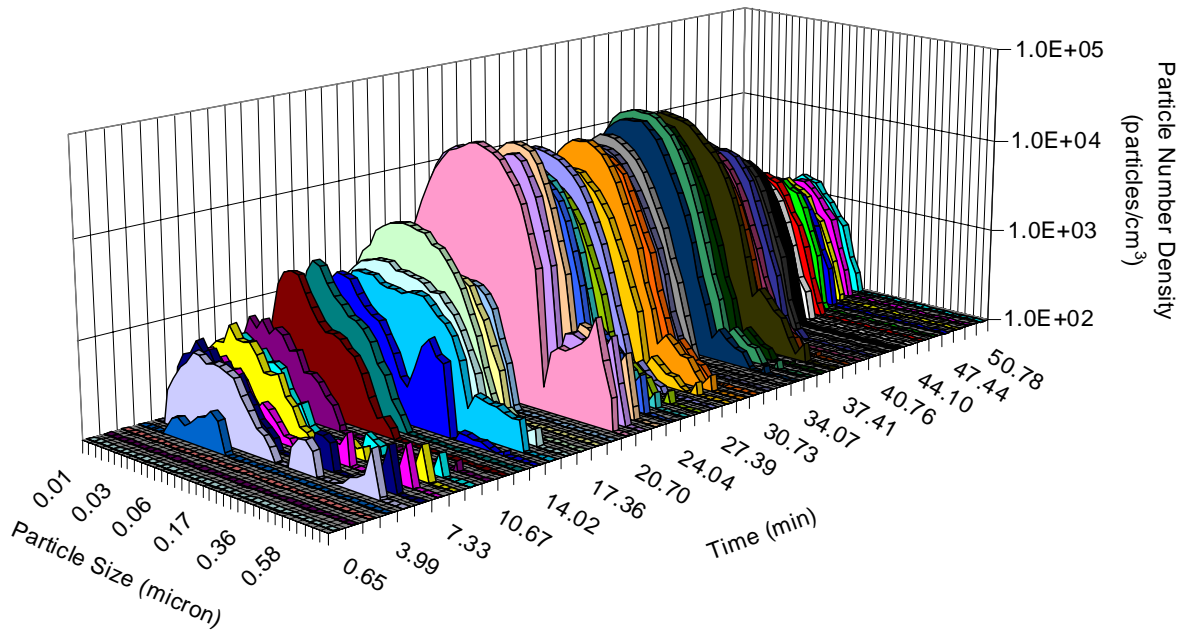


Figure 4-52: Smoke particle size distribution measured with the particle analyzer for the attic fire.

**Smoke Particle Size Distribution**

The size distribution of smoke particles in the attic space during the first 3:16 minutes of fire growth was determined using the high flow bench-top cascade impactor. Results summarized in Table 4-24 corroborate the prevalence of submicron-sized particles as measured with the WPS,

Table 4-24: Smoke particle size distribution measured with the bench-top cascade impactor during the initial fire growth phase of the attic fire.

| Stage No. | Cut Plate (micron) | Particulate Weight (µg) | Fraction of Collected Mass |
|-----------|--------------------|-------------------------|----------------------------|
| 1         | 10                 | <100                    | negligible                 |
| 2         | 2.5                | <100                    | negligible                 |
| 3         | 1                  | 890                     | 3.47%                      |
| 4         | 0.25               | 4990                    | 19.43%                     |
| 5         | Glass fiber filter | 19800                   | 77.10%                     |

**Personal Air Sampling – Gas**

Although two firefighters wore personal gas monitors and impactors during overhaul operations, one of the gas monitors was inadvertently shut-off. Measured gas concentrations for the remaining one firefighter are plotted in Figure 4-53. Spikes in the personal gas concentration correspond to when the firefighters were pulling down drywall and insulation (increases in room gas concentrations were also observed for this time period by extractive FTIR).

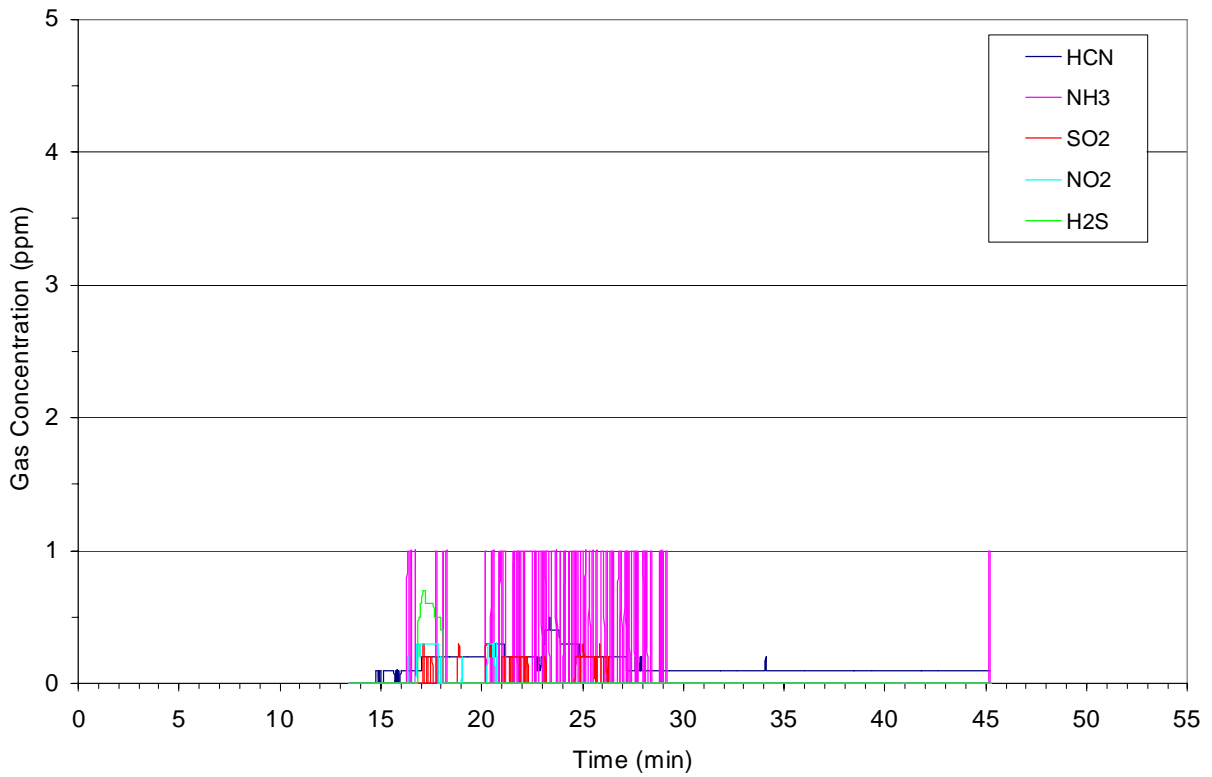
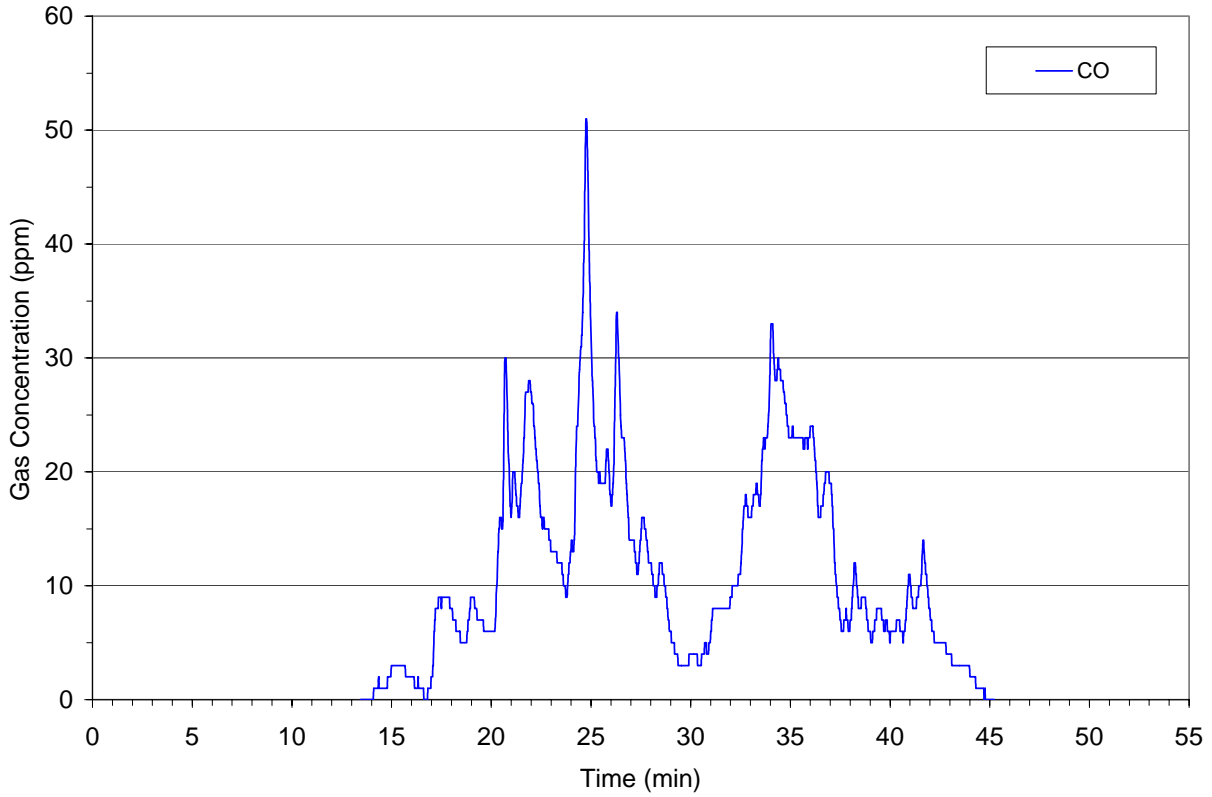


Figure 4-53: Gas concentrations measured by personal monitors during overhaul of the attic fire.

Peak gas concentrations and calculated total exposures for the firefighter with the operating monitor are summarized in Table 4-25.

**Table 4-25: Summary of personal gas monitor data for overhaul of the attic fire.**

| Gas              | Responder #1             |                          |
|------------------|--------------------------|--------------------------|
|                  | Peak concentration (ppm) | Total exposure (ppm-min) |
| HCN              | 0.5                      | 4.4                      |
| NH <sub>3</sub>  | 1.0                      | 4.0                      |
| SO <sub>2</sub>  | 0.3                      | 0.7                      |
| NO <sub>2</sub>  | 0.3                      | 0.5                      |
| H <sub>2</sub> S | 0.7                      | 0.7                      |
| CO               | 51.0                     | 361.7                    |

### Personal Air Sampling – Smoke Particle Size Distribution

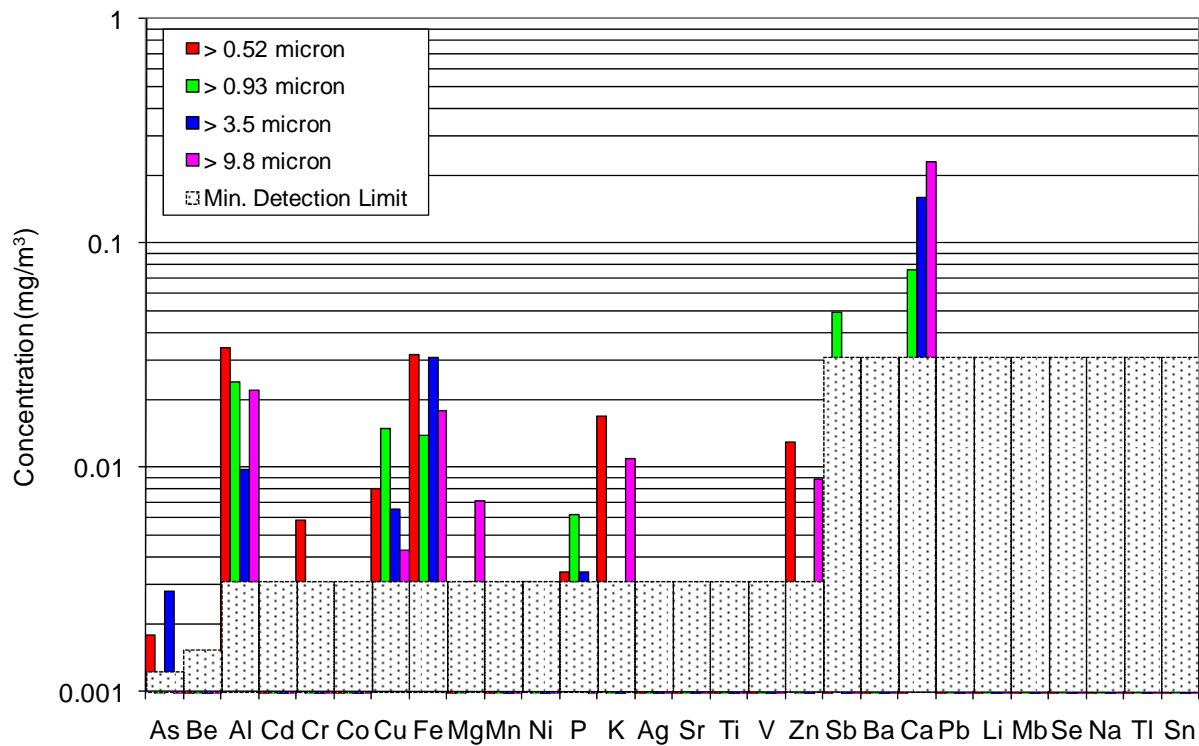
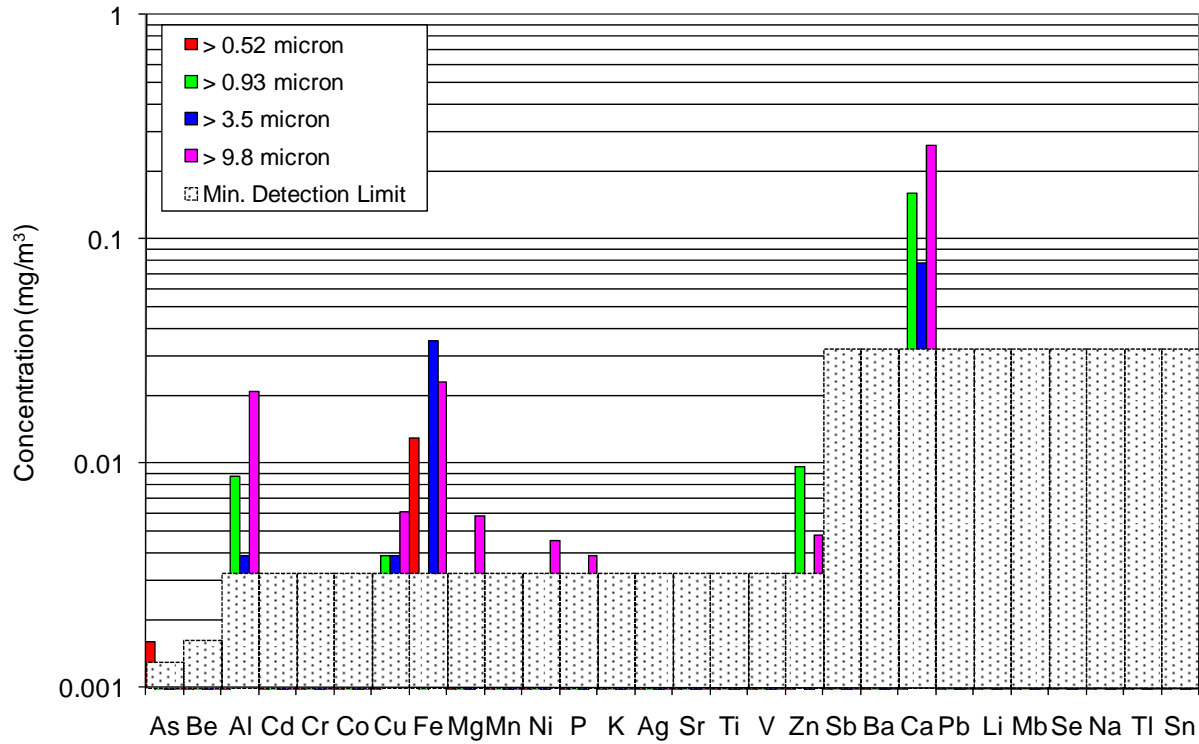
Analysis of the smoke particles accumulated on the four personal cascade impactor cut plates (0.52, 0.93, 3.5, 9.8 micron) worn by the two firefighters, Table 4-26, reveals that the relative mass distributions are similar for the two firefighters and the largest particle sizes, greater than 9.8 microns, were prevalent in both cases.

**Table 4-26: Mass distribution of smoke particles collected on personal cascade impactors during overhaul of the attic fire.**

| Particle Size | % Mass Fraction |                |
|---------------|-----------------|----------------|
|               | Firefighter #1  | Firefighter #2 |
| > 0.52 micron | 6.5             | 5.9            |
| > 0.93 micron | 30.4            | 22.4           |
| > 3.5 micron  | 16.4            | 13.9           |
| > 9.8 micron  | 46.7            | 57.8           |

### Personal Air Sampling – Smoke Particle Inorganic Content

Inorganic elemental analysis of the smoke particulates collected with the personal impactor worn by the firefighters are plotted in Figure 4-54. Calcium was found to be most prevalent followed by aluminum, copper, and iron. Antimony, chromium, phosphor, potassium, and zinc were found to a lesser degree. Arsenic was also found in particles collected for both firefighters.



**Figure 4-54: Inorganic element concentrations measured for smoke particles collected with personal cascade impactors during overhaul of the attic fire.**



### Effluent Gas Composition – Area Stands

Average airborne benzene, styrene, formaldehyde, and mercury concentrations in the room below the attic space were determined using the using the collection tubes on area sampling stands. One stand was positioned to sample below the open attic access panel in the front right corner of the room throughout the fire test and the other stand was positioned to sample below the other open attic access panel during the 30 minute overhaul operation period. Results for the two stands are summarized in Table 4-27.

**Table 4-27: Gas concentrations collected with area sampling stand during the attic fire.**

| Species      | Detection Limit (µg) | Sampling Stand: total test |                           | Sampling Stand: overhaul |                          |
|--------------|----------------------|----------------------------|---------------------------|--------------------------|--------------------------|
|              |                      | Mass (µg)                  | Concentration             | Mass (µg)                | Concentration            |
| Benzene      | 1.1                  | 2.8                        | 0.092 ppm                 | 2.4                      | 0.12 ppm                 |
| Styrene      | 1.2                  | 1.4                        | 0.034 ppm                 | < 1.2                    | < 0.045 ppm              |
| Formaldehyde | 0.1                  | 2.9                        | 0.19 ppm                  | 1.9                      | 0.2 ppm                  |
| Mercury      | 0.0025               | 0.0025                     | 0.00025 mg/m <sup>3</sup> | 0.0089                   | 0.0014 mg/m <sup>3</sup> |

### 4.3.6 Wood Deck

The hot coals that “spilled” on the deck ignited the top surface of the deck boards and the coals that “spilled” off the deck ignited the excelsior. In less than 1 minute the burning excelsior spread to engage the plastic sleds and the underside of the deck boards. Flames passing through the gaps between deck boards engaged the plastic deck chairs then spread to the other deck furnishings. Within 12 minutes of ignition the soffit melted and fell to the deck allowing smoke to infiltrate into the attic space. Suppression commenced 12:36 minutes after ignition and the fire was then teased for 4 minutes prior to full suppression and subsequent 30 minutes of overhaul activities.

#### Heat and Smoke Release Rates

Graphs of the heat and smoke release rates for the attic fire scenario are shown in Figure 4-55 and Figure 4-56 respectively. After the initial 3 minutes, during which the heat release rate reached 540 kW, the HRR remained consistent at approximately 145 kW for 5 minutes. During the next 2 minutes the fire spread to the seat cushions and the HRR increased by 100 kW to approximately 245 kW. In the next 1½ minutes (10 minutes after ignition), the fire spread to the table top, umbrella and fully engaged the other chairs; the resulting HRR was in excess of 7 MW prior to commencing suppression. Smoke production correspondingly followed the heat production and reached a smoke release rate in excess of 17 m<sup>2</sup>/s before suppression commenced.

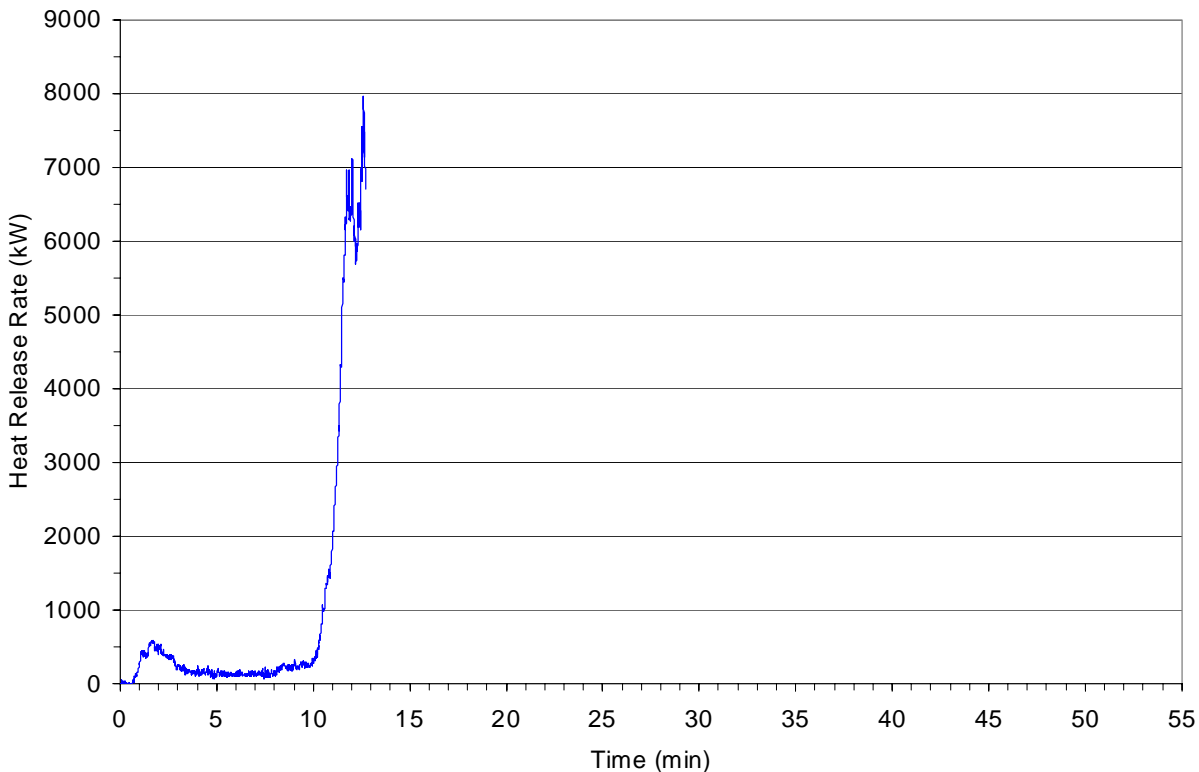
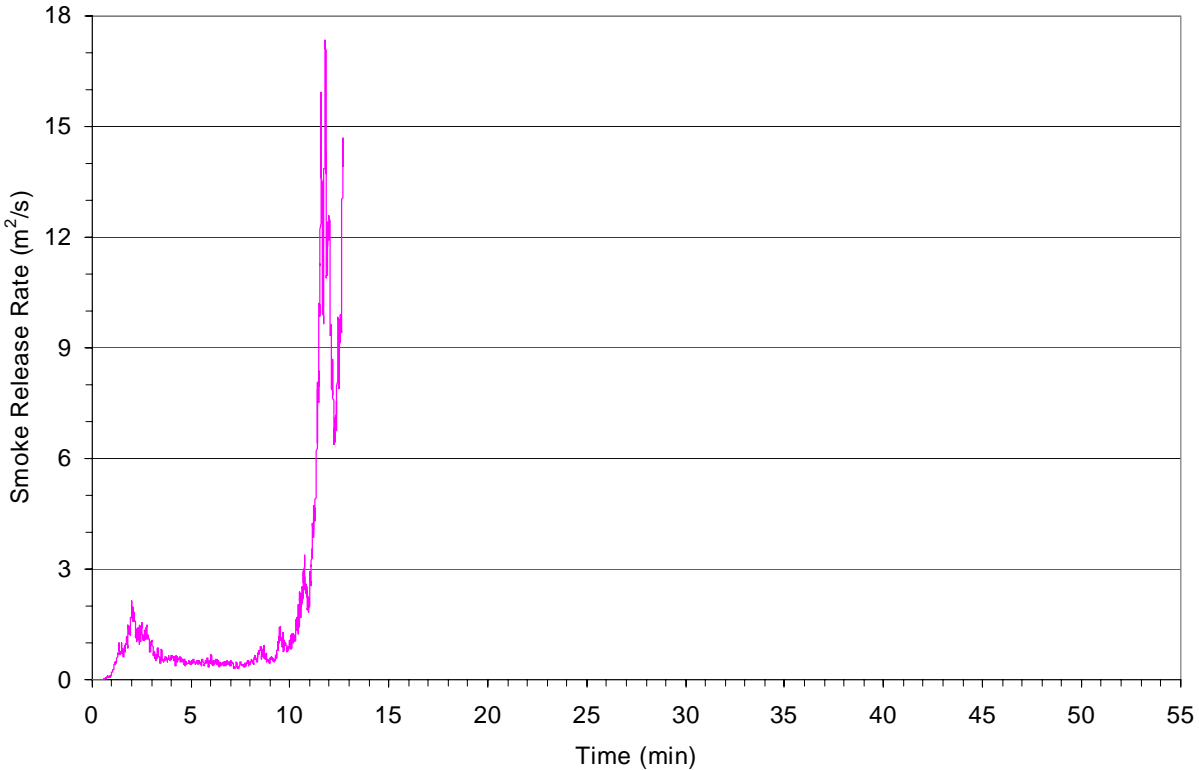


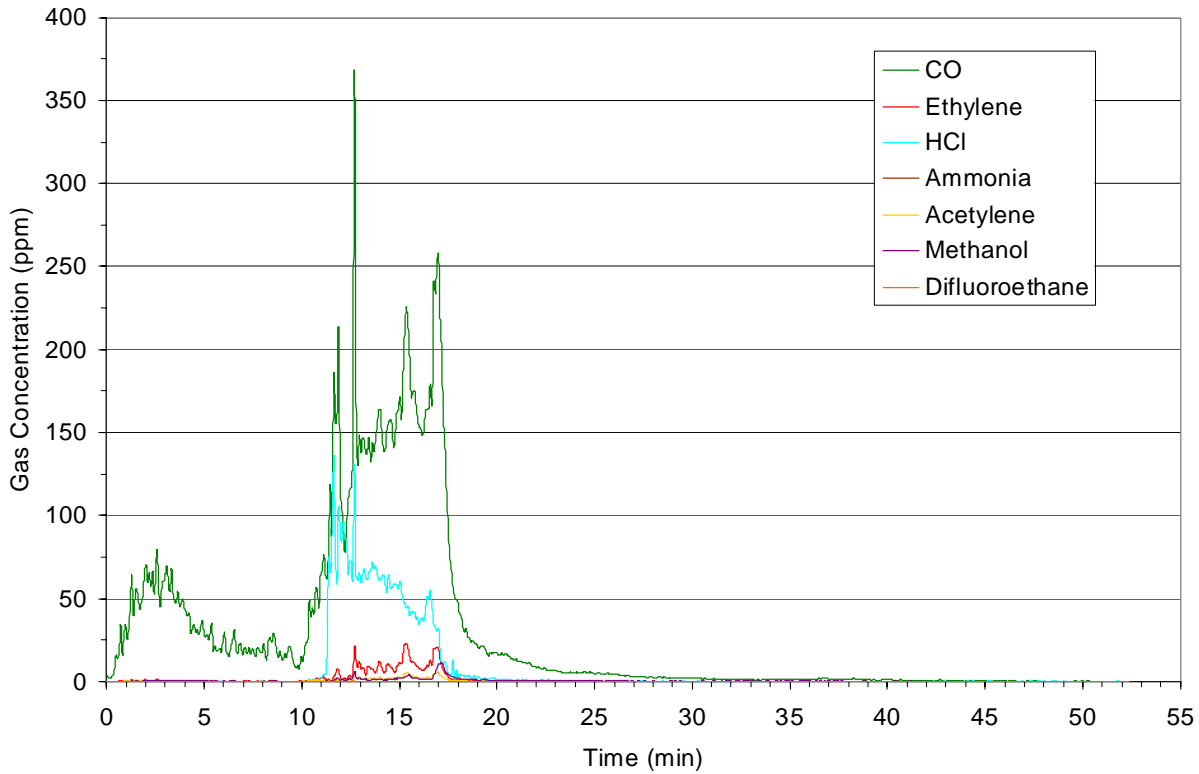
Figure 4-55: Heat release rate during the fire growth phase of the wood deck fire.



**Figure 4-56: Smoke release rate during the fire growth phase of the wood deck fire.**

### **Effluent Gas Composition – OP-FTIR**

Concentrations of gases in the smoke plume above the wood deck structure were measured by OP-FTIR for the duration of the fire test. Results for gases other than water and carbon dioxide are plotted in Figure 4-57. Note the changes in gas concentrations corresponding to the same time frames as the rise in heat and smoke release rates. Prior to the soffit melting and falling, the gas of notable concentration was carbon monoxide, which ranged from 10 to 80 ppm. Once the soffit was engaged in the fire and the fire “teasing” commenced, the carbon monoxide concentration increased to between 140 and 260 ppm; concentrations of other gases such as hydrogen chloride gas however became significant at 38 to 135 ppm. Within 2 minutes of commencing full suppression, there was a 5 fold reduction in gas concentrations. After 5 minutes of overhaul gas concentrations were reduced below 5 ppm.



**Figure 4-57: Gas concentration measured by OP-FTIR for the wood deck fire.**

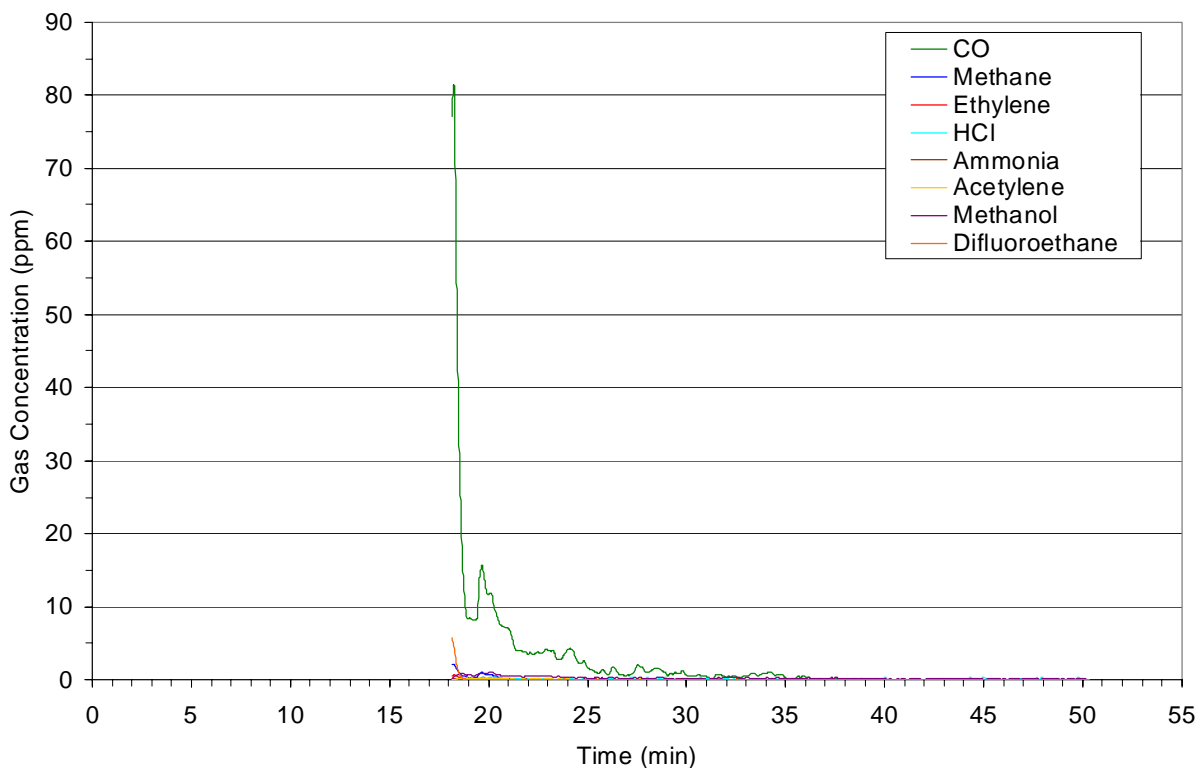
Peak gas concentrations and calculated total exposures are summarized in Table 4-28.

**Table 4-28: Summary of OP-FTIR gas concentration data for the wood deck fire.**

| Gas            | Peak concentration (ppm) | Total exposure (ppm-min) |
|----------------|--------------------------|--------------------------|
| CO             | 368.5                    | 1512.7                   |
| Ethylene       | 23.3                     | 66.8                     |
| HCl            | 135.9                    | 369.9                    |
| Ammonia        | 0.6                      | 1.0                      |
| Acetylene      | 5.7                      | 19.3                     |
| Methanol       | 11.7                     | 33.2                     |
| Difluoroethane | 0.4                      | 0.2                      |

**Effluent Gas Composition – Extractive FTIR**

Concentrations of gases above the deck structure at the side of the “house” were measured by extractive FTIR. Results for gases other than water and carbon dioxide are plotted in Figure 4-58. Gas concentrations immediately following full suppression, 18 minutes after ignition, were 80 ppm for carbon monoxide and 5 ppm for the other detected gases. Within 1 minute gas concentrations fell by a factor of 5. These concentrations are roughly half that as observed for the same time period using the OP-FTIR which was positioned at approximately double the elevation.



**Figure 4-58: Gas concentration measured by extractive FTIR during overhaul of the wood deck fire.**

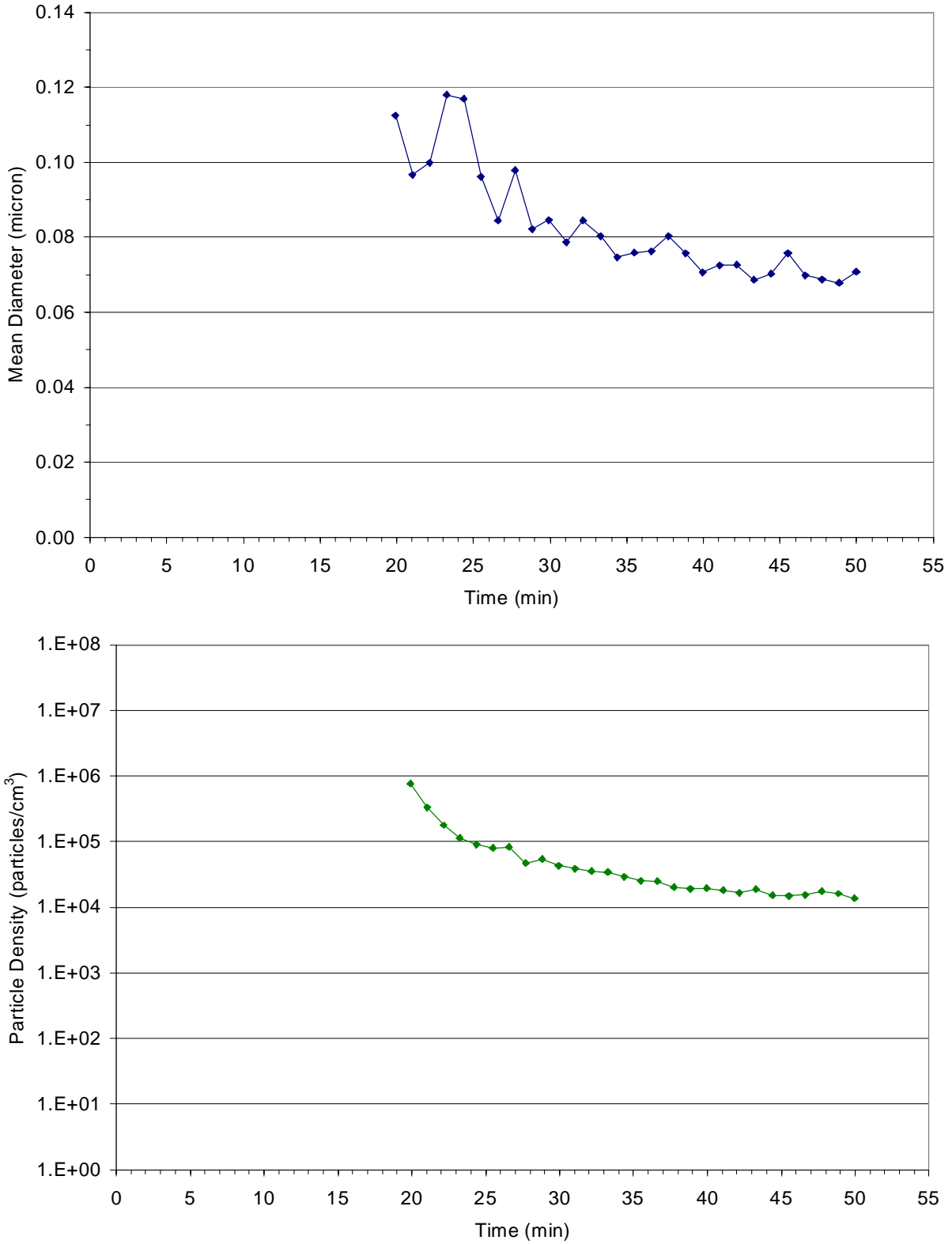
Peak gas concentrations and calculated total exposures are summarized in Table 4-29.

**Table 4-29: Summary of extractive FTIR gas concentration data for overhaul of the wood deck fire.**

| Gas            | Peak concentration (ppm) | Total exposure (ppm-min) |
|----------------|--------------------------|--------------------------|
| CO             | 81.0                     | 76.3                     |
| Methane        | 2.1                      | 2.0                      |
| Ethylene       | 0.7                      | 1.6                      |
| HCl            | 0.4                      | 3.0                      |
| Ammonia        | 0.3                      | 0.7                      |
| Acetylene      | 0.2                      | 2.0                      |
| Methanol       | 1.1                      | 8.7                      |
| Difluoroethane | 5.8                      | 1.4                      |

### Smoke Particle Analyzer

The average smoke particle size and particle count density above the wood deck structure at the side of the “house”, as characterized with the WPS spectrometer, is depicted in Figure 4-59. The average smoke particle size steadily decreased from 0.11 microns to 0.07 microns throughout the 30 minute overhaul period. The particle count density correspondingly decreased by 1½ order reduction during the same time period to stabilize around 15,500 ±1,300 particles per cubic centimeter. As seen in the plot of the particle size distribution, Figure 4-60, prevalence of particles measuring less than 0.36 microns increased with overhaul time.



**Figure 4-59: Smoke particle average size (top) and count density (bottom) measured with the particle analyzer during overhaul of the wood deck fire.**

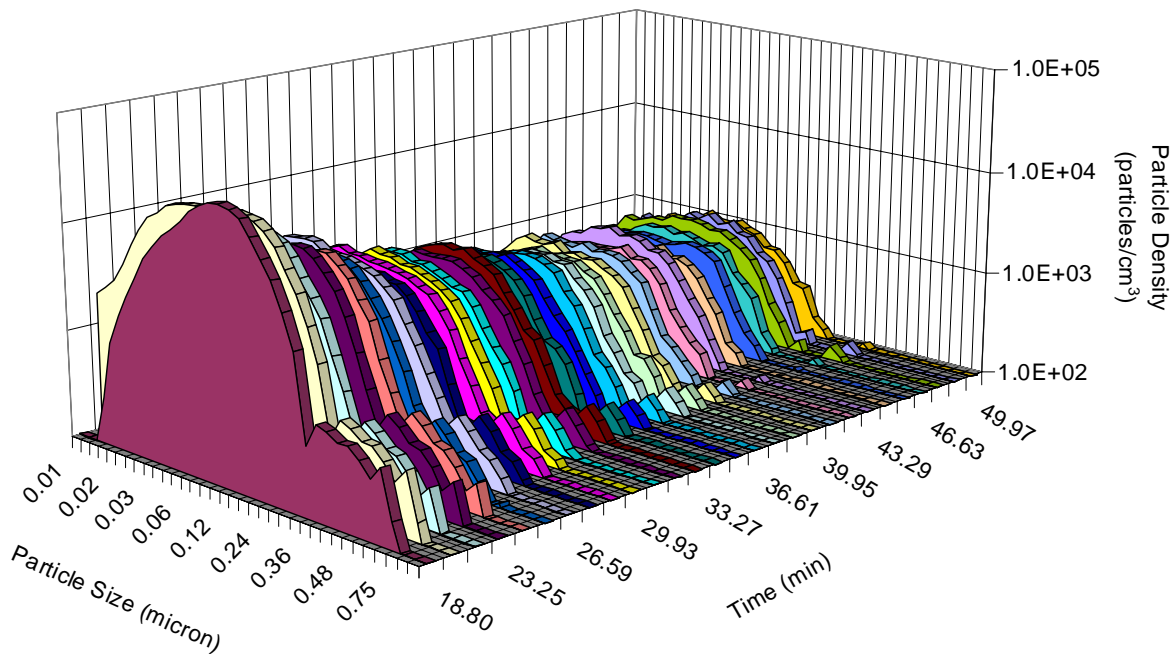


Figure 4-60: Smoke particle size distribution measured with the particle analyzer during overhaul of the wood deck fire.

**Smoke Particle Size Distribution**

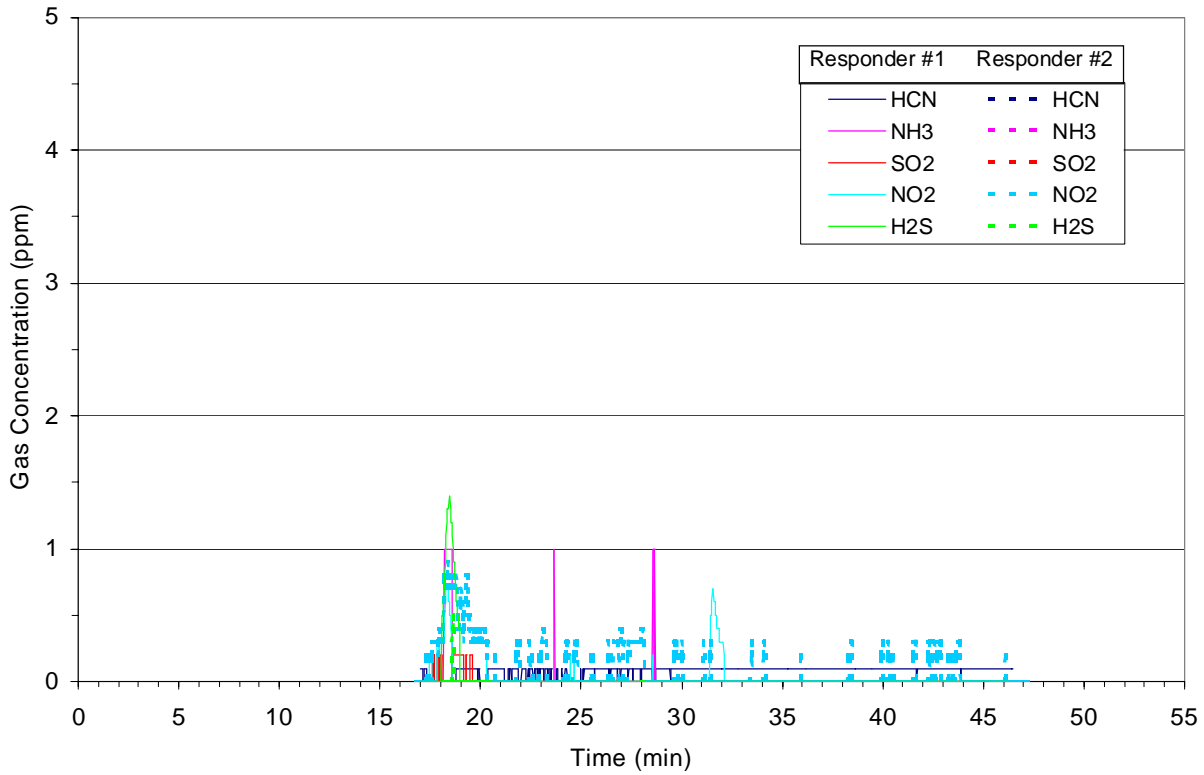
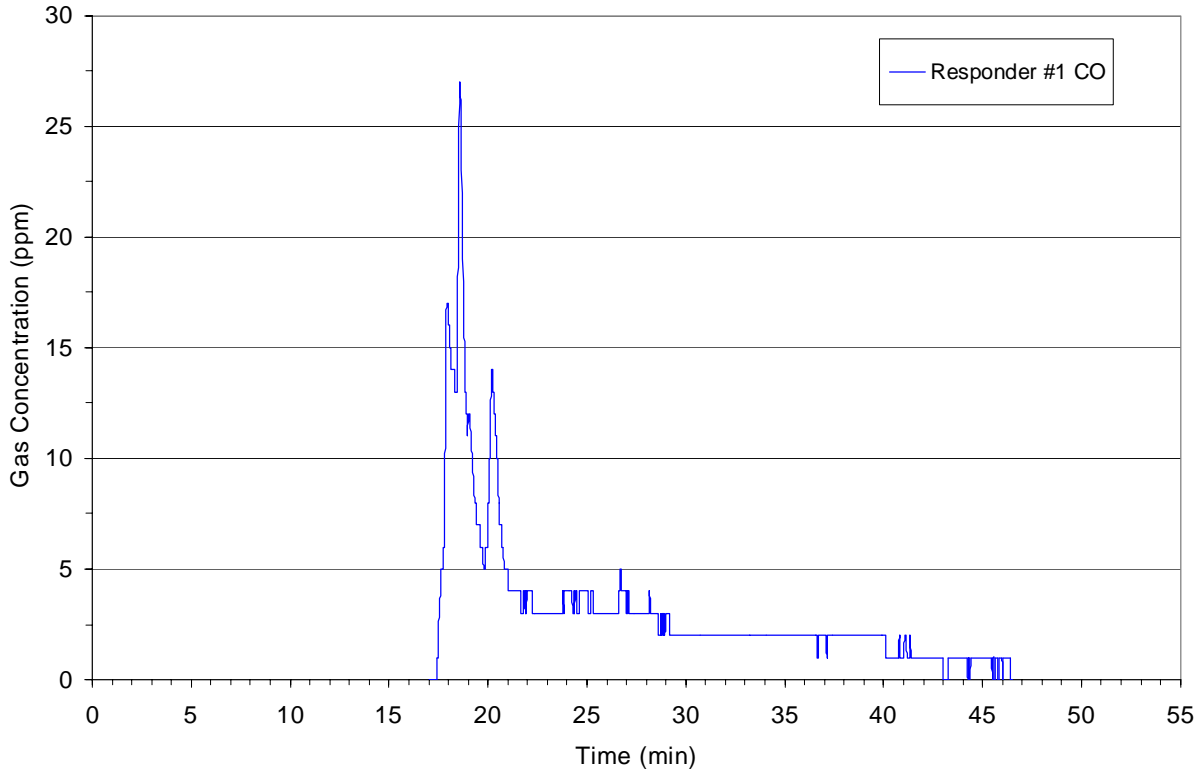
The size distribution of smoke particles above the sliding glass door during the fire growth phase was determined using the high flow bench-top cascade impactor. Results summarized in Table 4-30 corroborate the prevalence of submicron-sized particles as measured with the WPS,

Table 4-30: Smoke particle size distribution measured with the bench-top cascade impactor during the fire growth phase of the wood deck fire.

| Stage No. | Cut Plate (micron) | Particulate Weight (µg) | Fraction of Collected Mass |
|-----------|--------------------|-------------------------|----------------------------|
| 1         | 10                 | <100                    | negligible                 |
| 2         | 2.5                | <100                    | negligible                 |
| 3         | 1                  | <100                    | negligible                 |
| 4         | 0.25               | <100                    | negligible                 |
| 5         | Glass fiber filter | 21610                   | 100.00%                    |

**Personal Air Sampling – Gas**

Two firefighters wore personal gas monitors and impactors during overhaul operations. The carbon monoxide sensor in the gas monitor worn by Responder #2 failed to operate. Measured gas concentrations are plotted in Figure 4-61. Measured gas concentrations were considerably lower for overhaul of this “outdoor” fire than those observed for the contained room fires.



**Figure 4-61: Gas concentrations measured by personal monitors during overhaul of the wood deck fire.**



Peak gas concentrations and calculated total exposures for the two firefighters are summarized in Table 4-31.

**Table 4-31: Summary of personal gas monitor data for overhaul of the wood deck fire.**

| Gas              | Responder #1             |                          | Responder #2             |                          |
|------------------|--------------------------|--------------------------|--------------------------|--------------------------|
|                  | Peak concentration (ppm) | Total exposure (ppm-min) | Peak concentration (ppm) | Total exposure (ppm-min) |
| HCN              | 0.1                      | 2.5                      | 0.0                      | 0.0                      |
| NH <sub>3</sub>  | 1                        | 0.5                      | 0.0                      | 0.0                      |
| SO <sub>2</sub>  | 0.2                      | 0.2                      | 0.0                      | 0.0                      |
| NO <sub>2</sub>  | 0.7                      | 0.7                      | 0.9                      | 2.5                      |
| H <sub>2</sub> S | 1.4                      | 0.8                      | 0.5                      | 0.0                      |
| CO               | 27                       | 92.3                     | failed                   | failed                   |

**Personal Air Sampling – Smoke Particle Size Distribution**

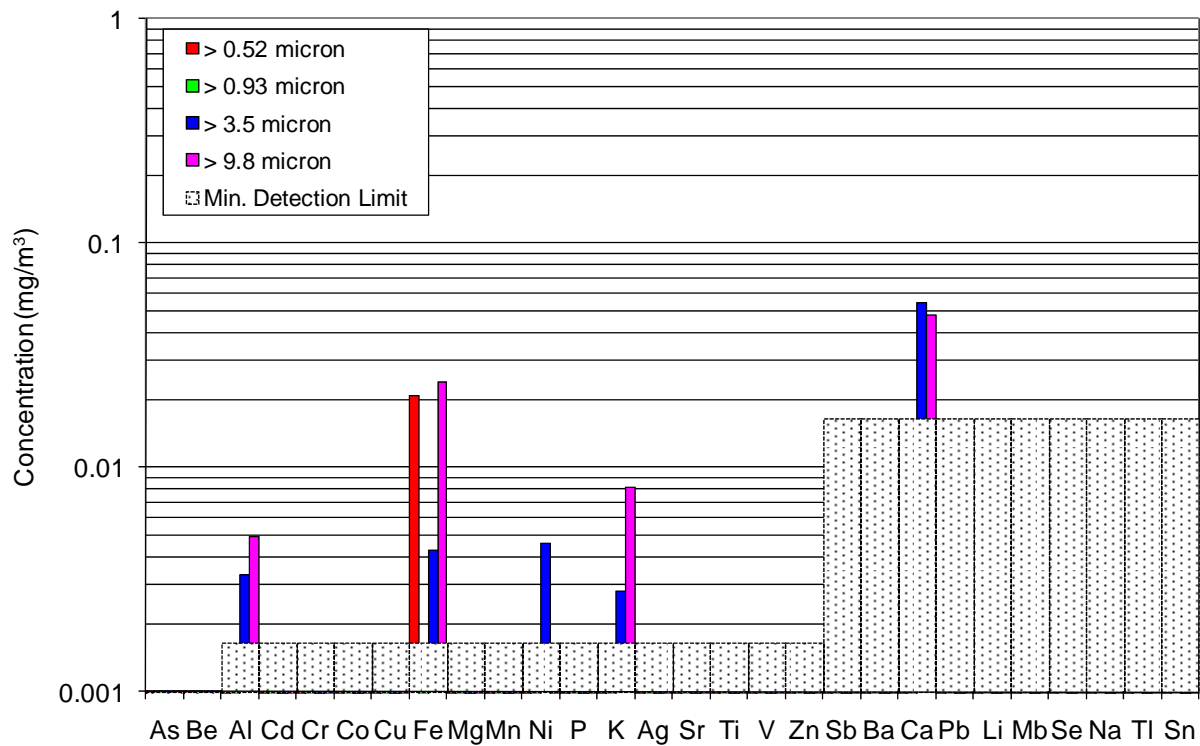
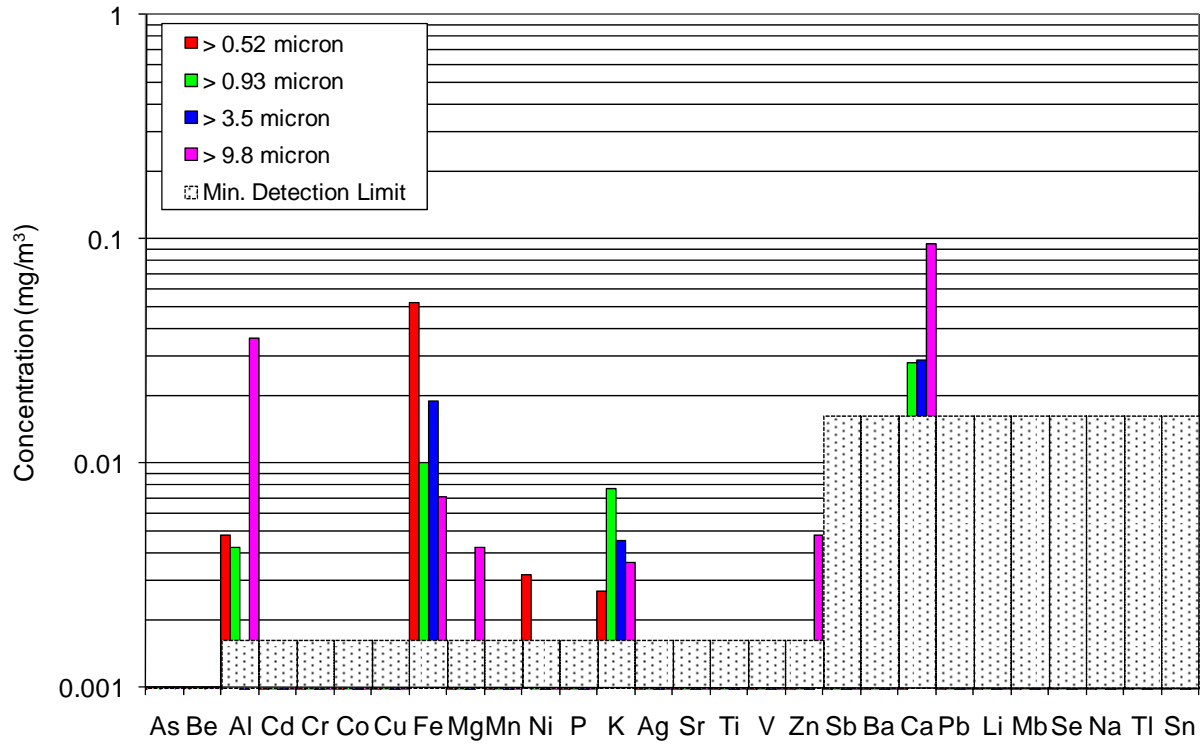
Analysis of the smoke particles accumulated on the four personal cascade impactor cut plates (0.52, 0.93, 3.5, 9.8 micron) worn by the two firefighters, Table 4-32, reveals that the relative mass distributions for the two firefighters are quite different, presumably due to the individual activities being performed. Despite these differences the largest particle sizes, greater than 9.8 microns, were prevalent for both firefighters.

**Table 4-32: Mass distribution of smoke particles collected on personal cascade impactors during overhaul of the wood deck fire.**

| Particle Size | % Mass Fraction |                |
|---------------|-----------------|----------------|
|               | Firefighter #1  | Firefighter #2 |
| > 0.52 micron | 7.0             | 6.9            |
| > 0.93 micron | 7.0             | 13.8           |
| > 3.5 micron  | 7.0             | 31.3           |
| > 9.8 micron  | 78.9            | 48.0           |

**Personal Air Sampling – Smoke Particle Inorganic Content**

Inorganic elemental analysis of the smoke particulates collected with the personal impactor worn by the firefighters are plotted in Figure 4-62. Calcium was found to be most prevalent followed by aluminum, iron, and potassium. Magnesium, nickel, and zinc were found to a lesser degree.



**Figure 4-62: Inorganic element concentrations measured for smoke particles collected with personal cascade impactors during overhaul of the wood deck fire.**

**Effluent Gas Composition – Area Stands**

Average airborne benzene, styrene, and formaldehyde concentrations in the deck vicinity were determined using the using the collection tubes on an area sampling stand. Results for the stand are summarized in Table 4-33.

**Table 4-33: Gas concentrations collected with area sampling stand for the wood deck fire.**

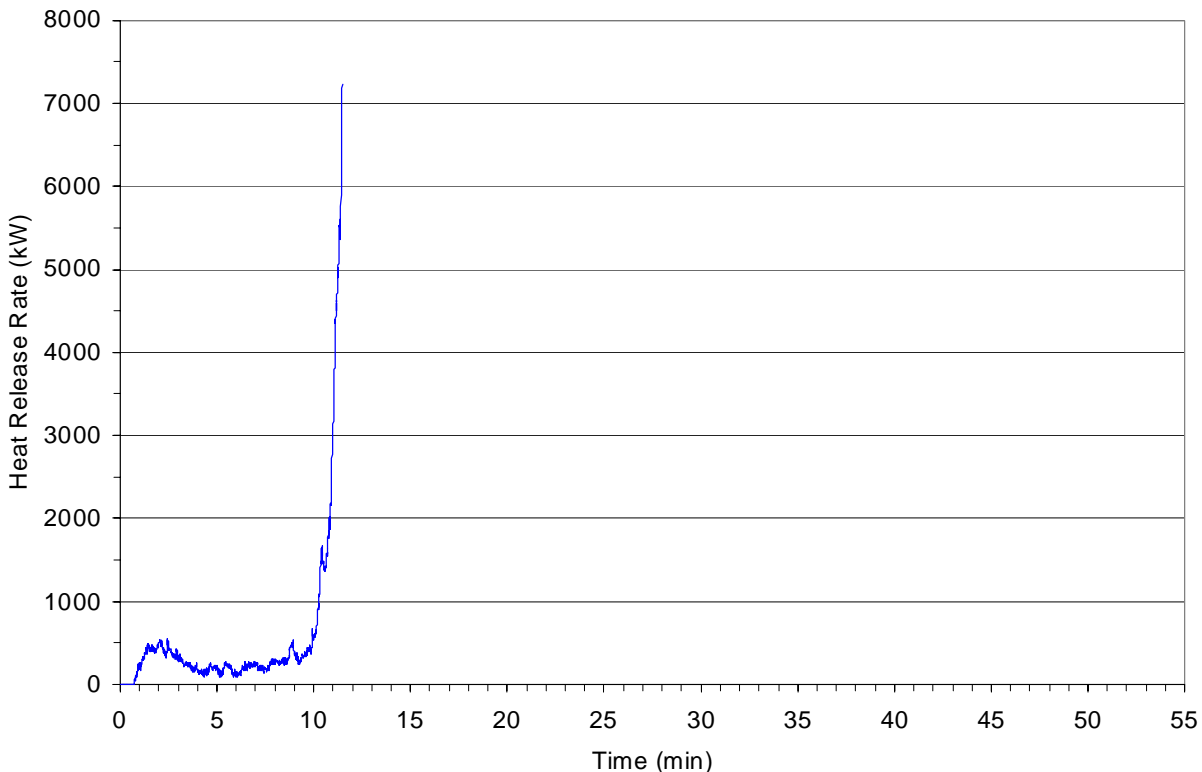
| Species      | Detection Limit (µg) | Sampling Stand |               |
|--------------|----------------------|----------------|---------------|
|              |                      | Mass (µg)      | Concentration |
| Benzene      | 1.1                  | < 1.0          | < 0.051 ppm   |
| Styrene      | 1.2                  | < 1.2          | < 0.046 ppm   |
| Formaldehyde | 0.1                  | 0.77           | 0.082 ppm     |

### 4.3.7 Composite Deck

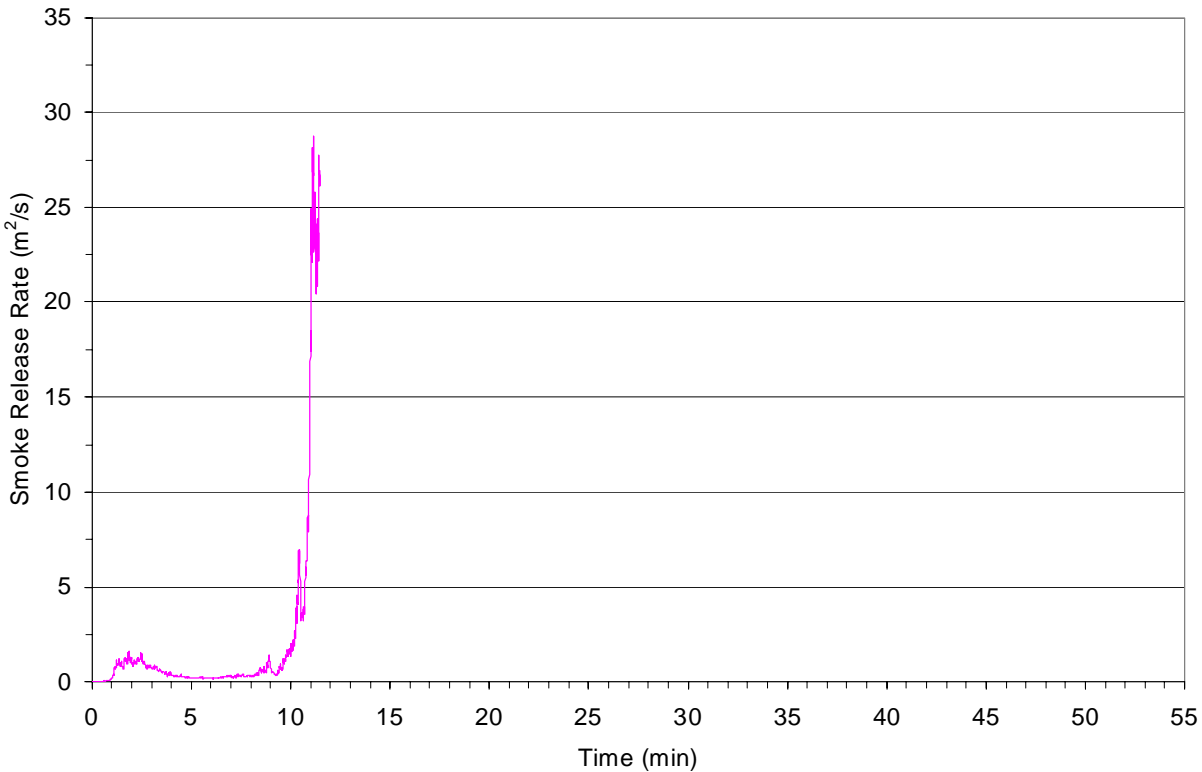
The hot coals that “spilled” on the deck ignited the top surface of the deck boards and the coals that “spilled” off the deck ignited the excelsior. In less than 1 minute the burning excelsior spread to engage the plastic sleds and the underside of the deck boards. Flames passing through the gaps between deck boards engaged the plastic deck chairs then spread to the other deck furnishings. Within 10½ minutes of ignition the soffit melted and fell to the deck allowing smoke to infiltrate into the attic space. Siding above the sliding glass door melted and fell to the deck within 30 seconds of the soffit. Suppression commenced 11:29 minutes after ignition (about 1 minute earlier than for the wood deck fire scenario) and the fire was then teased for 4 minutes prior to full suppression and subsequent 30 minutes of overhaul activities.

### Heat and Smoke Release Rates

Graphs of the heat and smoke release rates for the composite deck fire scenario are shown in Figure 4-63 and Figure 4-64 respectively. Heat release rate for the composite deck fire scenario was virtually the same as the wood deck fire scenario: HRR of 540 kW during the initial 3 minutes, consistent HRR of approximately 245 kW for next 5 minutes, 200 kW increase in HRR during the next 2 minutes as the seat cushions were engaged, and rapid increase in HRR to greater than 7 MW in less than 1½ minutes as the fire propagated to the table top, umbrella and siding. Smoke release rate was likewise similar except that as the siding was engaged in the fire the SRR exceeded 28 m<sup>2</sup>/s (versus 17 m<sup>2</sup>/s for the wood deck) prior to commencing suppression. This larger SRR can be attributed to the vinyl’s greater propensity to generate smoke than wood.



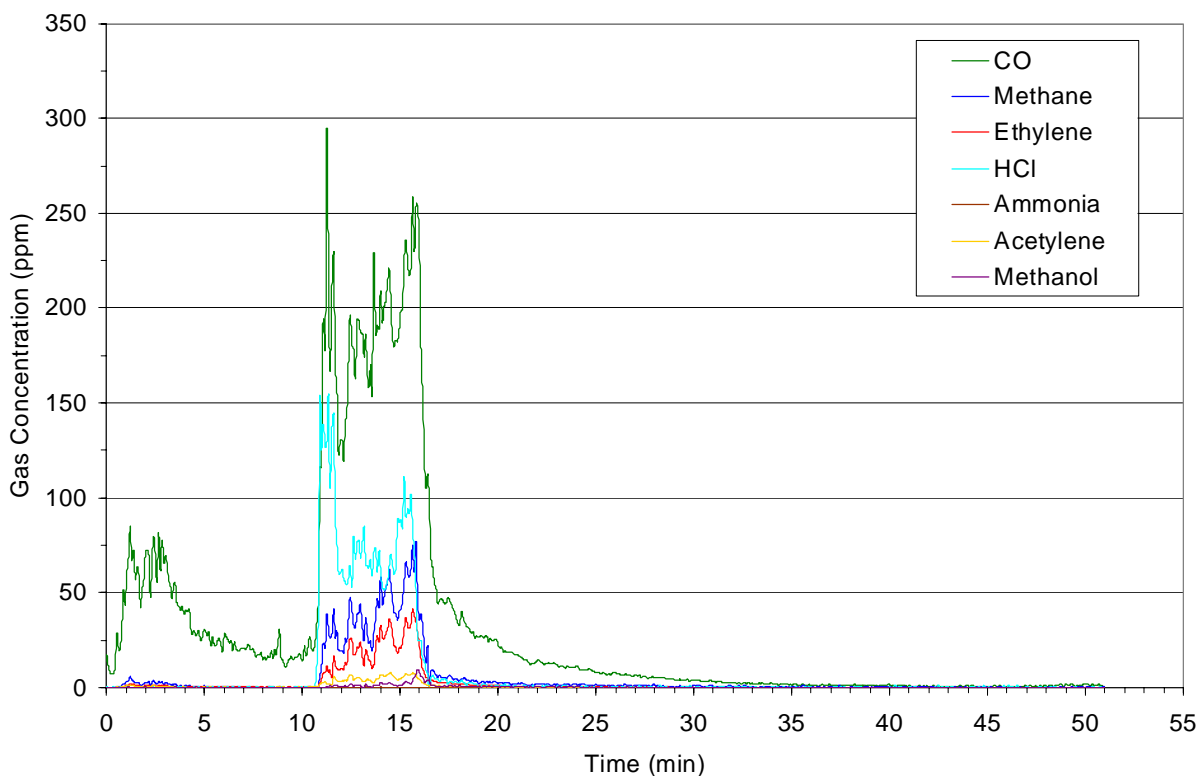
**Figure 4-63: Heat release rate during the fire growth phase of the composite deck fire.**



**Figure 4-64: Smoke release rate during the fire growth phase of the composite deck fire.**

### **Effluent Gas Composition – OP-FTIR**

Concentrations of gases in the smoke plume above the composite deck structure were measured by OP-FTIR for the duration of the fire test. Results for gases other than water and carbon dioxide are plotted in Figure 4-65. Gas concentrations were virtually the same as those measured for the wood deck structure. The only differences were during the “teasing” phase in which hydrogen chloride gas concentrations reached 150 ppm (versus 135 ppm for the wood deck) and the presence of methane which increased from approximately 40 to 80 ppm during the “teasing”. These increases are not surprising considering the greater amount of vinyl material engaged in the composite deck fire scenario. Once full suppression commenced, however, methane concentration decreased to comparable levels as the other gases. After 5 minutes of overhaul carbon monoxide concentration was reduced to 15 ppm and the other gases to less than 5 ppm.



**Figure 4-65: Gas concentration measured by OP-FTIR for the composite deck fire.**

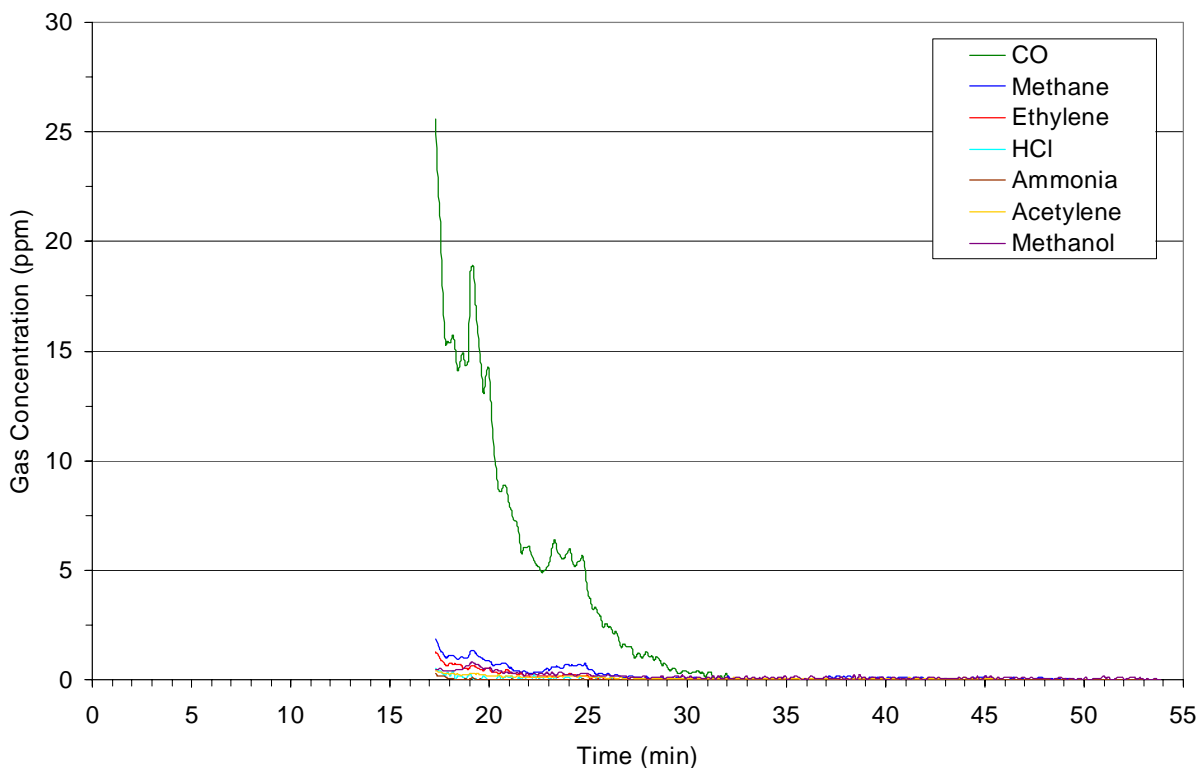
Peak gas concentrations and calculated total exposures are summarized in Table 4-34.

**Table 4-34: Summary of OP-FTIR gas concentration data for the composite deck fire.**

| Gas       | Peak concentration (ppm) | Total exposure (ppm-min) |
|-----------|--------------------------|--------------------------|
| CO        | 293.9                    | 1657.5                   |
| Methane   | 77.0                     | 258.3                    |
| Ethylene  | 41.4                     | 128.2                    |
| HCl       | 154.5                    | 437.3                    |
| Ammonia   | 0.5                      | 1.2                      |
| Acetylene | 7.8                      | 34.0                     |
| Methanol  | 9.6                      | 18.3                     |

**Effluent Gas Composition – Extractive FTIR**

Concentrations of gases above the deck structure at the side of the “house” were measured by extractive FTIR. Results for gases other than water and carbon dioxide are plotted in Figure 4-66. As with the OP-FTIR results, extractive FTIR measured gas concentrations exhibited similar results to those measured for the wood deck structure: comparable gas concentrations at the onset of overhaul and a 5-fold reduction in gas concentrations within 1 minute of overhaul. Also like the wood deck structure, extractive FTIR measured concentrations were roughly half that as observed for the same time period using the OP-FTIR (which was positioned at approximately double the elevation).



**Figure 4-66: Gas concentration measured by extractive FTIR during overhaul of the composite deck fire.** Peak gas concentrations and calculated total exposures are summarized in Table 4-35.

**Table 4-35: Summary of extractive FTIR gas concentration data for overhaul of the composite deck fire.**

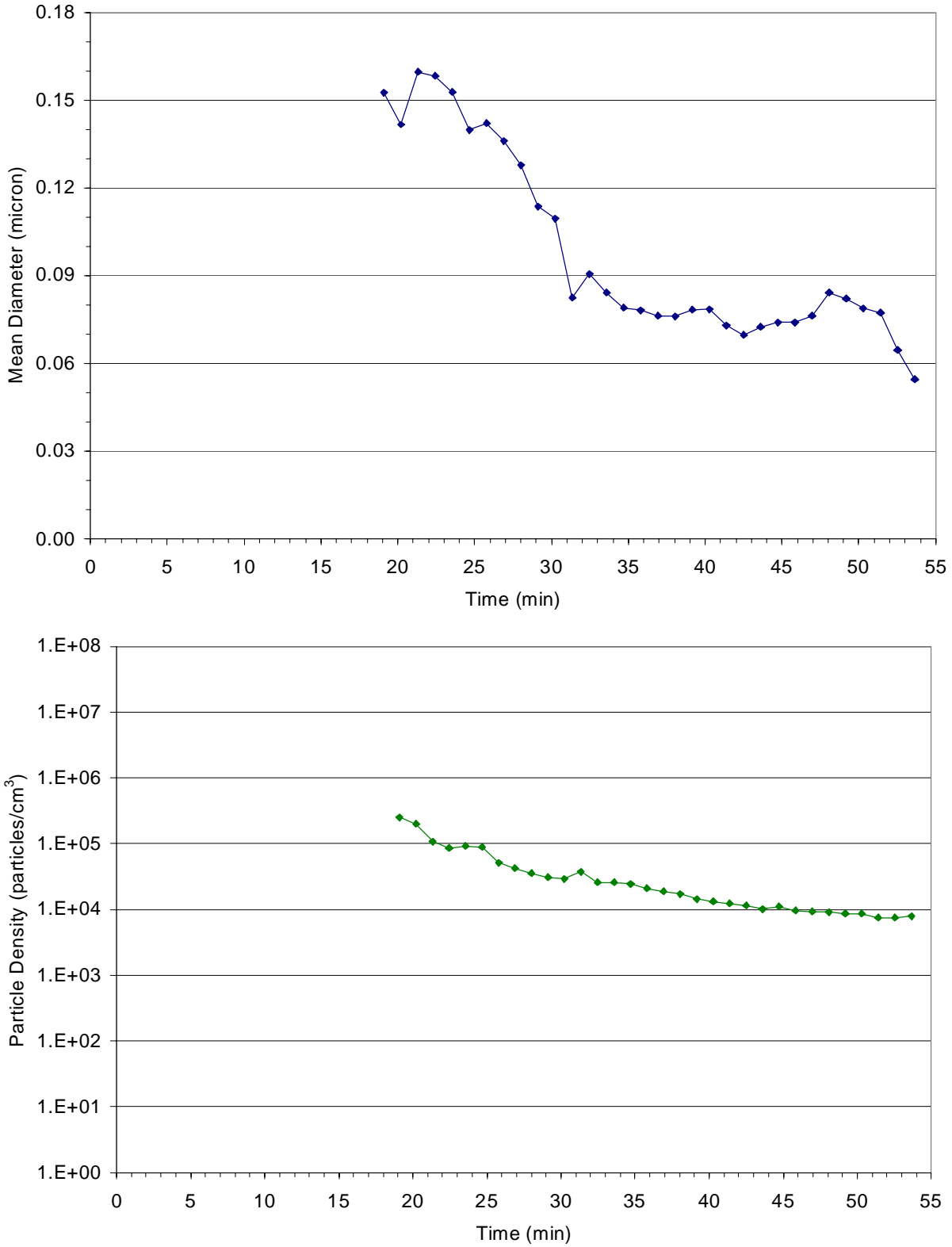
| Gas       | Peak concentration (ppm) | Total exposure (ppm-min) |
|-----------|--------------------------|--------------------------|
| CO        | 25.6                     | 85.2                     |
| Methane   | 1.9                      | 7.5                      |
| Ethylene  | 1.3                      | 3.2                      |
| HCl       | 0.6                      | 0.9                      |
| Ammonia   | 0.3                      | 0.2                      |
| Acetylene | 0.4                      | 3.4                      |
| Methanol  | 0.8                      | 5.6                      |

### Smoke Particle Analyzer

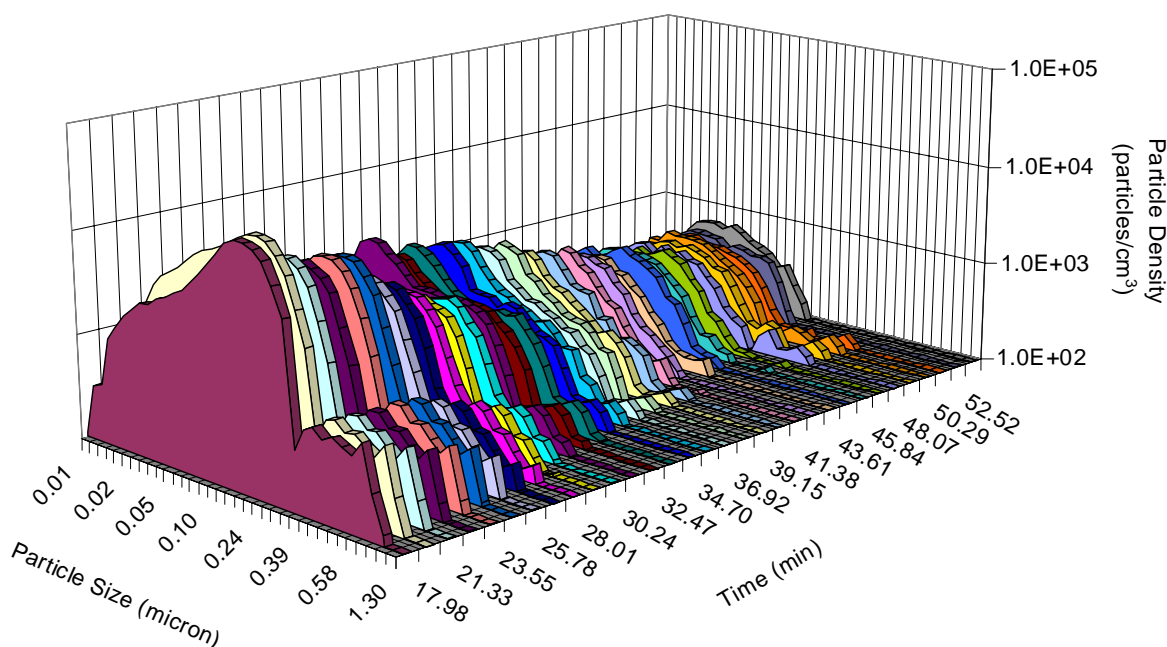
The average smoke particle size and particle count density above the composite deck structure at the side of the “house”, as characterized with the WPS spectrometer, Figure 4-67, also exhibits the same trends as observed for the wood deck structure: a steady reduction in average particle size and count density with overhaul time. At the onset of overhaul the average smoke particle size for the composite deck structure was larger than that of the wood deck structure, 0.16 microns versus 0.12 microns. This was most likely due to flaming vinyl generating a larger average smoke particle size than wood. Average smoke particle size after 30 minutes of overhaul for the composite deck structure however was comparable to that observed for the wood deck structure, 0.08 and 0.07 microns respectively. Average smoke particle sizes were found to return to pre-fire conditions, 0.05 microns, after 5 additional minutes of overhaul. Particle count density

likewise decreased by 1½ order reduction during the same time period to stabilize around 8,100 ±600 particles per cubic centimeter. Count densities for the composite deck structure were approximately 2/3 that of the wood deck structure; again this may be attributed to the effects of siding material chemistry differences on smoke production. As seen in the plot of the particle size distribution, Figure 4-68, prevalence of particles measuring less than 0.36 microns increased with overhaul time.





**Figure 4-67: Smoke particle average size (top) and count density (bottom) measured with the particle analyzer during overhaul of the composite deck fire.**



**Figure 4-68: Smoke particle size distribution measured with the particle analyzer during overhaul of the composite deck fire.**

### Smoke Particle Size Distribution

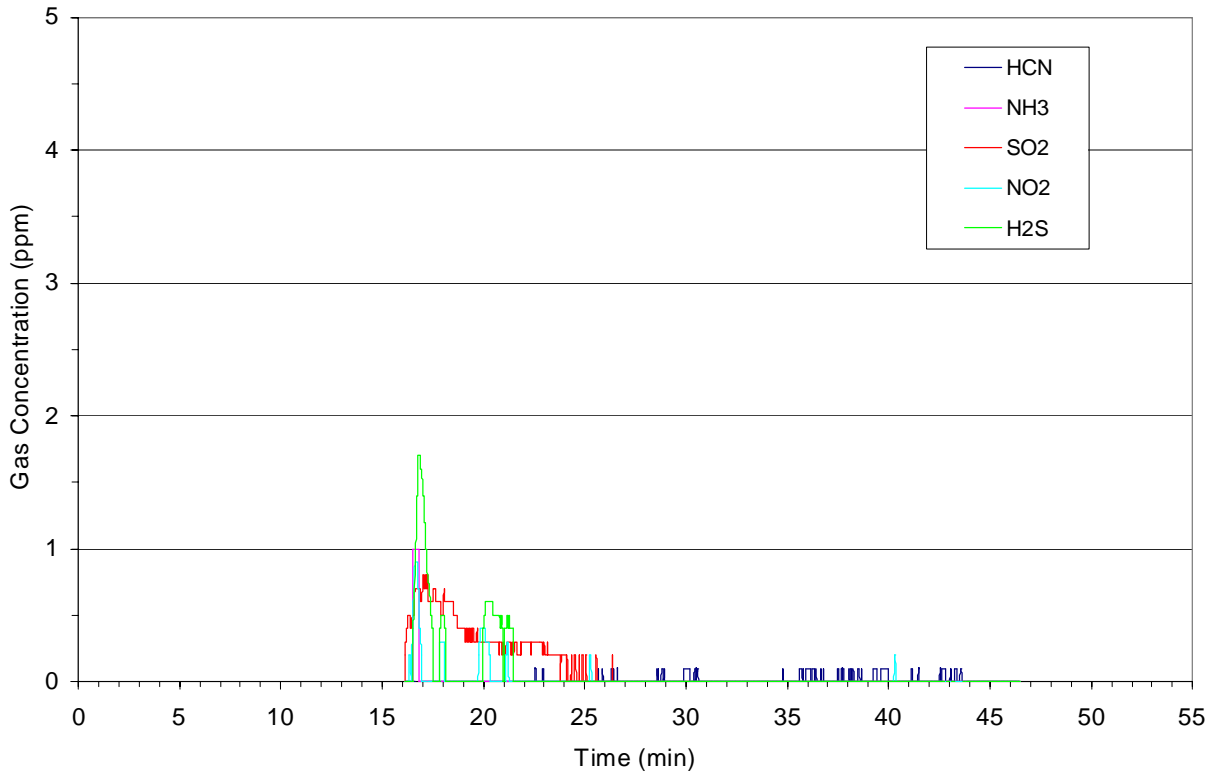
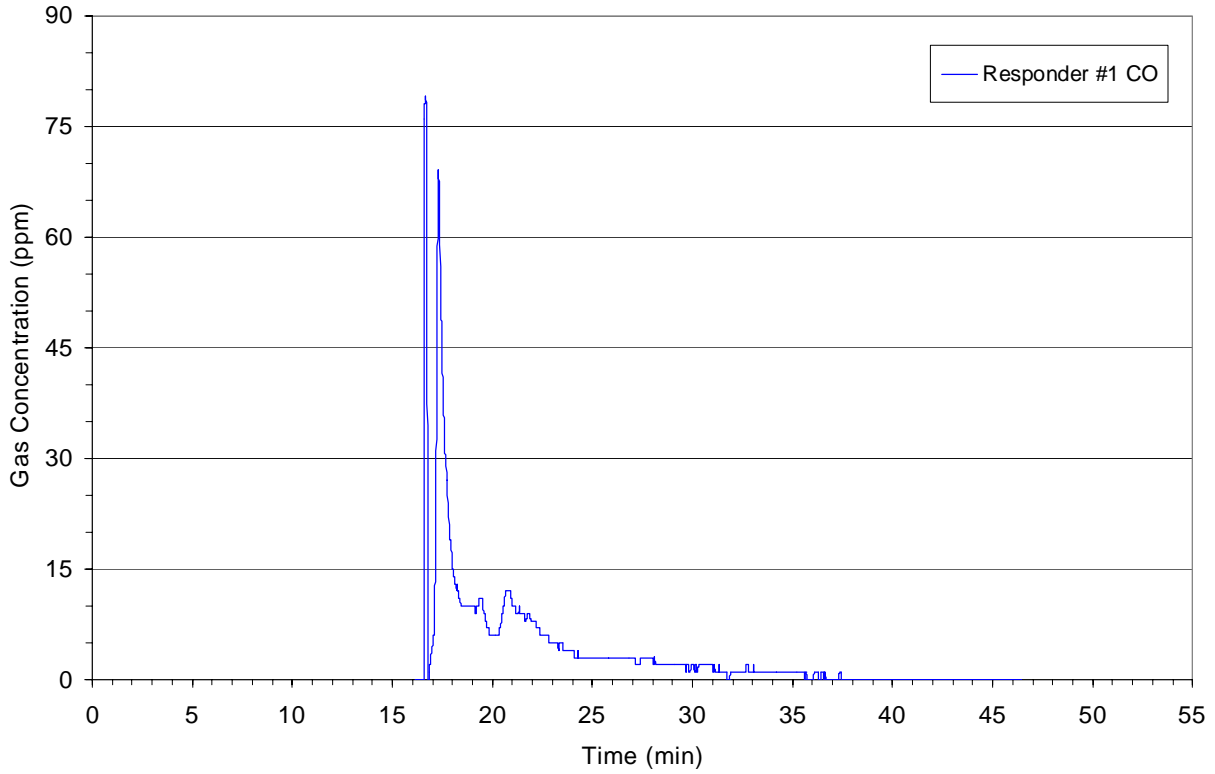
The size distribution of smoke particles above the sliding glass door during the fire growth phase was determined using the high flow bench-top cascade impactor. Results summarized in Table 4-36 corroborate the prevalence of submicron-sized particles as measured with the WPS and the greater average smoke particle size observed for the composite deck structure versus the wood deck structure.

**Table 4-36: Smoke particle size distribution measured with the bench-top cascade impactor during the fire growth phase of the composite deck fire.**

| Stage No. | Cut Plate (micron) | Particulate Weight (µg) | Fraction of Collected Mass |
|-----------|--------------------|-------------------------|----------------------------|
| 1         | 10                 | <100                    | negligible                 |
| 2         | 2.5                | <100                    | negligible                 |
| 3         | 1                  | <100                    | negligible                 |
| 4         | 0.25               | 930                     | 2.15%                      |
| 5         | Glass fiber filter | 42300                   | 97.85%                     |

### Personal Air Sampling – Gas

Although two firefighters wore personal gas monitors and impactors during overhaul operations, one of the gas monitors failed during use and no data was collected. Measured gas concentrations for the remaining one firefighter are plotted in Figure 4-69. With the exception of double the carbon monoxide levels for the composite deck structure fire, gas concentrations were comparable to those observed for the wood deck structure fire. Measured gas concentrations were considerably lower for overhaul of this “outdoor” fire than those observed for the contained room fires.



**Figure 4-69: Gas concentrations measured by personal monitors during overhaul of the composite deck fire.**

Peak gas concentrations and calculated total exposures for the firefighter with the operating monitor are summarized in Table 4-37.

**Table 4-37: Summary of personal gas monitor data for overhaul of the composite deck fire.**

| Gas              | Responder #1             |                          |
|------------------|--------------------------|--------------------------|
|                  | Peak concentration (ppm) | Total exposure (ppm-min) |
| HCN              | 0.1                      | 0.3                      |
| NH <sub>3</sub>  | 1.0                      | 0.3                      |
| SO <sub>2</sub>  | 0.8                      | 3.1                      |
| NO <sub>2</sub>  | 0.9                      | 0.7                      |
| H <sub>2</sub> S | 1.7                      | 1.9                      |
| CO               | 79.0                     | 118.7                    |

### Personal Air Sampling – Smoke Particle Size Distribution

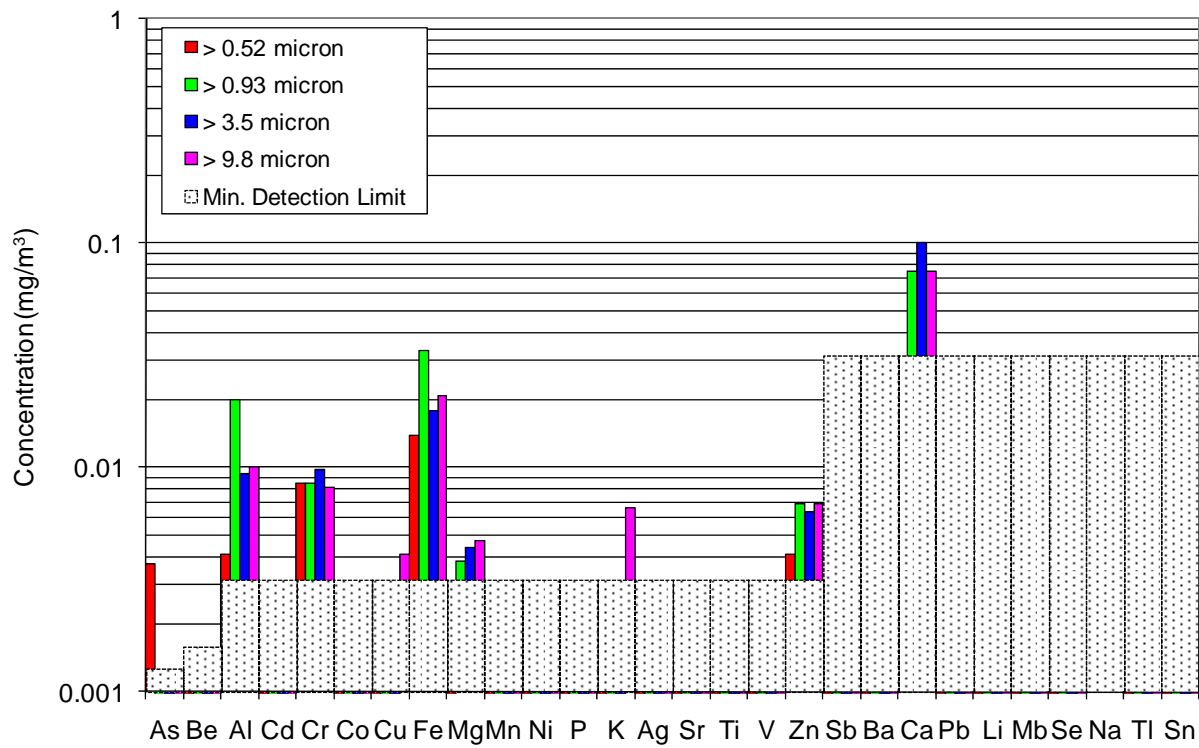
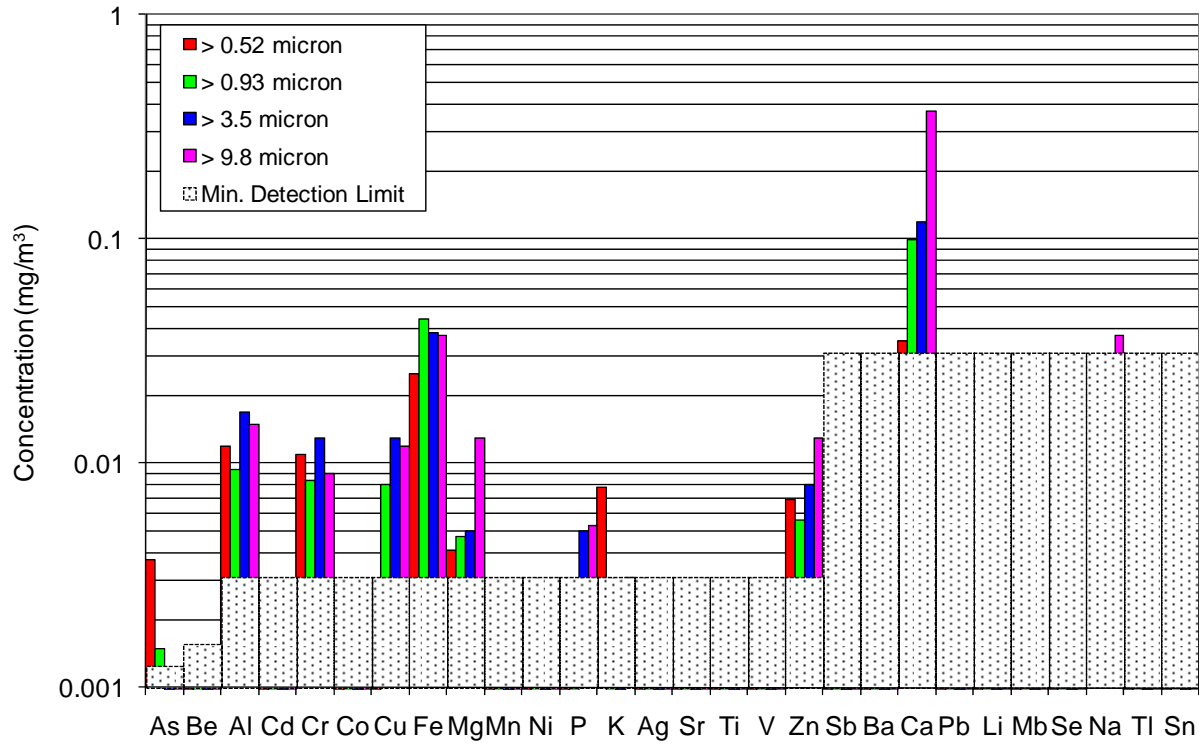
Analysis of the smoke particles accumulated on the four personal cascade impactor cut plates (0.52, 0.93, 3.5, 9.8 micron) worn by the two firefighters, Table 4-38, reveals that the relative mass distributions for the two firefighters are quite different, presumably due to the individual activities being performed.

**Table 4-38: Mass distribution of smoke particles collected on personal cascade impactors during overhaul of the composite deck fire.**

| Particle Size | % Mass Fraction |                |
|---------------|-----------------|----------------|
|               | Firefighter #1  | Firefighter #2 |
| > 0.52 micron | 6.7             | 12.9           |
| > 0.93 micron | 13.4            | 32.9           |
| > 3.5 micron  | 6.7             | 34.9           |
| > 9.8 micron  | 73.3            | 19.3           |

### Personal Air Sampling – Smoke Particle Inorganic Content

Inorganic elemental analysis of the smoke particulates collected with the personal impactor worn by the firefighters are plotted in Figure 4-70. Calcium was found to be most prevalent followed by iron, copper, aluminum, chromium, and zinc. Magnesium, phosphorus, potassium, and sodium were found to a lesser degree. Arsenic was also found in the smaller particles collected for both firefighters.



**Figure 4-70: Inorganic element concentrations measured for smoke particles collected with personal cascade impactors during overhaul of the composite deck fire.**

### Effluent Gas Composition – Area Stands

Average airborne benzene, styrene, and formaldehyde concentrations in the deck vicinity were determined using the using the collection tubes on an area sampling stand. Benzene and styrene levels were found to be comparable to the wood deck structure fire. The lower formaldehyde concentrations were expected given the reduced wood fuel load in the composite deck structure due to substitution of treated wood deck boards with wood-plastic composite deck boards. Results for the stand are summarized in Table 4-39.

**Table 4-39: Gas concentrations collected with area sampling stand during overhaul of the composite deck fire.**

| Species      | Detection Limit (µg) | Sampling Stand |               |
|--------------|----------------------|----------------|---------------|
|              |                      | Mass (µg)      | Concentration |
| Benzene      | 1.1                  | 1.3            | 0.063 ppm     |
| Styrene      | 1.2                  | < 1.3          | < 0.048 ppm   |
| Formaldehyde | 0.1                  | 1.3            | 0.13 ppm      |

### 4.3.8 Automobile Passenger Compartment

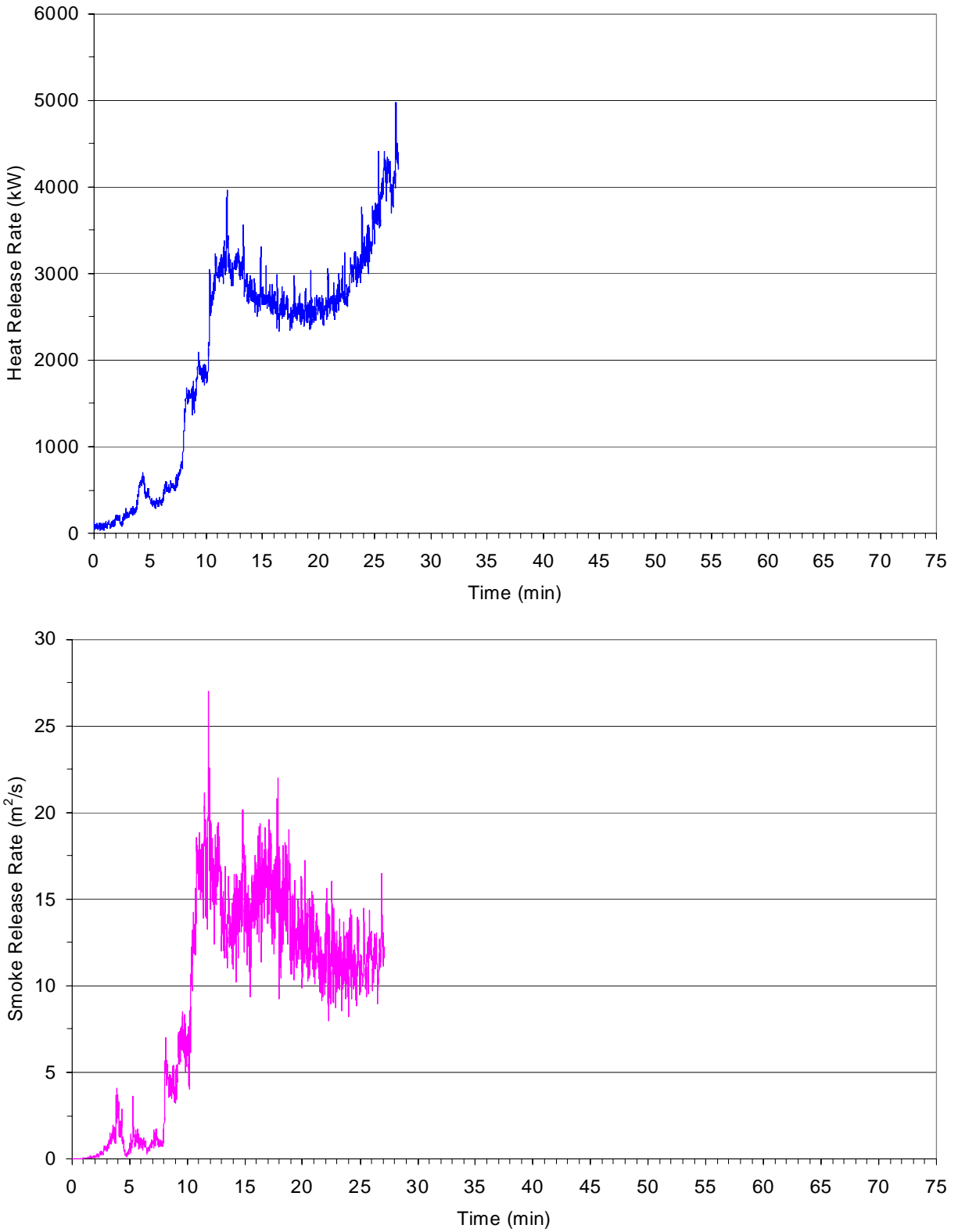
Within 30 seconds of ignition in the radio bay of the front console, the fire spread to the front passenger seat. Less than 1 ½ minutes later the passenger compartment was full of grayish-black colored smoke. Approximately 1 minute later, 3:10 minutes after ignition, the front console started to melt; 40 seconds later flames were extending out of the partially open driver's side window. Within 6 minutes of ignition, the integrity of the windshield was violated with flame penetration around the seals; within 2 additional minutes the windshield cracked. The side windows shattered during the next 2 minutes. Approximately ½ minutes later, 11:23 after ignition, the airbags deployed and burst sending forth scintillating shrapnel, Figure 4-71. By the time suppression was started, 27 minutes after ignition, the passenger compartment was burned out, the exterior body paint and plastic trim had burned off, and the engine bay and tires were engaged in the fire. The fire was then teased for 5 minutes prior to full suppression and overhaul.



Figure 4-71: Scintillating shrapnel resulting from air bag deployment during the passenger compartment fire.

### Heat and Smoke Release Rates

Graphs of the heat and smoke release rates for the attic fire scenario are shown in Figure 4-72. Heat release rate steadily increased to 300 kW during the first 4 minutes of the fire and then briefly increased to 700 kW before returning the initial growth rate for another minute. The HRR accelerated during the next 2 minutes (8 minutes after ignition) to 750 kW before rapidly accelerating to greater than 3 MW. The two HRR “humps” at approximately 9 and 10 minutes after ignition correspond to when the side windows shattered. HRR eventually reached almost 5 MW prior to commencing suppression. Smoke production correspondingly followed the heat production with accelerating smoke production for the first 4 minutes during which the passenger compartment filled with the grayish-black colored smoke and the smoke started to escape. SRR plateaus at approximately 9 and 10 minutes corresponding to the side windows shattering. Within 11 minutes of ignition, SRR exceeded 15 m<sup>2</sup>/s and did not fall below 10 m<sup>2</sup>/s for the remainder of the fire growth phase.

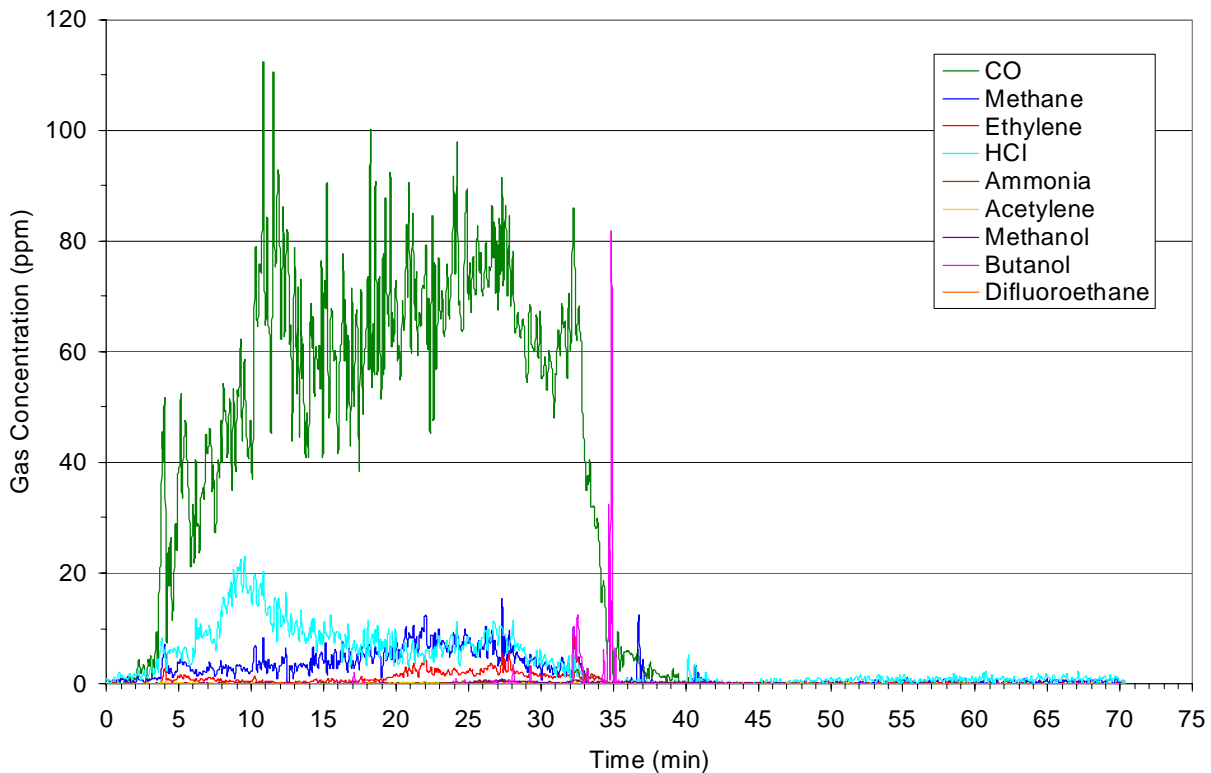


**Figure 4-72: Heat (top) and smoke release rate (bottom) during the fire growth phase of the passenger compartment fire.**



### Effluent Gas Composition – OP-FTIR

Concentrations of gases in the smoke plume above the automobile were measured by OP-FTIR for the duration of the fire test. Results for gases other than water and carbon dioxide are plotted in Figure 4-73. During the initial 3½ minutes of fire growth (when the fire was essentially contained in the passenger compartment) the gas concentrations were below 5 ppm. Once flames extended out of the driver's side window, gas concentrations steadily increased as the interior was consumed. Approximately 11 minutes after ignition, carbon monoxide concentrations reached as high as 95 ppm, and then varied between 60 to 80 ppm until suppression commenced. Hydrogen chloride gas increased to almost 23 ppm within 10 minutes of ignition and then gradually decreased to less than 7 ppm by suppression; other gases however steadily increased throughout the fire growth phase until suppression started, though concentrations remained less than 10 ppm. Once suppression was essentially completed, approximately 35 minutes after ignition, gas concentrations were reduced to less than 5 ppm for carbon monoxide and less than 1 ppm for the others. The single exception to these trends was butanol which spiked at about the time suppression was completed and the hood was unlatched.



**Figure 4-73: Gas concentration measured by OP-FTIR for the passenger compartment fire.**

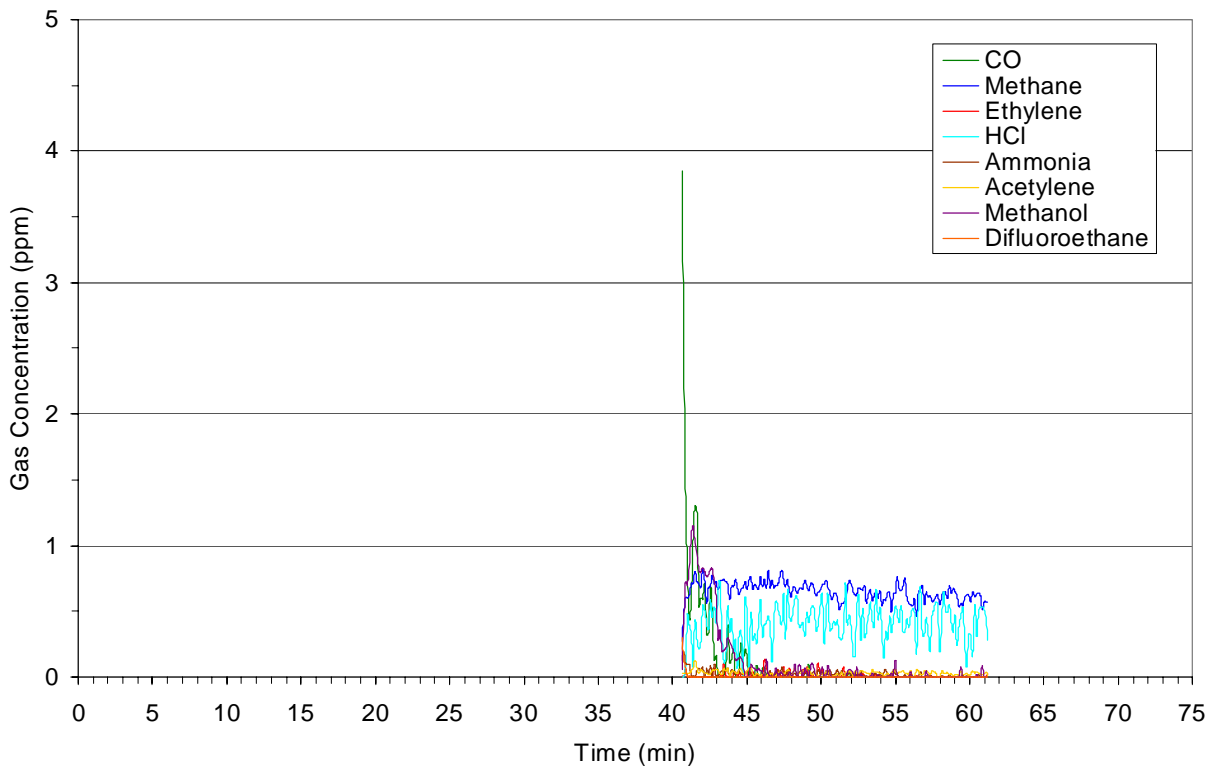
Peak gas concentrations and calculated total exposures are summarized in Table 4-40.

**Table 4-40: Summary of OP-FTIR gas concentration data for the passenger compartment fire.**

| Gas            | Peak concentration (ppm) | Total exposure (ppm-min) |
|----------------|--------------------------|--------------------------|
| CO             | 112.0                    | 1848.7                   |
| Methane        | 15.5                     | 148.4                    |
| Ethylene       | 8.5                      | 42.5                     |
| HCl            | 22.9                     | 264.3                    |
| Ammonia        | 2.8                      | 9.1                      |
| Acetylene      | 0.5                      | 3.3                      |
| Methanol       | 0.8                      | 7.2                      |
| Butanol        | 81.8                     | 19.3                     |
| Difluoroethane | 0.2                      | 0.5                      |

**Effluent Gas Composition – Extractive FTIR**

Concentrations of gases in the vicinity of the driver’s window were measured by extractive FTIR during overhaul. Results for gases other than water and carbon dioxide are plotted in Figure 4-74. Gas concentrations were comparable to those measured above the vehicle with the OP-FTIR, less than 1 ppm.



**Figure 4-74: Gas concentration measured by extractive FTIR during overhaul of the passenger compartment fire.**

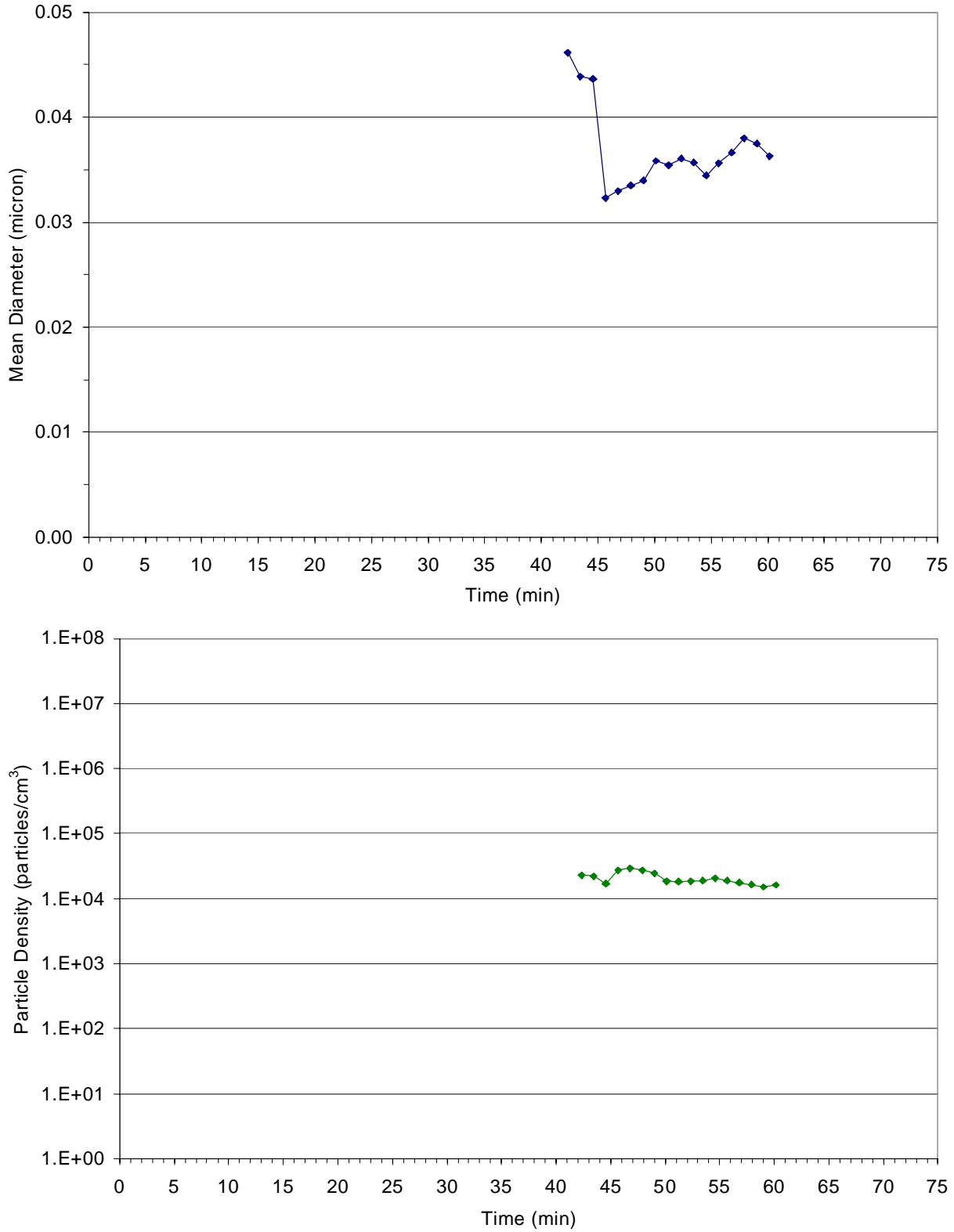
Peak gas concentrations and calculated total exposures are summarized in Table 4-41.

**Table 4-41: Summary of extractive FTIR gas concentration data for overhaul of the passenger compartment fire.**

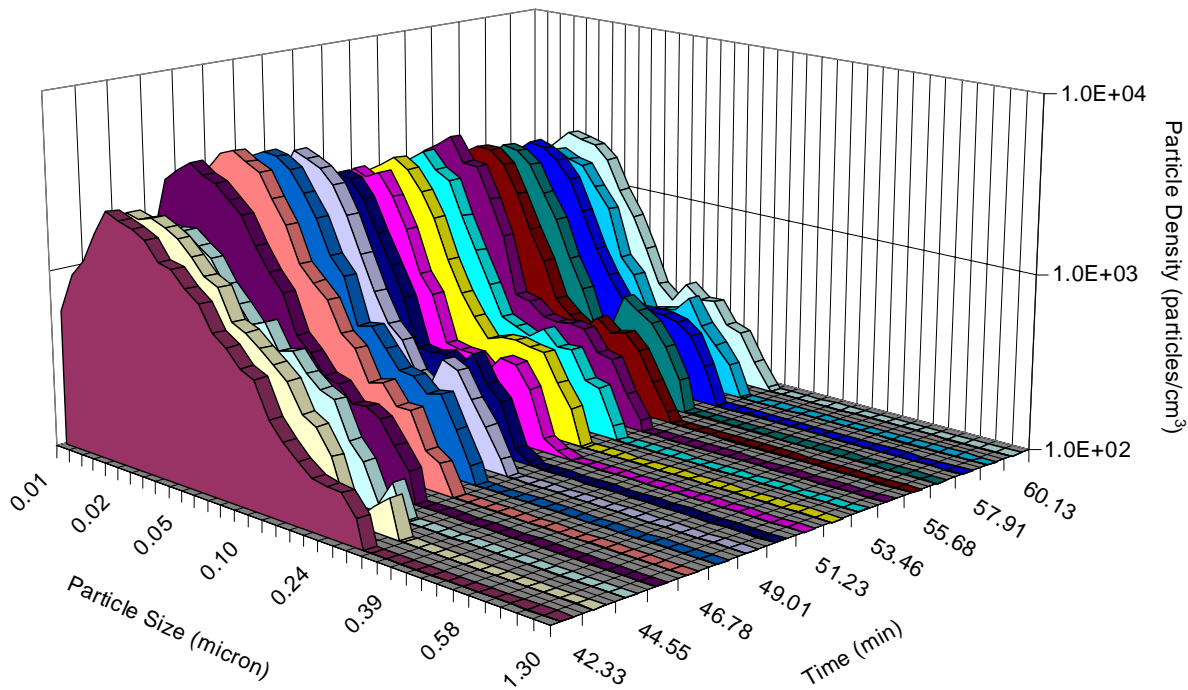
| Gas            | Peak concentration (ppm) | Total exposure (ppm-min) |
|----------------|--------------------------|--------------------------|
| CO             | 3.9                      | 2.4                      |
| Methane        | 0.8                      | 13.5                     |
| Ethylene       | 0.1                      | 0.2                      |
| HCl            | 0.7                      | 8.4                      |
| Ammonia        | 0.2                      | 0.5                      |
| Acetylene      | 0.1                      | 0.7                      |
| Methanol       | 1.2                      | 2.6                      |
| Difluoroethane | 0.3                      | 0.0                      |

**Smoke Particle Analyzer**

The average smoke particle size and particle count density in the vicinity of the driver's window during the last 15 minutes of overhaul, as characterized with the WPS spectrometer, is depicted in Figure 4-75. The average smoke particle size was comparable to "normal clean" air at  $0.035 \pm 0.002$  microns. Smoke particle count density remained fairly steady at  $20,600 \pm 4,700$  particles per cubic centimeter. As seen in Figure 4-76, the particle size distribution remained consistent throughout the measurement period.



**Figure 4-75: Smoke particle average size (top) and count density (bottom) measured with the particle analyzer during overhaul of the passenger compartment fire.**



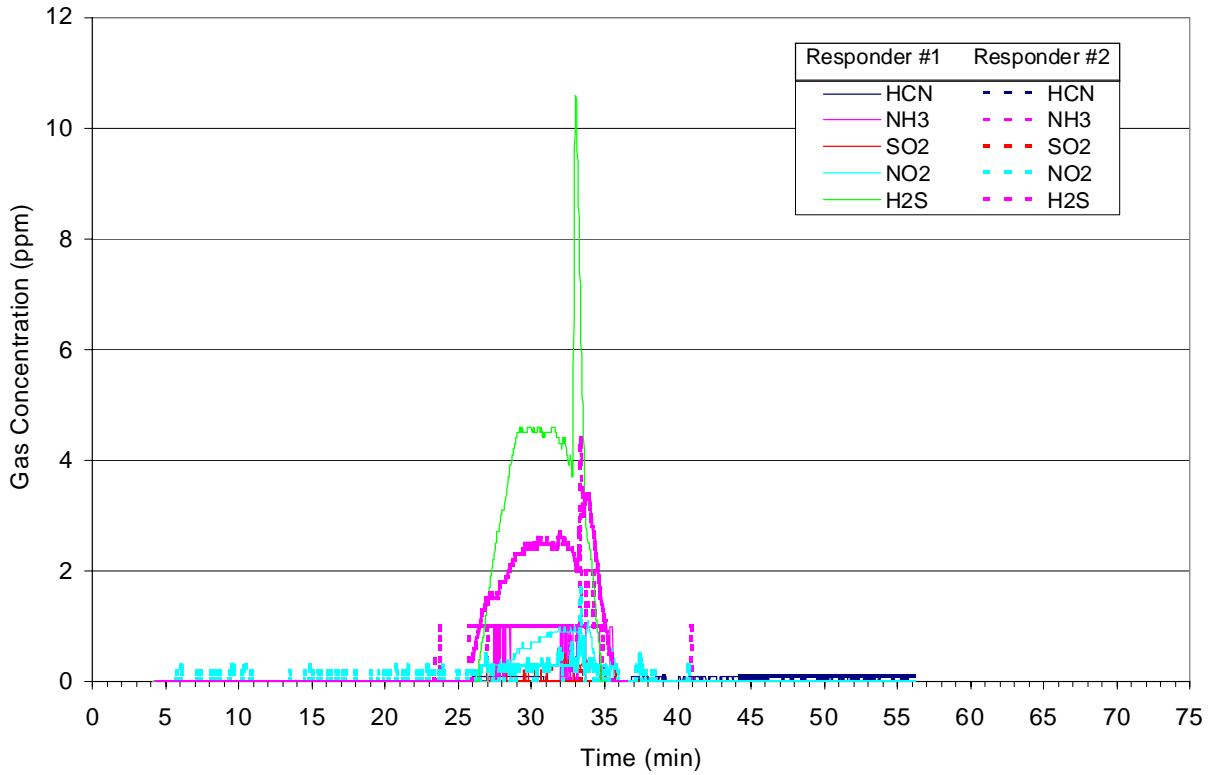
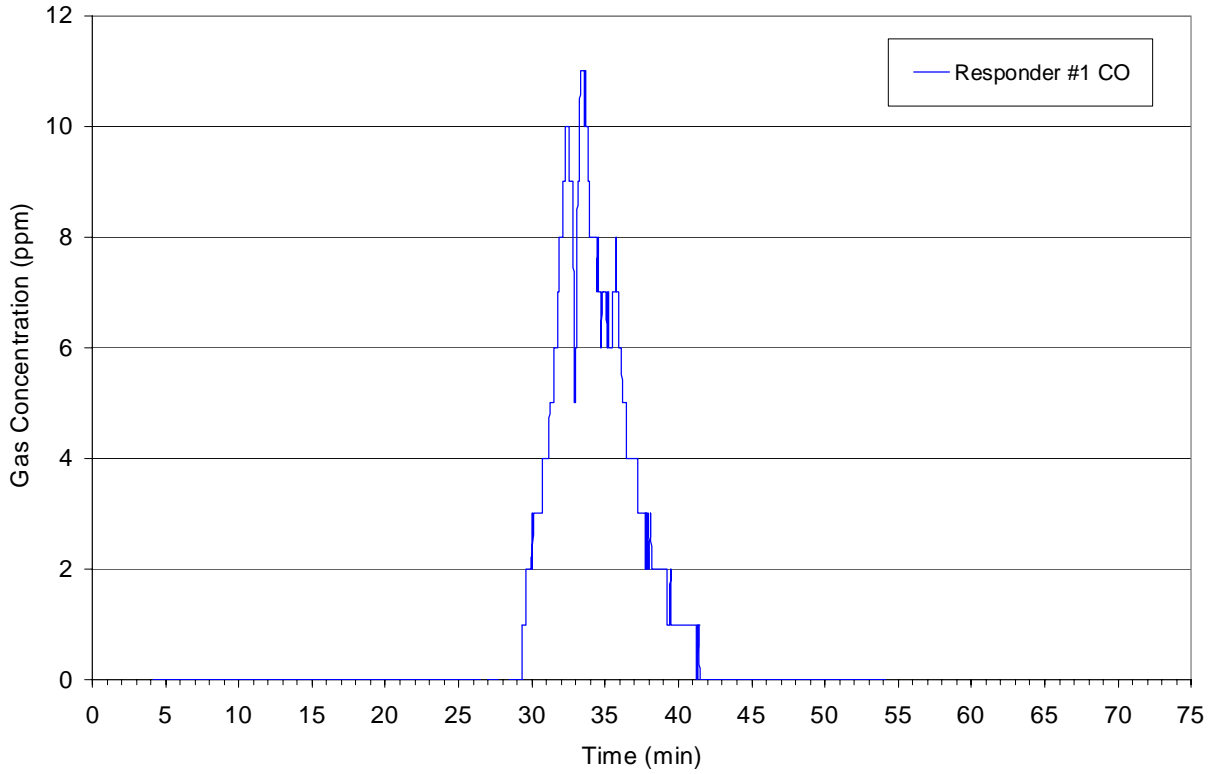
**Figure 4-76: Smoke particle size distribution measured with the particle analyzer during overhaul of the passenger compartment fire.**

### Smoke Particle Size Distribution

Unfortunate smoke plume formation relative to the sampling location for the high flow bench-top cascade impactor resulted in insufficient collected particles for gravimetric detection ( $< 100 \mu\text{g}$ ).

### Personal Air Sampling – Gas

Two firefighters wore personal gas monitors during overhaul operations. The carbon monoxide sensor in the gas monitor worn by Responder #2 failed to operate. Measured gas concentrations are plotted in Figure 4-77. Carbon monoxide levels for the operating sensor were comparable to concentrations measured using the OP-FTIR. Spikes in hydrogen sulfide concentration correspond to overhaul activity near the front of the car where multiple rubber components such as belts, hoses, and tires were engaged in the fire.



**Figure 4-77: Gas concentrations measured by personal monitors during overhaul of the passenger compartment fire.**

Peak gas concentrations and calculated total exposures for the two firefighters are summarized in Table 4-42.

**Table 4-42: Summary of personal gas monitor data for overhaul of the passenger compartment fire.**

| Gas              | Responder #1             |                          | Responder #2             |                          |
|------------------|--------------------------|--------------------------|--------------------------|--------------------------|
|                  | Peak concentration (ppm) | Total exposure (ppm-min) | Peak concentration (ppm) | Total exposure (ppm-min) |
| HCN              | 0.2                      | 0.8                      | 0.1                      | 0.0                      |
| NH <sub>3</sub>  | 1.0                      | 6.2                      | 3.0                      | 9.5                      |
| SO <sub>2</sub>  | 0.6                      | 1.4                      | 0.2                      | 0.0                      |
| NO <sub>2</sub>  | 1.1                      | 5.1                      | 1.7                      | 3.2                      |
| H <sub>2</sub> S | 10.6                     | 31.5                     | 4.4                      | 20.1                     |
| CO               | 11.0                     | 54.9                     | failed                   | failed                   |

### Effluent Gas Composition – Area Stands

Average airborne benzene, styrene, formaldehyde, and PAHs concentrations in the vicinity of the front of the car were determined using the collection tubes on area sampling stands. One stand sampled throughout the test and the other stand sampled during the overhaul operation period. Results for the two stands are summarized in Table 4-43. The sole detected airborne PAH, naphthalene, was found to be at lower concentrations during overhaul than the previous test periods.

**Table 4-43: Gas concentrations collected with area sampling stand during the passenger compartment fire.**

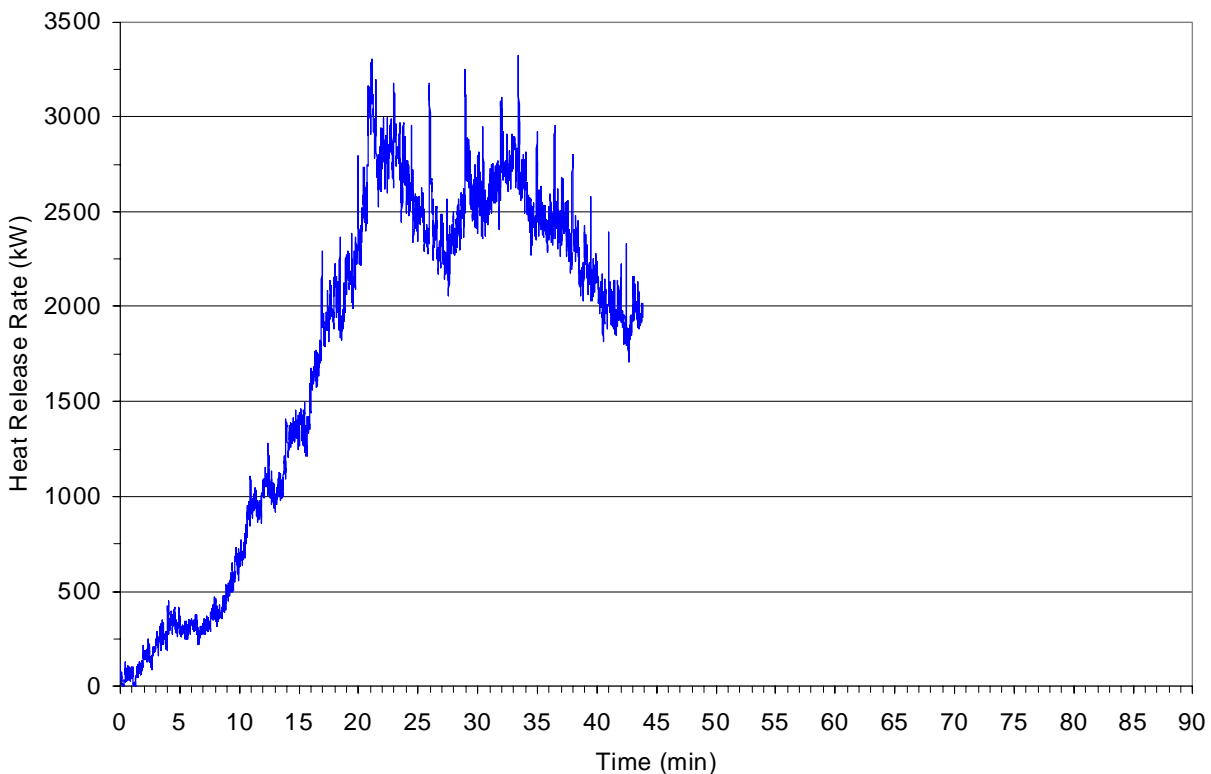
| Species                | Detection Limit (µg) | Sampling Stand: total fire |                            | Sampling Stand: overhaul |                            |
|------------------------|----------------------|----------------------------|----------------------------|--------------------------|----------------------------|
|                        |                      | Mass (µg)                  | Concentration              | Mass (µg)                | Concentration              |
| Benzene                | 1.1                  | < 1.1                      | < 0.027 ppm                | < 1.1                    | < 0.065 ppm                |
| Styrene                | 1.3                  | < 1.4                      | < 0.026 ppm                | < 1.4                    | < 0.06 ppm                 |
| Formaldehyde           | 0.1                  | 0.13                       | 0.0068 ppm                 | 0.19                     | 0.024 ppm                  |
| Acenaphthylene         | < 0.1                | < 0.1                      | < 0.0017 mg/m <sup>3</sup> | < 0.1                    | < 0.0039 mg/m <sup>3</sup> |
| Acenaphthene           | < 0.1                | < 0.1                      | < 0.0017 mg/m <sup>3</sup> | < 0.1                    | < 0.0039 mg/m <sup>3</sup> |
| Anthracene             | < 0.1                | < 0.1                      | < 0.0017 mg/m <sup>3</sup> | < 0.1                    | < 0.0039 mg/m <sup>3</sup> |
| Benzo(a)anthracene     | < 0.1                | < 0.1                      | < 0.0017 mg/m <sup>3</sup> | < 0.1                    | < 0.0039 mg/m <sup>3</sup> |
| Benzo (a)pyrene        | < 0.1                | < 0.1                      | < 0.0017 mg/m <sup>3</sup> | < 0.1                    | < 0.0039 mg/m <sup>3</sup> |
| Benzo(b)fluoranthene   | < 0.1                | < 0.1                      | < 0.0017 mg/m <sup>3</sup> | < 0.1                    | < 0.0039 mg/m <sup>3</sup> |
| Benzo(k)fluoranthene   | < 0.1                | < 0.1                      | < 0.0017 mg/m <sup>3</sup> | < 0.1                    | < 0.0039 mg/m <sup>3</sup> |
| Benzo(ghi)perylene     | < 0.1                | < 0.1                      | < 0.0017 mg/m <sup>3</sup> | < 0.1                    | < 0.0039 mg/m <sup>3</sup> |
| Chrysene               | < 0.1                | < 0.1                      | < 0.0017 mg/m <sup>3</sup> | < 0.1                    | < 0.0039 mg/m <sup>3</sup> |
| Dibenzo(a,h)anthracene | < 0.1                | < 0.1                      | < 0.0017 mg/m <sup>3</sup> | < 0.1                    | < 0.0039 mg/m <sup>3</sup> |
| Fluoranthene           | < 0.1                | < 0.1                      | < 0.0017 mg/m <sup>3</sup> | < 0.1                    | < 0.0039 mg/m <sup>3</sup> |
| Fluorene               | < 0.1                | < 0.1                      | < 0.0017 mg/m <sup>3</sup> | < 0.1                    | < 0.0039 mg/m <sup>3</sup> |
| Indeno(1,2,3-cd)pyrene | < 0.1                | < 0.1                      | < 0.0017 mg/m <sup>3</sup> | < 0.1                    | < 0.0039 mg/m <sup>3</sup> |
| Naphthalene            | < 0.1                | 0.84                       | 0.014 mg/m <sup>3</sup>    | 0.1                      | 0.0038 mg/m <sup>3</sup>   |
| Phenanthrene           | < 0.1                | < 0.1                      | < 0.0017 mg/m <sup>3</sup> | < 0.1                    | < 0.0039 mg/m <sup>3</sup> |
| Pyrene                 | < 0.1                | < 0.1                      | < 0.0017 mg/m <sup>3</sup> | < 0.1                    | < 0.0039 mg/m <sup>3</sup> |

### 4.3.9 Automobile Engine Compartment

Within 1 minute of ignition flames were extending from under the hood; 2:10 minutes later the fire had spread to the paint on the hood and the passenger front tire. The front bumper began to melt and fall away from the body 6 minutes later. Flames were observed inside of the passenger compartment within an additional minute (10:50 minutes after ignition). Within 2 ½ minutes the passenger compartment was full of gray smoke. The front of the automobile was engulfed in flames 17:16 minutes after ignition. One of the airbags detonated at 23:41 minutes after ignition causing the trunk lid to open and shut. By the time suppression was started, 43:50 minutes after ignition, the engine bay and passenger compartment were burned out, the exterior body paint and plastic trim had burned off, and the tires were engaged in the fire. The fire was then teased for 5 minutes prior to full suppression and overhaul.

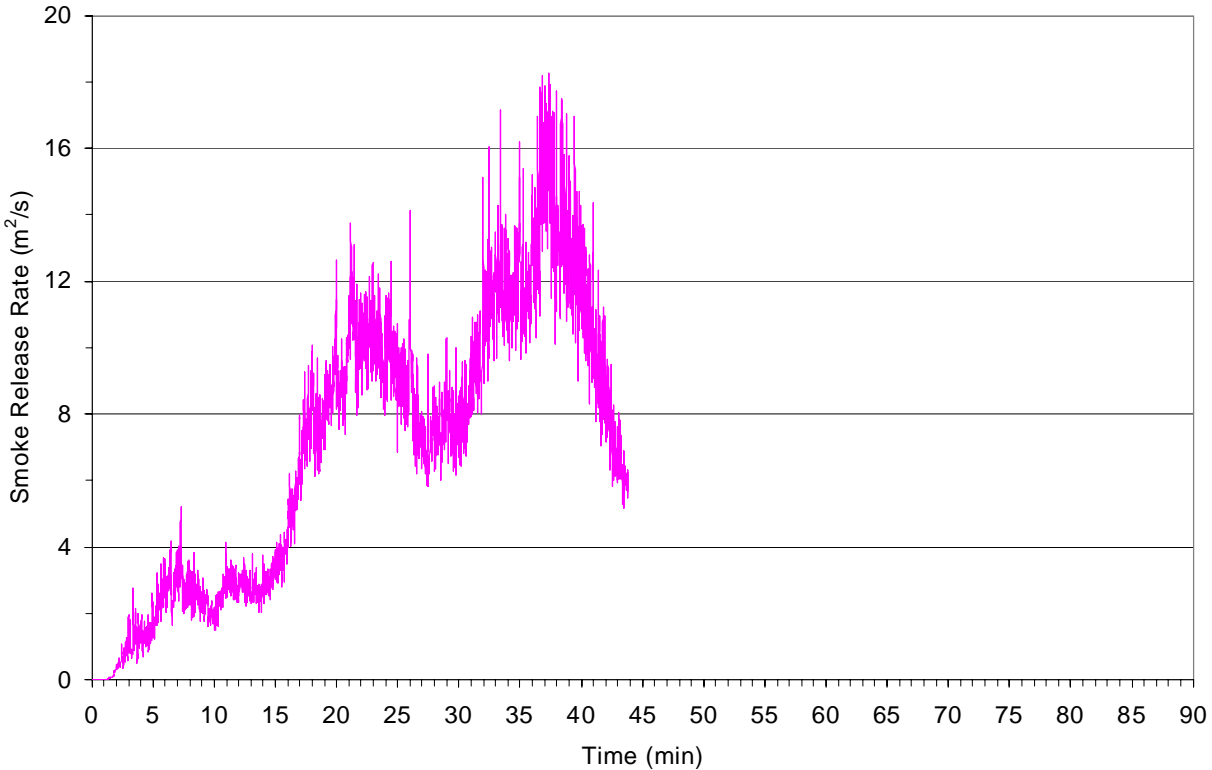
### Heat and Smoke Release Rates

Graphs of the heat and smoke release rates for the attic fire scenario are shown in Figure 4-83 and Figure 4-79 respectively. HRR steadily increased to 2.9 MW during the first 23 minutes of the fire, by which time the passenger compartment was fully engaged. As the fuel load in the passenger compartment was consumed, the HRR decreased to 2.3 MW before breaching into the trunk compartment where the additional fuel load allowed HRR to climb back to 2.8 MW. Once the trunk fuel load was consumed, the HRR steadily decreased to 2 MW prior suppression commencing. Smoke production exhibits essentially the same behavior: SRR steadily increases for the first 7½ minutes to 3 m<sup>2</sup>/s and then over the next 8 minutes remains between 2 and 3 m<sup>2</sup>/s. As the fire engages the passenger compartment the SRR increases to more than 10 m<sup>2</sup>/s and then decreases and increases as fuel load and smoke escape paths become available.



**Figure 4-78: Heat release rate during the fire growth phase of the engine compartment fire.**

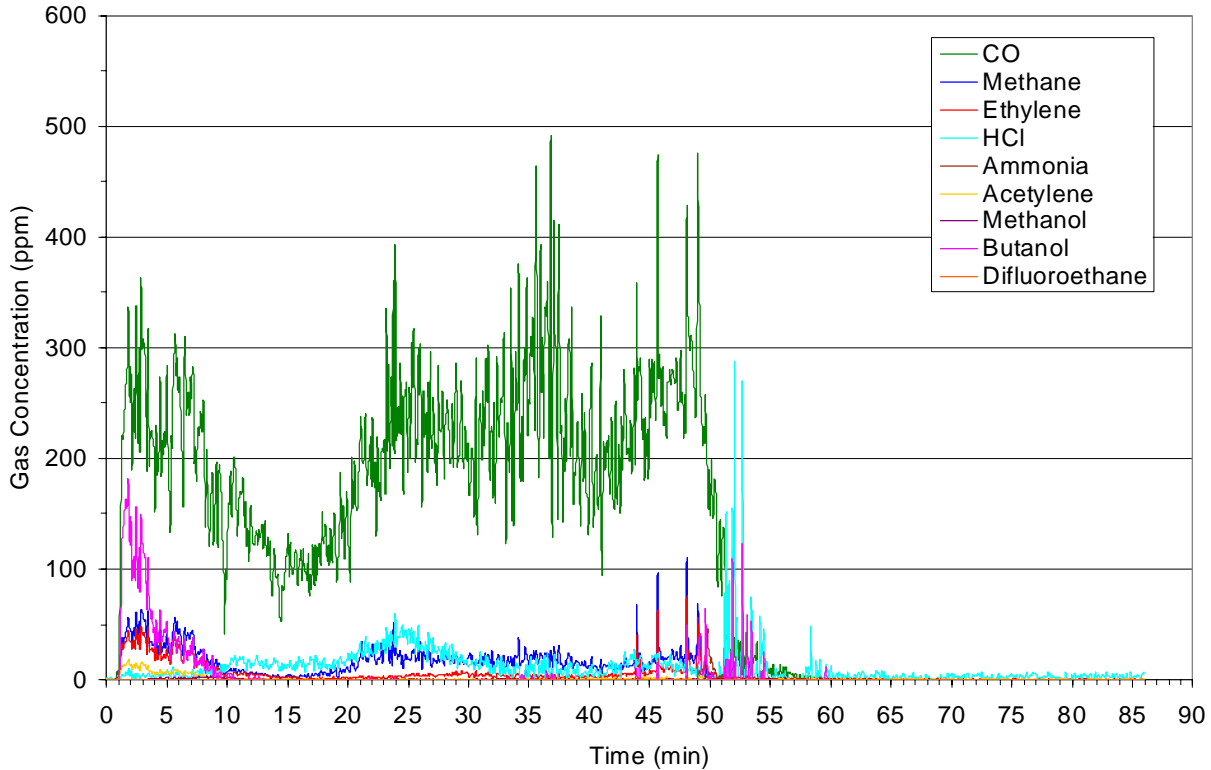




**Figure 4-79: Smoke release rate during the fire growth phase of the engine compartment fire.**

### **Effluent Gas Composition – OP-FTIR**

Concentrations of gases in the smoke plume above the automobile were measured by OP-FTIR for the duration of the fire test. Results for gases other than water and carbon dioxide are plotted in Figure 4-80. Gas concentrations remained relatively constant throughout the fire growth phase with the exception of the initial 5 minutes in which elevated hydrocarbon concentrations, particularly butanol, were detected. There was also a marked increase in hydrogen chloride gas concentration at about the same time as the fire progressed through the passenger compartment. About the time when the hood was pried open there was a 3 minute increase in butanol and hydrogen chloride gas concentrations. Once the trunk was also vented gas concentrations were reduced to less than 10 ppm.



**Figure 4-80: Gas concentration measured by OP-FTIR for the engine compartment fire.**

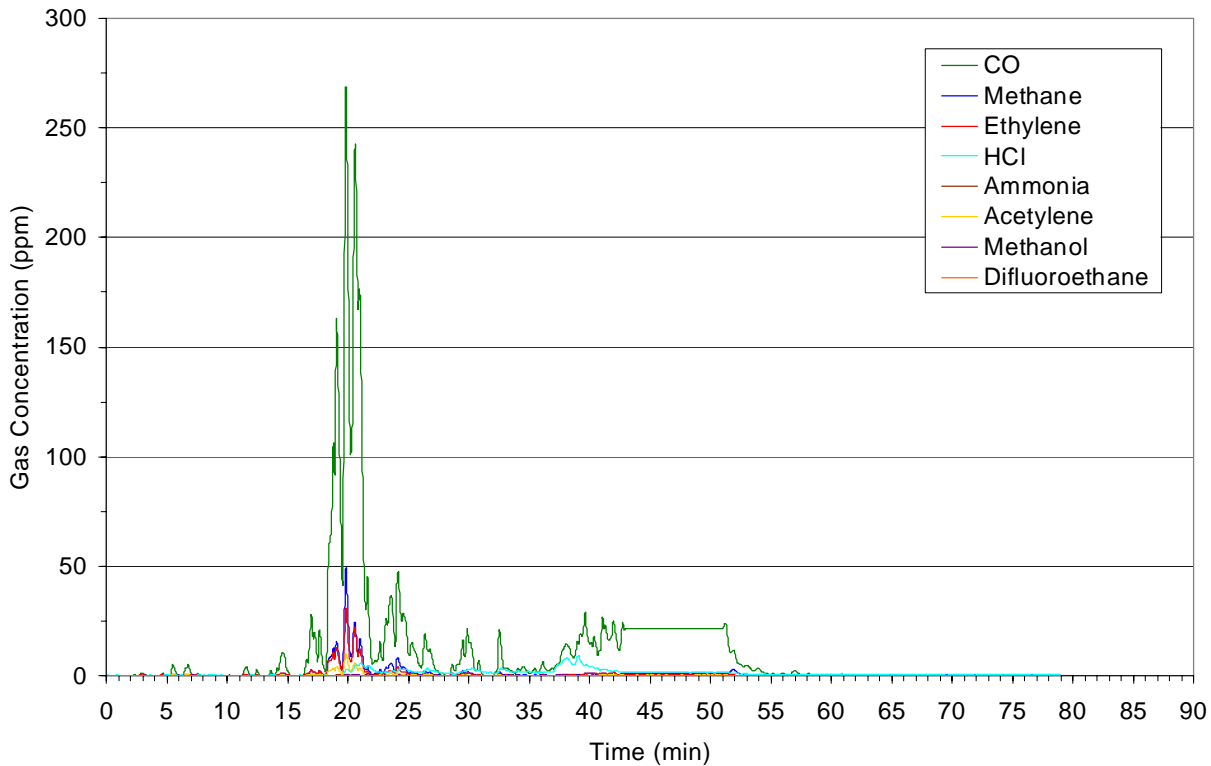
Peak gas concentrations and calculated total exposures are summarized in Table 4-44.

**Table 4-44: Summary of OP-FTIR gas concentration data for the engine compartment fire.**

| Gas            | Peak concentration (ppm) | Total exposure (ppm-min) |
|----------------|--------------------------|--------------------------|
| CO             | 491.9                    | 10,492.4                 |
| Methane        | 110.0                    | 915.3                    |
| Ethylene       | 75.4                     | 420.3                    |
| HCl            | 286.8                    | 930.2                    |
| Ammonia        | 46.0                     | 48.6                     |
| Acetylene      | 17.9                     | 92.4                     |
| Methanol       | 4.2                      | 25.8                     |
| Butanol        | 181.6                    | 521.4                    |
| Difluoroethane | 0.5                      | 6.9                      |

**Effluent Gas Composition – Extractive FTIR**

Concentrations of gases in the vicinity of the hood on the driver’s side were measured by extractive FTIR for the duration of the fire test. Results for gases other than water and carbon dioxide are plotted in Figure 4-81. Carbon monoxide and other gas concentrations are considerably lower than those measured with the OP-FTIR suggesting the bulk of gases produced do not come from the fire in the engine compartment.



**Figure 4-81: Gas concentration measured by extractive FTIR for the engine compartment fire.**

Peak gas concentrations and calculated total exposures are summarized in Table 4-45.

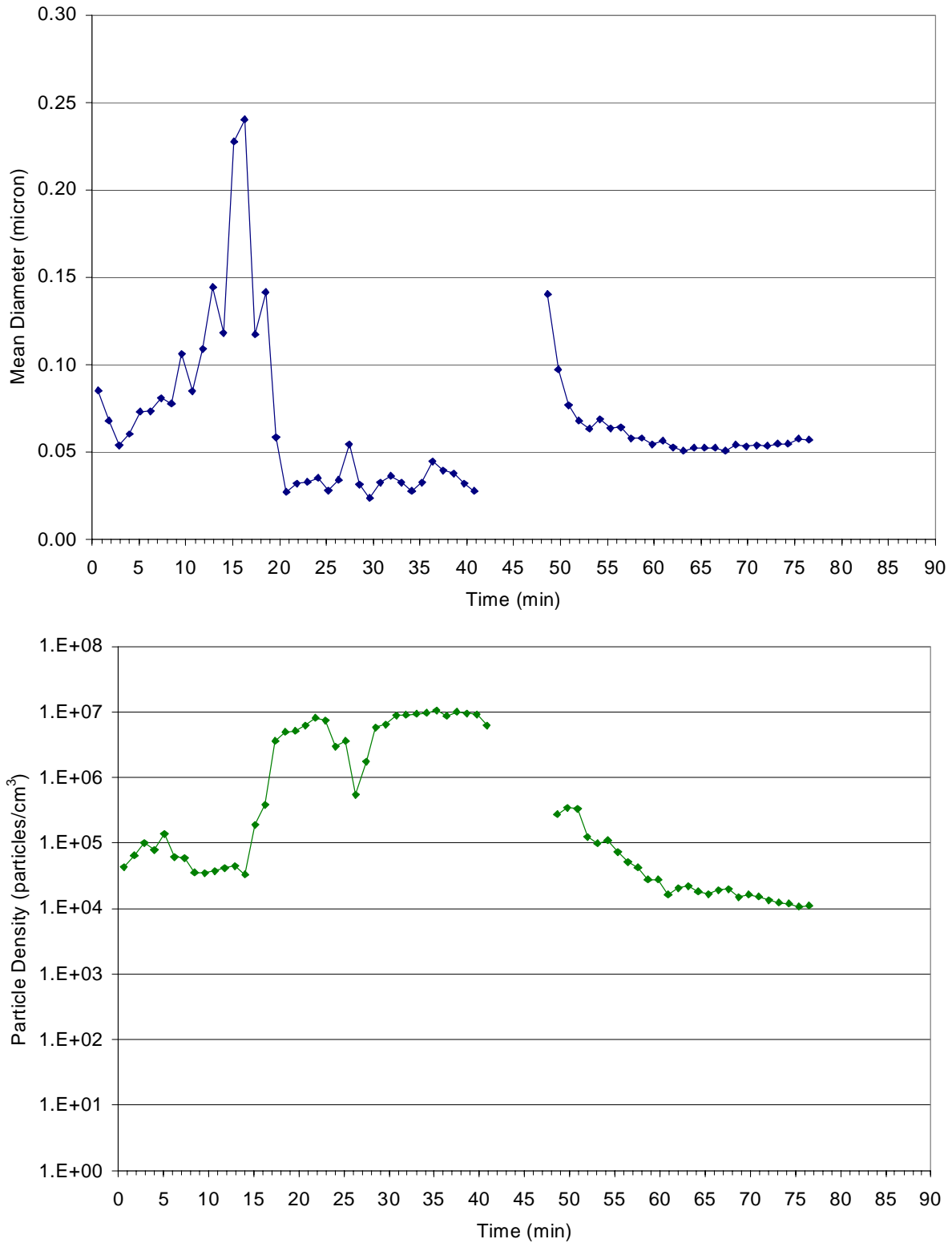
**Table 4-45: Summary of extractive FTIR gas concentration data for the engine compartment fire.**

| Gas            | Fire Growth until suppression |                          | Suppression on           |                          |
|----------------|-------------------------------|--------------------------|--------------------------|--------------------------|
|                | Peak concentration (ppm)      | Total exposure (ppm-min) | Peak concentration (ppm) | Total exposure (ppm-min) |
| CO             | 266.4                         | 688.3                    | 23.7                     | 190.5                    |
| Methane        | 48.6                          | 71.0                     | 3.1                      | 20.5                     |
| Ethylene       | 30.5                          | 52.4                     | 0.7                      | 6.3                      |
| HCl            | 8.9                           | 67.2                     | 1.9                      | 27.3                     |
| Ammonia        | 0.5                           | 1.5                      | 0.0                      | 0.0                      |
| Acetylene      | 9.9                           | 17.5                     | 0.3                      | 2.4                      |
| Methanol       | 1.0                           | 6.2                      | 0.2                      | 1.7                      |
| Difluoroethane | 0.0                           | 0.0                      | 0.0                      | 0.1                      |

**Smoke Particle Analyzer**

The average smoke particle size and particle count density in the vicinity of the hood on the driver’s side, as characterized with the WPS spectrometer, is depicted in Figure 4-51. As the fire engulfed the front end of the vehicle during the first 17 minutes of the test, the average smoke particle size increased to as large as 0.24 microns and the particle count increased by an order of magnitude. Propagation of the flame front away from the sampling probe and into the passenger compartment where small particle producing polyurethane foam was engaged, led to the reduced average particle sizes and 1½ order increase in particle count density. As seen in the plot of the

particle size distribution, Figure 4-52, the distribution of smoke particles varied considerably depending on the material burning and its location relative to the sampling probe.



**Figure 4-82: Smoke particle average size (top) and count density (bottom) measured with the particle analyzer for the engine compartment fire. Data gap corresponds to suppression at the sampling probe.**

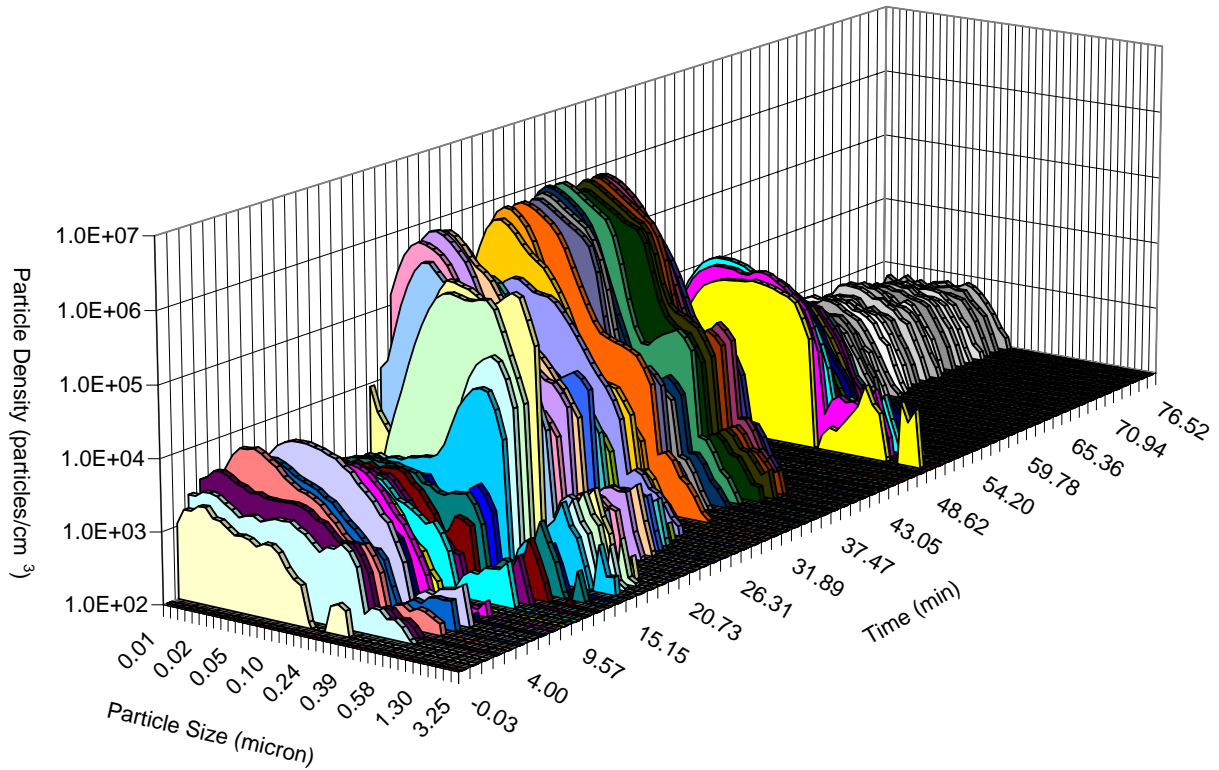


Figure 4-83: Smoke particle size distribution measured with the particle analyzer for the engine compartment fire.

**Smoke Particle Size Distribution**

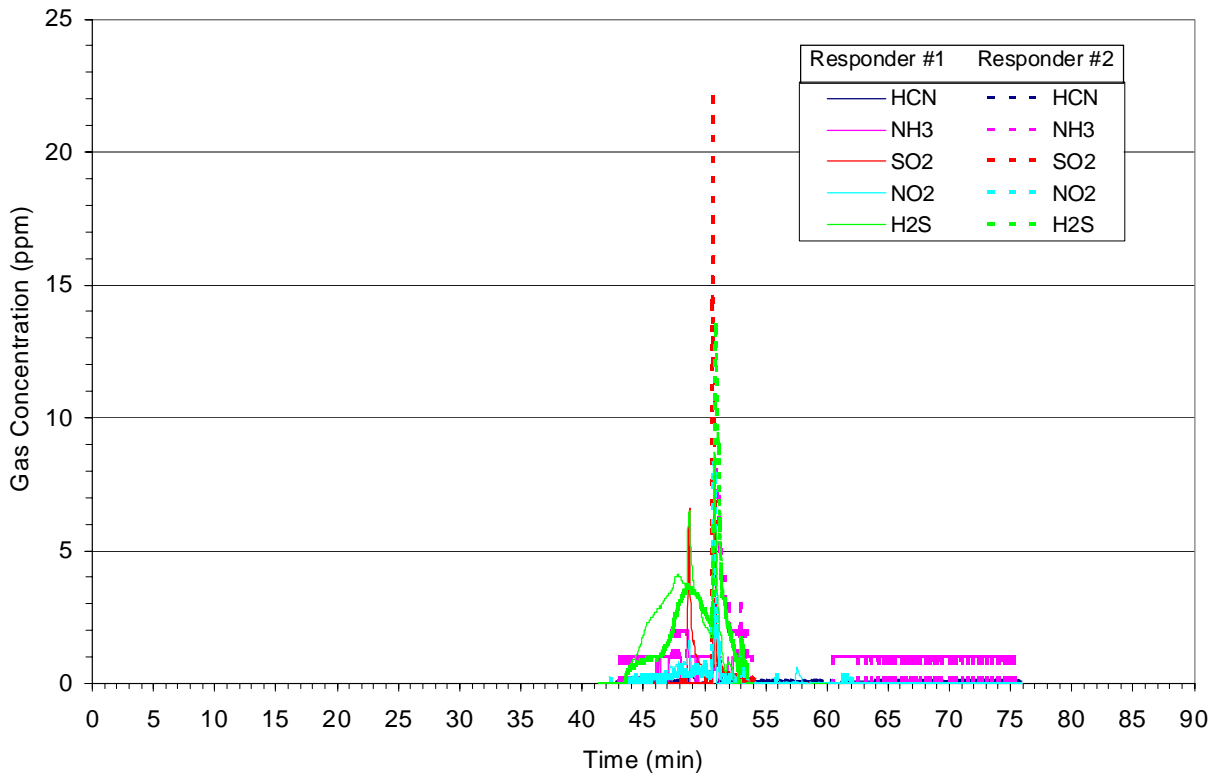
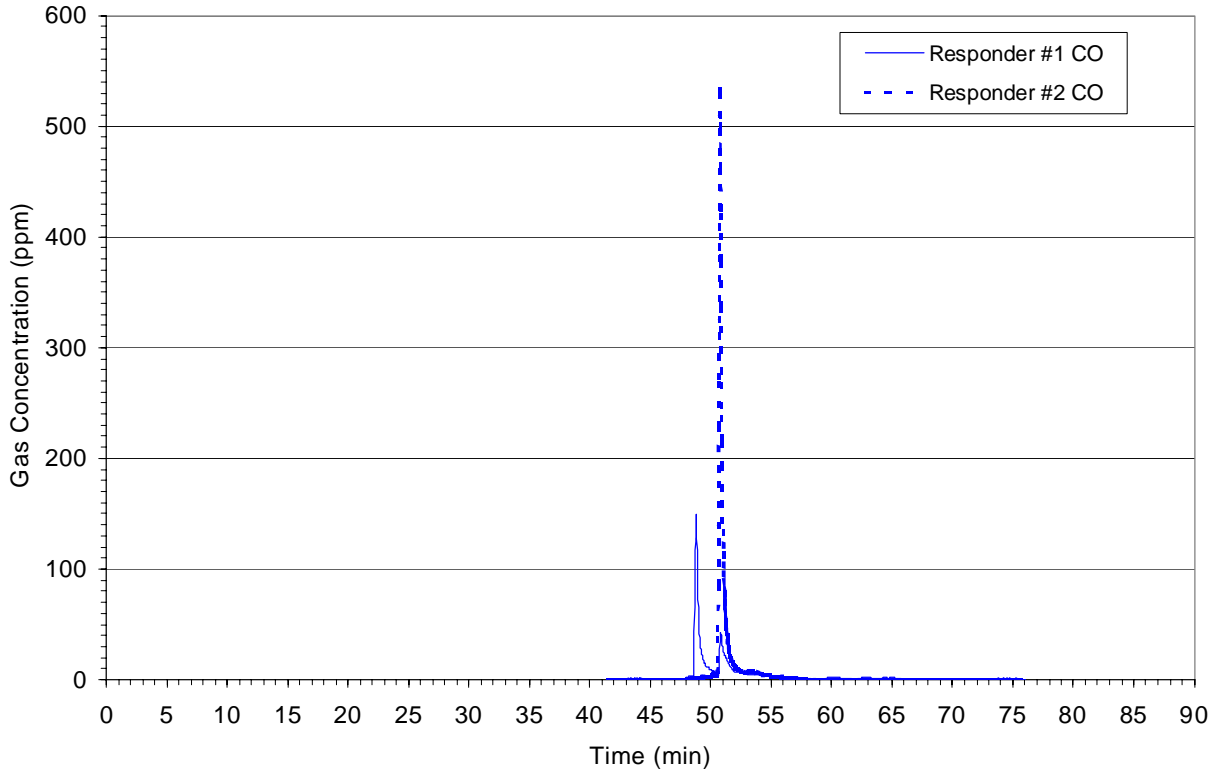
The size distribution of smoke particles during fire growth in the vicinity of the driver’s window was determined using the high flow bench-top cascade impactor. Results summarized in Table 4-46 corroborate the prevalence of submicron-sized particles as measured with the WPS.

Table 4-46: Smoke particle size distribution measured with the bench-top cascade impactor during the fire growth phase of the engine compartment fire.

| Stage No. | Cut Plate (micron) | Particulate Weight (µg) | Fraction of Collected Mass |
|-----------|--------------------|-------------------------|----------------------------|
| 1         | 10                 | <100                    | negligible                 |
| 2         | 2.5                | <100                    | negligible                 |
| 3         | 1                  | 160                     | 0.10%                      |
| 4         | 0.25               | 8440                    | 5.47%                      |
| 5         | Glass fiber filter | 145630                  | 94.42%                     |

**Personal Air Sampling – Gas**

Two firefighters wore personal gas monitors and impactors during overhaul operations. Measured gas concentrations are plotted in Figure 4-84. Note the relatively high concentrations of sulfur dioxide and hydrogen sulfide corresponding to overhaul activity near the front of the car where multiple rubber components such as belts, hoses, and tires were engaged in the fire.



**Figure 4-84: Gas concentrations measured by personal monitors during overhaul of the engine compartment fire.**

Peak gas concentrations and calculated total exposures for the two firefighters are summarized in Table 4-47.

**Table 4-47: Summary of personal gas monitor data for overhaul of the engine compartment fire.**

| Gas              | Responder #1             |                          | Responder #2             |                          |
|------------------|--------------------------|--------------------------|--------------------------|--------------------------|
|                  | Peak concentration (ppm) | Total exposure (ppm-min) | Peak concentration (ppm) | Total exposure (ppm-min) |
| HCN              | 0.5                      | 2.3                      | 0.2                      | 1.2                      |
| NH <sub>3</sub>  | 8.0                      | 3.9                      | 8.0                      | 30.3                     |
| SO <sub>2</sub>  | 6.6                      | 4.4                      | 22.1                     | 4.3                      |
| NO <sub>2</sub>  | 3.0                      | 3.8                      | 8.3                      | 5.1                      |
| H <sub>2</sub> S | 8.7                      | 23.1                     | 13.5                     | 22.9                     |
| CO               | 149.0                    | 118.2                    | 534                      | 196.3                    |

### Personal Air Sampling – Smoke Particle Size Distribution

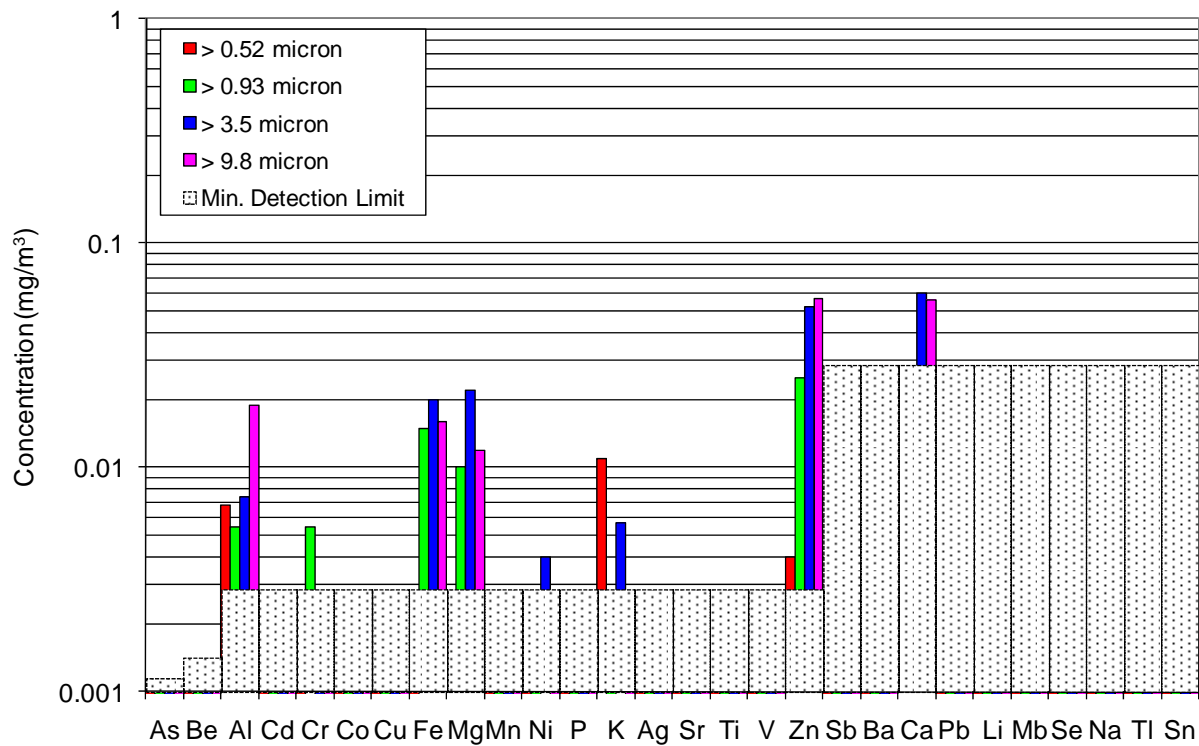
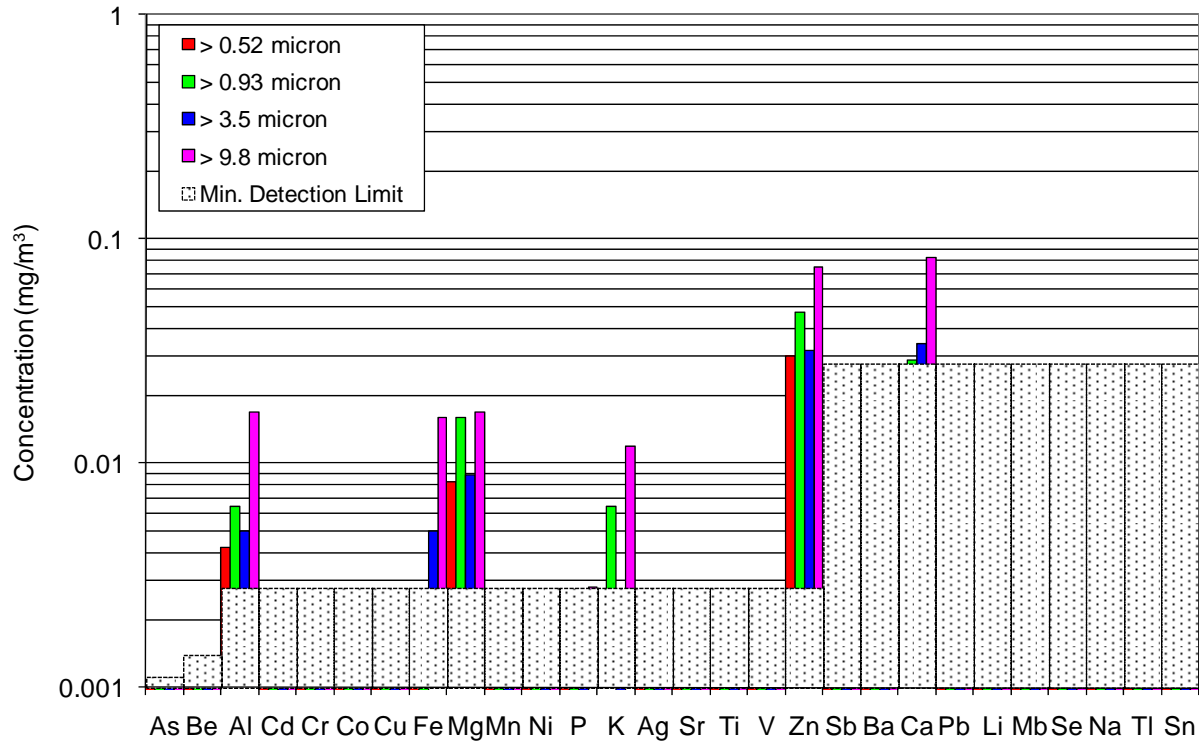
Analysis of the smoke particles accumulated on the four personal cascade impactor cut plates (0.52, 0.93, 3.5, 9.8 micron) worn by the two firefighters, Table 4-48, reveals that the relative smoke particle mass distributions are similar for the two firefighters and the largest particle sizes, greater than 9.8 microns, were prevalent in both cases.

**Table 4-48: Mass distribution of smoke particles collected on personal cascade impactors during overhaul of the engine compartment fire.**

| Particle Size | % Mass Fraction |                |
|---------------|-----------------|----------------|
|               | Firefighter #1  | Firefighter #2 |
| > 0.52 micron | 6.5             | 5.9            |
| > 0.93 micron | 30.4            | 22.4           |
| > 3.5 micron  | 16.4            | 13.9           |
| > 9.8 micron  | 46.7            | 57.8           |

### Personal Air Sampling – Smoke Particle Inorganic Content

Inorganic elemental analysis of the smoke particulates collected with the personal impactor worn by the firefighters are plotted in Figure 4-85. Zinc was found to be most prevalent followed by aluminum, iron, magnesium and calcium. Chromium, nickel, and potassium were found to a lesser degree.



**Figure 4-85: Inorganic element concentrations measured for smoke particles collected with personal cascade impactors during overhaul of the engine compartment fire.**



### Effluent Gas Composition – Area Stands

Average airborne benzene, styrene, formaldehyde, and PAHs concentrations in the vicinity of the front of the car were determined using the collection tubes on area sampling stands. One stand sampled throughout the test and the other stand sampled during the overhaul operation period. Results for the two stands are summarized in Table 4-49. Similar to the passenger compartment fire, the sole detected airborne PAH, naphthalene, was found to be at lower concentrations during overhaul than the previous test periods.

**Table 4-49: Gas concentrations collected with area sampling stands for the engine compartment fire.**

| Species                | Detection Limit (µg) | Sampling Stand: total fire |                            | Sampling Stand: overhaul |                            |
|------------------------|----------------------|----------------------------|----------------------------|--------------------------|----------------------------|
|                        |                      | Mass (µg)                  | Concentration              | Mass (µg)                | Concentration              |
| Benzene                | 1.1                  | 1.5                        | 0.029 ppm                  | < 1.1                    | < 0.065 ppm                |
| Styrene                | 1.3                  | < 1.3                      | < 0.018 ppm                | < 1.3                    | < 0.056 ppm                |
| Formaldehyde           | 0.1                  | 0.39                       | 0.015 ppm                  | < 0.1                    | < 0.012 ppm                |
| Acenaphthylene         | < 0.1                | < 0.1                      | < 0.0013 mg/m <sup>3</sup> | < 0.1                    | < 0.0039 mg/m <sup>3</sup> |
| Acenaphthene           | < 0.1                | < 0.1                      | < 0.0013 mg/m <sup>3</sup> | < 0.1                    | < 0.0039 mg/m <sup>3</sup> |
| Anthracene             | < 0.1                | < 0.1                      | < 0.0013 mg/m <sup>3</sup> | < 0.1                    | < 0.0039 mg/m <sup>3</sup> |
| Benzo(a)anthracene     | < 0.1                | < 0.1                      | < 0.0013 mg/m <sup>3</sup> | < 0.1                    | < 0.0039 mg/m <sup>3</sup> |
| Benzo (a)pyrene        | < 0.1                | < 0.1                      | < 0.0013 mg/m <sup>3</sup> | < 0.1                    | < 0.0039 mg/m <sup>3</sup> |
| Benzo(b)fluoranthene   | < 0.1                | < 0.1                      | < 0.0013 mg/m <sup>3</sup> | < 0.1                    | < 0.0039 mg/m <sup>3</sup> |
| Benzo(k)fluoranthene   | < 0.1                | < 0.1                      | < 0.0013 mg/m <sup>3</sup> | < 0.1                    | < 0.0039 mg/m <sup>3</sup> |
| Benzo(ghi)perylene     | < 0.1                | < 0.1                      | < 0.0013 mg/m <sup>3</sup> | < 0.1                    | < 0.0039 mg/m <sup>3</sup> |
| Chrysene               | < 0.1                | < 0.1                      | < 0.0013 mg/m <sup>3</sup> | < 0.1                    | < 0.0039 mg/m <sup>3</sup> |
| Dibenzo(a,h)anthracene | < 0.1                | < 0.1                      | < 0.0013 mg/m <sup>3</sup> | < 0.1                    | < 0.0039 mg/m <sup>3</sup> |
| Fluoranthene           | < 0.1                | < 0.1                      | < 0.0013 mg/m <sup>3</sup> | < 0.1                    | < 0.0039 mg/m <sup>3</sup> |
| Fluorene               | < 0.1                | < 0.1                      | < 0.0013 mg/m <sup>3</sup> | < 0.1                    | < 0.0039 mg/m <sup>3</sup> |
| Indeno(1,2,3-cd)pyrene | < 0.1                | < 0.1                      | < 0.0013 mg/m <sup>3</sup> | < 0.1                    | < 0.0039 mg/m <sup>3</sup> |
| Naphthalene            | < 0.1                | 0.73                       | 0.0094 mg/m <sup>3</sup>   | < 0.1                    | < 0.0039 mg/m <sup>3</sup> |
| Phenanthrene           | < 0.1                | < 0.1                      | < 0.0013 mg/m <sup>3</sup> | < 0.1                    | < 0.0039 mg/m <sup>3</sup> |
| Pyrene                 | < 0.1                | < 0.1                      | < 0.0013 mg/m <sup>3</sup> | < 0.1                    | < 0.0039 mg/m <sup>3</sup> |

## 4.4 SUMMARY

### 4.4.1 Gas Composition – FTIR

Common combustion products such as water vapor and carbon dioxide were observed in every phase of the fire scenarios monitored – fire growth, suppression, and overhaul. Effluent gases other than water and carbon dioxide detected in the nine fire scenarios by OP-FTIR and extractive FTIR are summarized in Table 4-50. Carbon monoxide, methane, and ethylene were observed in every fire scenario. Ammonia and hydrogen chloride was observed in every scenario except the living room; acetylene and methanol and were observed in every scenario but the living room and bedroom. Hydrogen cyanide, a byproduct of incomplete polyurethane foam combustion, was only found in the attic fire scenario, possibly due to the limited ventilation condition posed by the window opening. Other small molecule hydrocarbons were only detected for certain scenarios: butanol was only detected for the automobile fires (possibly resulting from the combustion of the gasoline used to ignite the automobiles); benzene, phenol and formaldehyde were only detected for the limited ventilation living room fire scenario; and difluoroethane was only detected for the wood deck and automobile fires. Also toluene diisocyanate, a precursor for polyurethane synthesis, was only detected within the limited ventilation living room during the fire growth phase; although this may have been an artificial limitation of having not characterized the gases in the living room and bedroom during the fire growth phases.

Concentrations of the detected gases were found to vary from fire to fire depending on the materials involved in the fire, the ventilation conditions, fire stage, and the sampling location. Peak concentrations were always observed during the fire growth phase; however, concentrations were found to decrease typically by a factor of 5 to 10 within 5 minutes of completing suppression. Gas concentrations during overhaul were larger for the scenarios in which the fire was contained (living rooms, bedroom, and kitchen fires) than the freely dissipating “open-air” fires (decks and automobiles). Furthermore OP-FTIR results were lower than extractive FTIR results because of the gases dissipating prior to detection with the OP-FTIR. This was particularly evident for the contained fire scenarios in which the extractive FTIR was sampling from inside the structure whereas the OP-FTIR was positioned to sample outside of the structure.

**Table 4-50: Effluent gases other than water and carbon dioxide detected by OP-FTIR and extractive FTIR.**

| Fire Scenario               | FTIR <sup>[1]</sup> | Gases Detected |         |          |           |          |         |         |        |              |         |                      |     |     |                |
|-----------------------------|---------------------|----------------|---------|----------|-----------|----------|---------|---------|--------|--------------|---------|----------------------|-----|-----|----------------|
|                             |                     | CO             | Methane | Ethylene | Acetylene | Methanol | Butanol | Benzene | Phenol | Formaldehyde | Ammonia | Toluene Diisocyanate | HCl | HCN | Difluoroethane |
| Living room                 | OP                  | X              | X       | X        | --        | --       | --      | --      | --     | --           | --      | --                   | --  | --  | --             |
|                             | ext                 | X              | X       | X        | --        | --       | --      | --      | --     | --           | --      | --                   | --  | --  | --             |
| Ltd ventilation living room | OP                  | X              | X       | X        | X         | X        | --      | --      | X      | --           | X       | --                   | X   | --  | --             |
|                             | ext                 | X              | X       | X        | X         | X        | --      | X       | X      | X            | X       | X <sup>[4]</sup>     | --  | --  | --             |
| Bedroom                     | OP                  | X              | X       | X        | --        | --       | --      | --      | --     | --           | X       | --                   | X   | --  | --             |
|                             | ext                 | X              | X       | X        | --        | --       | --      | --      | --     | --           | X       | --                   | --  | --  | --             |
| Kitchen                     | OP                  | na             | na      | na       | na        | na       | na      | na      | na     | na           | na      | na                   | na  | na  | na             |
|                             | ext                 | X              | X       | X        | X         | X        | --      | --      | --     | --           | X       | --                   | X   | --  | --             |
| Attic                       | OP                  | X              | --      | X        | X         | X        | --      | --      | --     | --           | X       | --                   | X   | X   | --             |
|                             | ext                 | X              | X       | X        | X         | X        | --      | --      | --     | --           | X       | --                   | X   | --  | --             |
| Wood deck                   | OP                  | X              | --      | X        | X         | X        | --      | --      | --     | --           | X       | --                   | X   | --  | X              |
|                             | ext                 | X              | X       | X        | X         | X        | --      | --      | --     | --           | X       | --                   | X   | --  | X              |
| Composite deck              | OP                  | X              | X       | X        | X         | X        | --      | --      | --     | --           | X       | --                   | X   | --  | --             |
|                             | ext                 | X              | X       | X        | X         | X        | --      | --      | --     | --           | X       | --                   | X   | --  | --             |
| Passenger compartment       | OP                  | X              | X       | X        | X         | X        | X       | --      | --     | --           | X       | --                   | X   | --  | X              |
|                             | ext                 | X              | X       | X        | X         | X        | --      | --      | --     | --           | X       | --                   | X   | --  | X              |
| Engine compartment          | OP                  | X              | X       | X        | X         | X        | X       | --      | --     | --           | X       | --                   | X   | --  | X              |
|                             | ext                 | X              | X       | X        | X         | X        | --      | --      | --     | --           | X       | --                   | X   | --  | X              |
| % of Scenarios              |                     | 100            | 100     | 100      | 78        | 78       | 22      | 11      | 11     | 11           | 89      | 11                   | 89  | 11  | 33             |

Notes: <sup>[1]</sup> FTIR type: OP = OP-FTIR, ext = Extractive FTIR

<sup>[2]</sup> "--" represents Not Detected

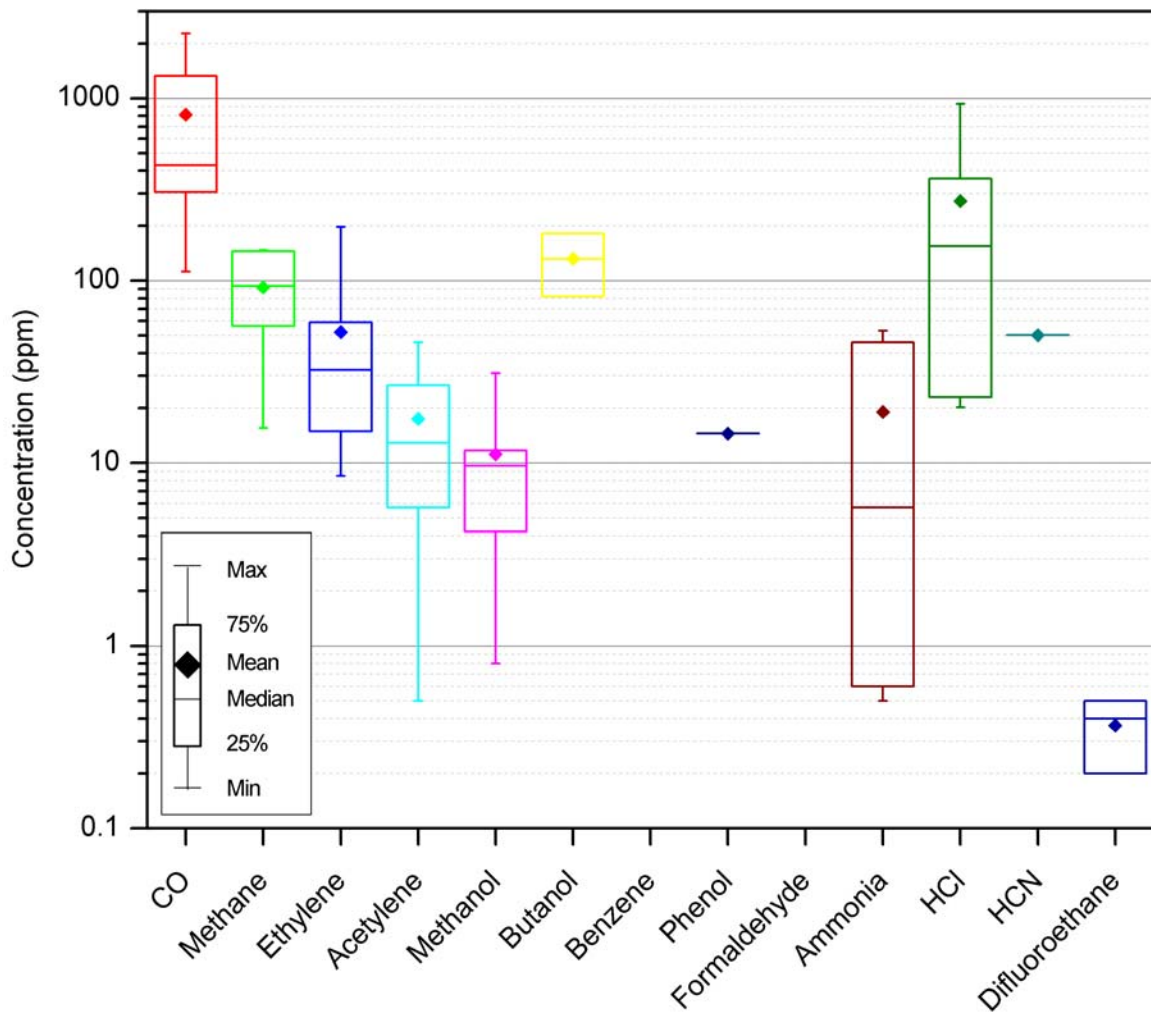
<sup>[3]</sup> "na" represents Not Available

<sup>[4]</sup> Not observed during overhaul

Descriptive statistics (minimum, maximum, 1<sup>st</sup> and 3<sup>rd</sup> quartile, median and mean values) of peak concentrations for the OP-FTIR detected gases are captured in Table 4-51 and plotted in Figure 4-86; descriptive statistics for the total gas exposures, fire ignition through test termination, are captured in Table 4-52 and plotted in Figure 4-87. Likewise descriptive statistics (minimum, maximum, 1<sup>st</sup> and 3<sup>rd</sup> quartile, median and mean values) of peak concentrations of gases detected during overhaul with the extractive FTIR are captured in Table 4-53 and plotted in Figure 4-88 and for the total gas exposures in Table 4-54 and plotted in Figure 4-89.

**Table 4-51: Descriptive statistics for peak gas concentrations measured with OP-FTIR for the large-scale fires.**

| Gas            | Number of samples | Peak Concentration (ppm) |      |        |       |         |       |
|----------------|-------------------|--------------------------|------|--------|-------|---------|-------|
|                |                   | Minimum                  | Q1   | Median | Q3    | Maximum | Mean  |
| CO             | 8                 | 112                      | 300  | 430    | 1510  | 2277    | 814   |
| Methane        | 6                 | 15.5                     | 46.2 | 93.5   | 145.1 | 146.7   | 91.7  |
| Ethylene       | 8                 | 8.5                      | 13.7 | 32.4   | 67.2  | 196.9   | 52.3  |
| Acetylene      | 6                 | 0.5                      | 4.4  | 12.85  | 31.52 | 46      | 17.43 |
| Methanol       | 6                 | 0.8                      | 3.35 | 9.65   | 16.52 | 31      | 11.17 |
| Butanol        | 2                 | 81.8                     | --   | 131.7  | --    | 181.6   | 131.7 |
| Phenol         | 1                 | 14.5                     | --   | 14.5   | --    | 14.5    | 14.5  |
| Ammonia        | 7                 | 0.5                      | 0.6  | 5.7    | 46    | 53      | 19.06 |
| HCl            | 7                 | 20                       | 23   | 155    | 363   | 933     | 274   |
| HCN            | 1                 | 50.1                     | --   | 50.1   | --    | 50.1    | 50.1  |
| Difluoroethane | 3                 | 0.2                      | 0.2  | 0.4    | 0.5   | 0.5     | 0.367 |



**Figure 4-86: Peak gas concentrations measured with OP-FTIR for the large-scale fires.**

Table 4-52: Descriptive statistics for total gas exposure measured with OP-FTIR for the large-scale fires.

| Gas            | Number of samples | Total Exposure (ppm-minute) |       |        |       |         |       |
|----------------|-------------------|-----------------------------|-------|--------|-------|---------|-------|
|                |                   | Minimum                     | Q1    | Median | Q3    | Maximum | Mean  |
| CO             | 8                 | 8                           | 482   | 1549   | 2727  | 9672    | 17708 |
| Methane        | 6                 | 6                           | 45    | 123    | 252   | 804     | 915   |
| Ethylene       | 8                 | 8                           | 7     | 49     | 87    | 347     | 1288  |
| Acetylene      | 6                 | 6                           | 3.3   | 15.3   | 63.2  | 250.8   | 410.2 |
| Methanol       | 6                 | 6                           | 7.2   | 15.5   | 29.5  | 87.8    | 206.6 |
| Butanol        | 2                 | 2                           | 19    | --     | 270   | --      | 521   |
| Phenol         | 1                 | 1                           | 98.9  | --     | 98.9  | --      | 98.9  |
| Ammonia        | 7                 | 7                           | 1     | 1.2    | 35.6  | 85.2    | 143.9 |
| HCl            | 7                 | 7                           | 91    | 264    | 437   | 930     | 3877  |
| HCN            | 1                 | 1                           | 328.6 | --     | 328.6 | --      | 328.6 |
| Difluoroethane | 3                 | 3                           | 0.2   | 0.2    | 0.5   | 6.9     | 6.9   |

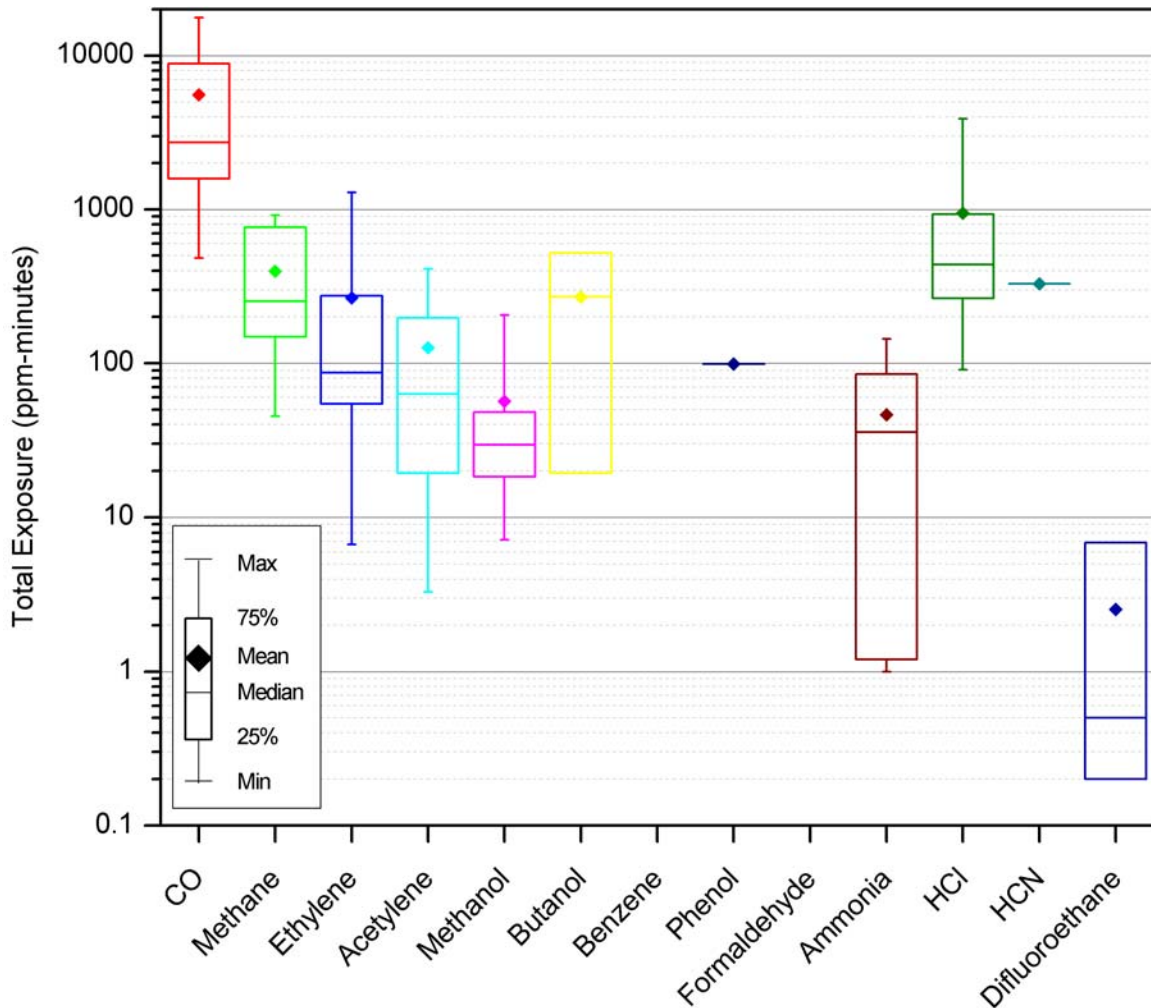
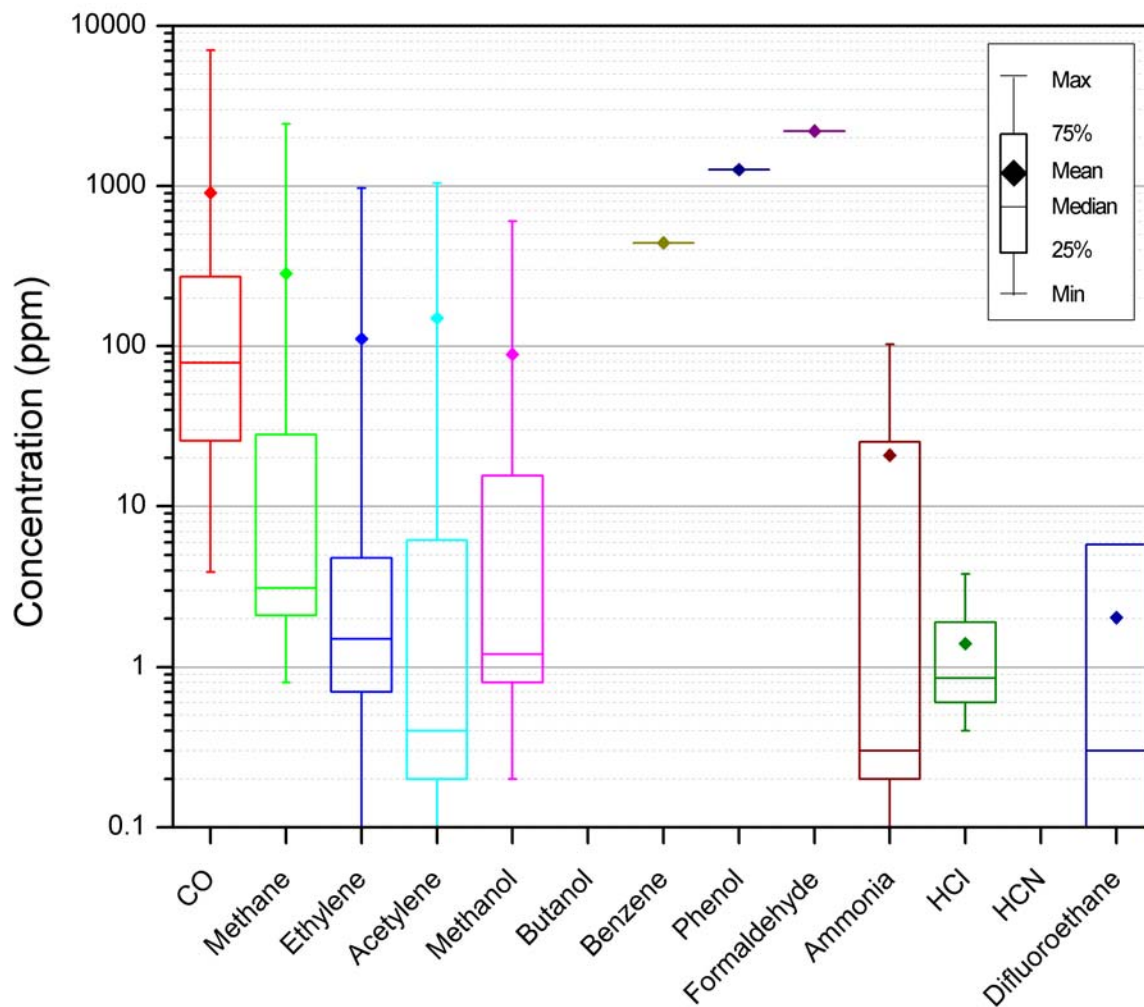


Figure 4-87: Total gas exposure measured with OP-FTIR for the large-scale fires.

**Table 4-53: Descriptive statistics for peak gas concentrations measured with extractive FTIR during overhaul of the large-scale fires.**

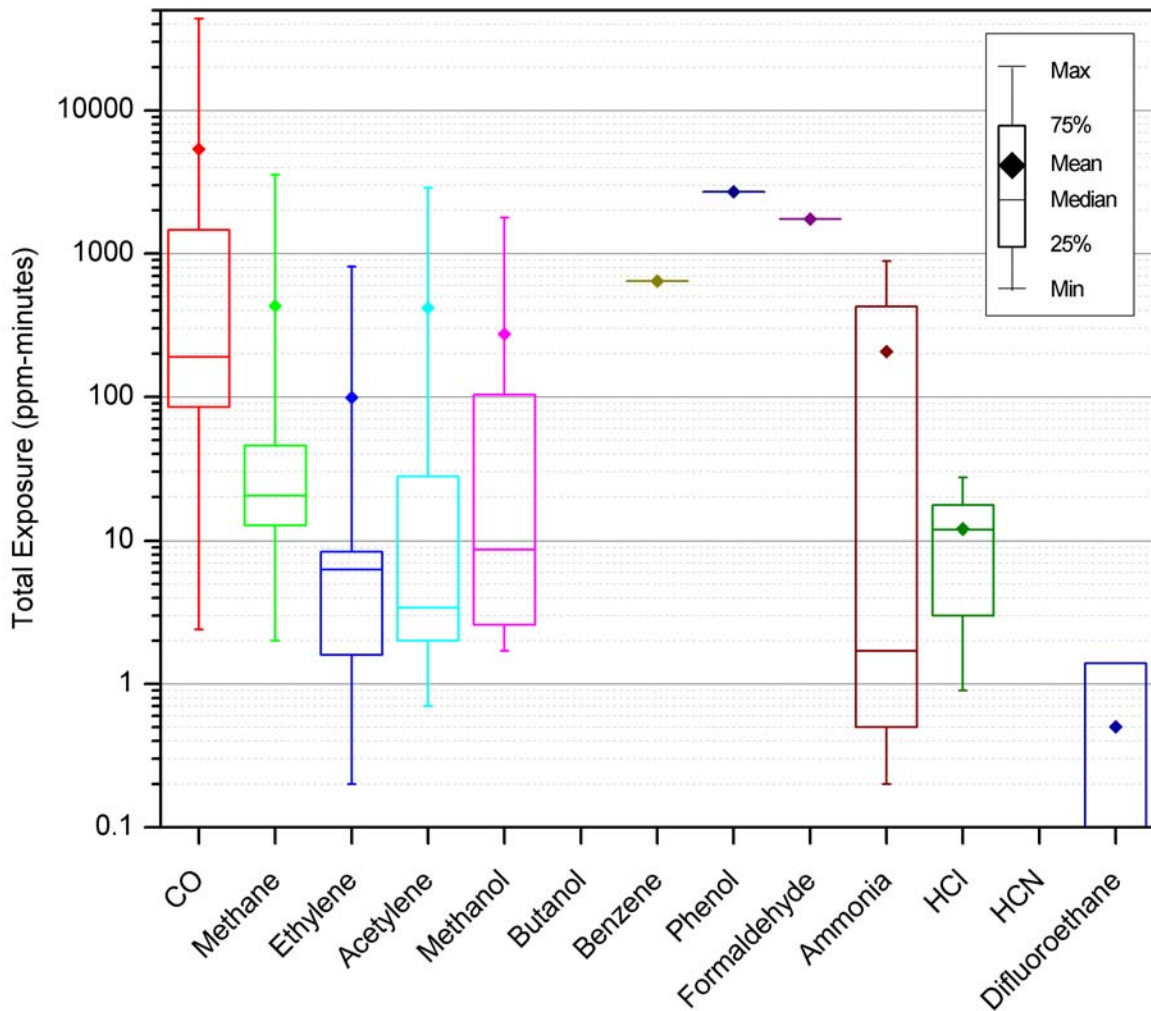
| Gas            | Number of samples | Peak Concentration (ppm) |      |        |       |         | Mean  |
|----------------|-------------------|--------------------------|------|--------|-------|---------|-------|
|                |                   | Minimum                  | Q1   | Median | Q3    | Maximum |       |
| CO             | 9                 | 4                        | 25   | 79     | 426   | 7037    | 906   |
| Methane        | 9                 | 1                        | 2    | 3      | 45    | 2438    | 284   |
| Ethylene       | 9                 | 0                        | 1    | 2      | 12    | 970     | 111   |
| Acetylene      | 7                 | 0                        | 0    | 0      | 6     | 1041    | 150   |
| Methanol       | 7                 | 0.2                      | 0.8  | 1.2    | 15.5  | 602     | 88.9  |
| Benzene        | 1                 | 440.9                    | --   | 440.9  | --    | 440.9   | 440.9 |
| Phenol         | 1                 | 1263                     | --   | 1263   | --    | 1263    | 1263  |
| Formaldehyde   | 1                 | 2202                     | --   | 2202   | --    | 2202    | 2202  |
| Ammonia        | 8                 | 0                        | 0.1  | 0.3    | 23.2  | 102.6   | 18.2  |
| HCl            | 6                 | 0.4                      | 0.55 | 0.85   | 2.375 | 3.8     | 1.4   |
| Difluoroethane | 3                 | 0                        | 0    | 0.3    | 5.8   | 5.8     | 2.03  |



**Figure 4-88: Peak gas concentrations measured with extractive FTIR during overhaul of the large-scale fires.**

**Table 4-54: Descriptive statistics for total gas exposure measured with extractive FTIR during overhaul of the large-scale fires.**

| Gas            | Number of samples | Total Exposure (ppm-minute) |      |        |       |         |       |
|----------------|-------------------|-----------------------------|------|--------|-------|---------|-------|
|                |                   | Minimum                     | Q1   | Median | Q3    | Maximum | Mean  |
| CO             | 9                 | 2                           | 81   | 191    | 1725  | 43748   | 5367  |
| Methane        | 9                 | 2                           | 10   | 21     | 118   | 3559    | 432   |
| Ethylene       | 9                 | 0.2                         | 1.3  | 6.3    | 28.4  | 814.8   | 99    |
| Acetylene      | 7                 | 1                           | 2    | 3      | 28    | 2890    | 419   |
| Methanol       | 7                 | 2                           | 3    | 9      | 104   | 1784    | 275   |
| Benzene        | 1                 | 644.6                       | --   | 644.6  | --    | 644.6   | 644.6 |
| Phenol         | 1                 | 2706                        | --   | 2706   | --    | 2706    | 2706  |
| Formaldehyde   | 1                 | 1747                        | --   | 1747   | --    | 1747    | 1747  |
| Ammonia        | 8                 | 0                           | 0    | 1      | 353   | 886     | 181   |
| HCl            | 6                 | 0.9                         | 2.48 | 11.8   | 20.03 | 27.3    | 12.07 |
| Difluoroethane | 3                 | 0                           | 0    | 0.1    | 1.4   | 1.4     | 0.5   |



**Figure 4-89: Total gas exposure measured with extractive FTIR during overhaul of the large-scale fires.**

Comparison of the gas concentrations to recommended exposure limits, Table 4-55, indicate that multiple gases exceeded IDLH, short-term exposure limits (STEL), and eight hour time weighted average (TWA) exposures at the conducted fire tests. NIOSH IDLH limits were exceeded outside of the fire structure (OP-FTIR) by carbon monoxide at the bedroom and attic fires and by hydrogen cyanide at the attic fire. Carbon monoxide and formaldehyde were also found to exceed the IDLH limits inside of the limited ventilation living room (extractive FTIR) during the fire growth stage as well as overhaul.

STEL were exceeded outside of the attic test structure (OP-FTIR) by carbon monoxide at the limited ventilation living room and attic fires and automobile engine compartment fires. Hydrogen chloride exceeded STEL outside of the limited ventilation living room and attic fires, wood and composite deck structure fires, and the automobile passenger and engine compartment fires. Hydrogen cyanide STEL was only exceeded outside of the attic structure. Gas concentrations exceeding the STEL inside of a structure (extractive FTIR) were only observed for the limited ventilation living room fire. Carbon monoxide, methanol, benzene, and formaldehyde STEL were exceeded during both the fire growth phase as well as overhaul.

Eight hour time weighted average (TWA) exposures were calculated for each fire exposure such that there was no gas exposure beyond the measured time period for the balance of the eight hour TWA period. Calculated TWA exposures measured outside of a structure (OP-FTIR) only exceeded TWA limits at the attic fire for carbon monoxide and hydrogen cyanide. Carbon monoxide, benzene, and formaldehyde TWA limits were exceeded inside of the limited ventilation living room fire during both the fire growth phase as well as overhaul.



**Table 4-55: Large-scale fire scenarios in which FTIR measured gas concentrations exceeded various recommended exposure limits.**

| Gas                  | NIOSH IDLH <sup>[1]</sup> (ppm) | Fires Exceeding IDLH   | NIOSH STEL (ppm)   | Fires Exceeding STEL   | TWA <sup>[2]</sup> (ppm) | Fires Exceeding TWA                                   |
|----------------------|---------------------------------|--|--------------------|--|--------------------------|---|
| CO                   | 1,200                           | OP: Bedroom, Attic<br>ex: Ltd vent. living room <sup>[6]</sup> | 200 <sup>[3]</sup> | OP: Attic, Engine compartment, Ltd vent. living room<br>ex: Ltd vent. living room <sup>[6]</sup> | 35                       | OP: Attic<br>ex: Ltd vent. living room <sup>[6]</sup> |
| Methane              | na                              | --   | na                 | --   | 200 <sup>[5]</sup>       | none  |
| Ethylene             | na                              | --   | na                 | --   | 1000 <sup>[5]</sup>      | none  |
| Acetylene            | na                              | --   | 2500               | none   | na                       | --  |
| Methanol             | 6000                            | none   | 250                | ex: Ltd vent. living room <sup>[6]</sup>   | na                       | --  |
| Butanol              | na                              | --   | na                 | --   | na                       | --  |
| Benzene              | 500                             | none   | 1                  | ex: Ltd vent. living room <sup>[6]</sup>   | 0.1                      | ex: Ltd vent. living room <sup>[6]</sup>              |
| Phenol               | na                              | --   | na                 | --   | na                       | --  |
| Formaldehyde         | 20                              | ex: Ltd vent. living room <sup>[6]</sup>                       | 0.1                | ex: Ltd vent. living room <sup>[6]</sup>   | 0.016                    | ex: Ltd vent. living room <sup>[6]</sup>              |
| Ammonia              | 300                             | none   | 35                 | none   | 25                       | none  |
| Toluene diisocyanate | na                              | --   | na                 | --   | na                       | --  |
| HCl                  | na                              | --   | 5                  | OP: Ltd vent. living room, Attic, Wood & Composite decks, Passenger & Engine compartments        | na                       | --  |
| HCN                  | 50                              | OP: Attic  | 4.7                | OP: Attic  | 10 <sup>[4]</sup>        | OP: Attic   |
| Difluoroethane       | na                              | --   | na                 | --   | na                       | --  |

Notes: <sup>[1]</sup> na stands for not available

<sup>[2]</sup> Where possible NIOSH limits are used as they are more conservative than OSHA limits

<sup>[3]</sup> 10 minute exposure limits

<sup>[4]</sup> OSHA limit

<sup>[5]</sup> ACGIH TLV limit

<sup>[6]</sup> Exceeded during fire growth and overhaul phases

#### 4.4.2 Gas Composition – Area Stands

Gas and airborne vapor concentrations measured using the area stands are summarized in Table 4-56. Typically greater concentrations were observed for the contained fires (living rooms, bedroom, kitchen) than the freely dissipating “open-air” deck and automobile fire scenarios.

Comparison of 15 minute short term exposures and eight-hour time weighted average exposures calculated from the area stand measured concentrations to NIOSH short-term exposure limits (STEL) and eight hour time weighted average (TWA), Table 4-57, indicates that formaldehyde exposure limits were exceeded. Formaldehyde, an IARC Group 1 definite human carcinogen, exceeded the STEL limit during overhaul of the bedroom, kitchen, and living room and during

the fire growth stage of the limited ventilation living room; it was also theoretically possible that the STEL limit was exceeded during the overhaul of the attic, wood deck and composite deck fires. The amounts of formaldehyde to which the firefighters were potentially exposed to during the 30 or so minutes of overhaul for bedroom, kitchen, living room and limited ventilation living room fires was sufficient to exceed the recommended eight hour TWA. It is also possible that concentrations of benzene, another IARC Group 1 definite human carcinogen, may have exceeded STEL and TWA limits during the fire growth stage of the limited ventilation living room.

Although airborne mercury was detected, possibly originating from combustion of compact fluorescent light bulbs used in the room fire scenarios, the measured concentrations were less than recommended STEL and eight hour TWA exposure limits. Other gases and airborne vapors of concern, styrene, hydrogen cyanide, and PAHs were likewise detected but at levels less than recommended exposure limits.

**Table 4-56: Gas and airborne vapor concentrations measured with area stands for the large-scale fires.**

| Scenario                        | Time Period             | Gas Concentration (ppm) <sup>[1]</sup> |         |              |       | Airborne Concentration (mg/m <sup>3</sup> ) <sup>[2]</sup> |        |         |
|---------------------------------|-------------------------|--|---------|--------------|-------|--|--------|---------|
|                                 |                         | Benzene                                | Styrene | Formaldehyde | HCN   | PAHs   |        | Mercury |
| Living room                     | overhaul                | <0.055                                 | 0.27    | 0.38         | na    | na   |        | na      |
| Limited ventilation living room | FG + 4 minutes overhaul | 1.4                                    | 0.27    | 1.7          | 0.77  | Acenaphthylene   | 0.057  | 0.0031  |
|                                 |                         |  |         |              |       | Acenaphthene   | 0.005  |         |
|                                 |                         |  |         |              |       | Anthracene   | 0.0045 |         |
|                                 |                         |  |         |              |       | Fluorene   | 0.017  |         |
|                                 |                         |  |         |              |       | Naphthalene  | 0.48   |         |
|                                 |                         |  |         |              |       | Phenanthrene   | 0.06   |         |
|                                 |                         |  |         |              |       | Others   | nd     |         |
|                                 | overhaul                | 0.33                                   | 0.23    | 0.79         | <0.13 | Acenaphthylene   | 0.054  | 0.0054  |
|                                 |                         |  |         |              |       | Acenaphthene   | 0.0065 |         |
|                                 |                         |  |         |              |       | Anthracene   | 0.0061 |         |
|                                 |                         |  |         |              |       | Fluoranthene   | 0.0047 |         |
|                                 |                         |  |         |              |       | Fluorene   | 0.011  |         |
|                                 |                         |  |         |              |       | Naphthalene  | 0.22   |         |
|                                 |                         |  |         |              |       | Phenanthrene   | 0.03   |         |
|                                 |                         |  |         |              |       | Pyrene   | 0.0078 |         |
|                                 |                         |  |         |              |       | Others   | nd     |         |
| Bedroom                         | overhaul                | 0.12                                   | 0.26    | 0.28         | na    | na   |        | na      |
| Kitchen                         | overhaul                | 0.12                                   | 0.26    | 0.28         | na    | na   |        | 0.002   |
| Attic                           | overhaul                | 0.12                                   | <0.045  | 0.2          | na    | na   |        | 0.0014  |
|                                 | total test              | 0.092                                  | 0.034   | 0.19         | na    | na   |        | 0.00025 |
| Wood deck                       | overhaul                | <0.051                                 | <0.046  | 0.082        | na    | na   |        | na      |
| Composite deck                  | overhaul                | 0.063                                  | <0.048  | 0.13         | na    | na   |        | na      |
| Passenger compartment           | overhaul                | <0.065                                 | <0.06   | 0.024        | na    | Naphthalene  | 0.014  | na      |
|                                 |                         |  |         |              |       | Others   | nd     |         |
|                                 | total test              | <0.027                                 | <0.026  | 0.0068       | na    | Naphthalene  | 0.0038 | na      |
|                                 |                         |  |         |              |       | Others   | nd     |         |
| Engine compartment              | overhaul                | <0.065                                 | <0.056  | <0.012       | na    | Not detected   |        | na      |
|                                 | total test              | 0.029                                  | <0.018  | 0.015        | na    | Naphthalene  | 0.0094 | na      |
|                                 |                         |  |         |              |       | Others   | nd     |         |

Notes: <sup>[1]</sup> "na" represents not measured  
<sup>[2]</sup> "nd" represents not detected

**Table 4-57: Large-scale fires in which gases and airborne vapors measured with area stands exceeded recommended exposure limits.**

| Gas            | NIOSH STEL <sup>[1]</sup> | Fires Exceeding STEL  | TWA <sup>[2]</sup>     | Fires Exceeding TWA   | Carcinogenic Classification <sup>[3]</sup> |
|----------------|---------------------------|---|------------------------|---|--|
| Benzene        | 1 ppm                     | [5]   | 0.1 ppm                | [5]   | IARC 1, ACGIH A2                           |
| Styrene        | 100 ppm                   | none  | 50 ppm                 | none  |  |
| Formaldehyde   | 0.1 ppm                   | Bedroom, Kitchen, Living room, Ltd vent. living room <sup>[6]</sup> | 0.016 ppm              | Bedroom, Kitchen, Living room, Ltd vent. living room <sup>[7]</sup> | IARC 1                                     |
| HCN            | 4.7 ppm                   | none  | 10 ppm <sup>[4]</sup>  | none  |  |
| Acenaphthylene | na                        | --  | na                     | --  | Not rated                                  |
| Acenaphthene   | na                        | --  | na                     | --  | IARC 3                                     |
| Anthracene     | na                        | --  | 0.2 mg/m <sup>3</sup>  | none  | IARC 3                                     |
| Fluoranthene   | na                        | --  | na                     | --  | IARC 3                                     |
| Fluorene       | na                        | --  | na                     | --  | IARC 3                                     |
| Naphthalene    | 75 mg/m <sup>3</sup>      | none  | 50 mg/m <sup>3</sup>   | none  | ACGIH A4                                   |
| Phenanthrene   | na                        | --  | 0.2 mg/m <sup>3</sup>  | none  | IARC 3                                     |
| Pyrene         | na                        | --  | 0.2 mg/m <sup>3</sup>  | none  | IARC 3                                     |
| Mercury        | na                        | --  | 0.05 mg/m <sup>3</sup> | none  |  |

- Notes: <sup>[1]</sup> na stands for not available  
<sup>[2]</sup> Where possible NIOSH limits are used as they are more conservative than OSHA limits  
<sup>[3]</sup> Definition of carcinogenic classifications –  
 IARC 1: definitely carcinogenic to humans  
 IARC 3: not classifiable as to its carcinogenicity to humans  
 ACGIH A2: suspected human carcinogen  
 ACGIH A4: not classifiable as a human carcinogen 10 minute exposure limits  
<sup>[4]</sup> OSHA limit  
<sup>[5]</sup> It is theoretically possible that the limit was exceeded at the limited ventilation living room fire during the fire growth phase.  
<sup>[6]</sup> Exceeded during fire growth phase of the limited ventilation living room. It is also theoretically possible that the limit was exceeded during the attic fire and deck fires.  
<sup>[7]</sup> Exceeded during fire growth and overhaul phases of the limited ventilation living room fire.

### 4.4.3 Smoke Particles

The average smoke particle size, number density, and size distribution, measured as the fractions of particles within specific size ranges, is presented in Table 4-58 for the overhaul stage of each fire scenario. Additional suppression activity during overhaul was found to further reduce smoke particle size and densities. Average smoke particle size, number density and size distribution for the latter stages of overhaul, after the last bout of suppression activity was conducted, is summarized in Table 4-59.

Particle densities measured during overhaul exceeded the average fire test laboratory background concentration by a factor of approximately 4 in the lowest number density scenario (automobile passenger compartment) and 400 in the highest number density scenario (bedroom). Higher particle numbers were observed for the contained fire scenarios (attic, bedroom, kitchen, living rooms) than the freely dissipating “open-air” fires (decks, automobiles), presumably due to containment within an enclosed space. Despite differences in furnishings and other items (and

their chemical compositions) involved in the fires, the smoke particle size distributions were found to be similar for all seven scenarios with particles less than 1 micron in diameter comprising more than 99% of those measured.

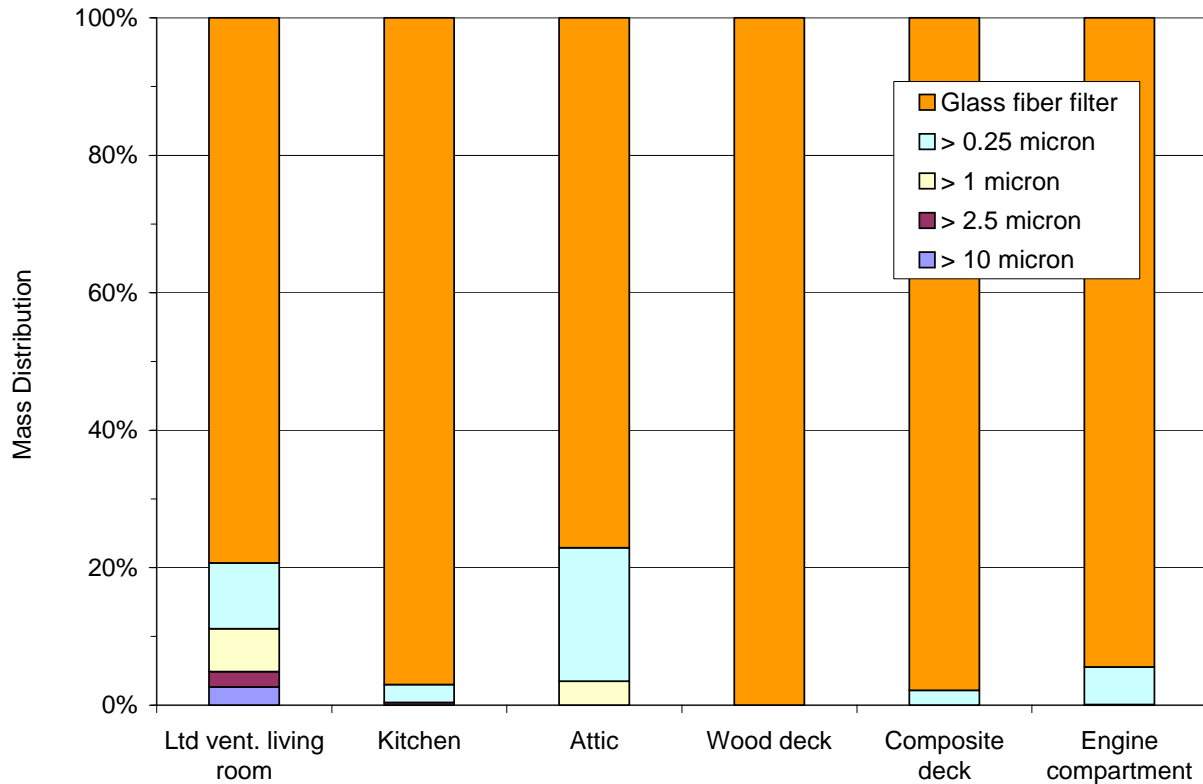
**Table 4-58: Smoke particle number density and size distribution during overhaul of the large-scale fires.**

| Scenario              | Average Particle Size (microns) | Average Number Density (particles/cm <sup>3</sup> ) | Fraction of Particles within Size Ranges (microns) |              |              |              |
|-----------------------|---------------------------------|---|--|--------------|--------------|--------------|
|                       |                                 |   | 0.01 – 0.11  | 0.11 – 1.0   | 1.0 – 2.5    | 2.5 – 10     |
| Living room           | 0.078 ±0.021                    | 5.92 ±2.82 ×10 <sup>5</sup>                         | 0.832 ±0.067                                       | 0.164 ±0.066 | 0.003 ±0.003 | 0.001 ±0.001 |
| Ltd vent. living room | 0.054 ±0.010                    | 1.62 ±4.19 ×10 <sup>6</sup>                         | 0.903 ±0.040                                       | 0.097 ±0.040 | 0.000 ±0.000 | 0.000 ±0.000 |
| Bedroom               | 0.098 ±0.144                    | 2.11 ±3.26 ×10 <sup>6</sup>                         | 0.840 ±0.293                                       | 0.158 ±0.289 | 0.001 ±0.004 | 0.000 ±0.001 |
| Kitchen               | 0.083 ±0.023                    | 6.34 ±8.26 ×10 <sup>4</sup>                         | 0.788 ±0.105                                       | 0.211 ±0.105 | 0.001 ±0.001 | 0.000 ±0.000 |
| Attic                 | 0.088 ±0.018                    | 1.20 ±1.01 ×10 <sup>5</sup>                         | 0.759 ±0.102                                       | 0.241 ±0.102 | 0.000 ±0.000 | 0.000 ±0.000 |
| Wood deck             | 0.085 ±0.017                    | 8.55 ±15.3 ×10 <sup>4</sup>                         | 0.764 ±0.094                                       | 0.236 ±0.094 | 0.000 ±0.000 | 0.000 ±0.000 |
| Composite deck        | 0.100 ±0.035                    | 4.55 ±5.98 ×10 <sup>4</sup>                         | 0.701 ±0.190                                       | 0.298 ±0.190 | 0.000 ±0.000 | 0.000 ±0.000 |
| Passenger compartment | 0.046 ±0.037                    | 1.96 ±0.62 ×10 <sup>4</sup>                         | 0.914 ±0.146                                       | 0.086 ±0.146 | 0.000 ±0.000 | 0.000 ±0.000 |
| Engine compartment    | 0.062 ±0.019                    | 6.73 ±9.86 ×10 <sup>4</sup>                         | 0.878 ±0.077                                       | 0.121 ±0.076 | 0.000 ±0.001 | 0.000 ±0.000 |
| Average               | 0.054 ±0.010                    | 5.26 ±7.90 ×10 <sup>5</sup>                         | 0.820 ±0.072                                       | 0.179 ±0.072 | 0.001 ±0.001 | 0.000 ±0.000 |

**Table 4-59: Smoke particle number density and size distribution for later stages of overhaul of the large-scale fires.**

| Scenario              | Average Particle Size (microns) | Average Number Density (particles/cm <sup>3</sup> ) | Fraction of Particles within Size Ranges (microns) |              |              |              |
|-----------------------|---------------------------------|---|--|--------------|--------------|--------------|
|                       |                                 |   | 0.01 – 0.11  | 0.11 – 1.0   | 1.0 – 2.5    | 2.5 – 10     |
| Living room           | 0.079 ±0.020                    | 1.61 ±0.31 ×10 <sup>4</sup>                         | 0.833 ±0.058                                       | 0.163 ±0.057 | 0.003 ±0.003 | 0.001 ±0.001 |
| Ltd vent. living room | 0.052 ±0.005                    | 1.05 ±0.28 ×10 <sup>4</sup>                         | 0.910 ±0.016                                       | 0.090 ±0.016 | 0.000 ±0.000 | 0.000 ±0.000 |
| Bedroom               | 0.066 ±0.003                    | 7.04 ±1.51 ×10 <sup>4</sup>                         | 0.903 ±0.021                                       | 0.097 ±0.021 | 0.000 ±0.000 | 0.000 ±0.000 |
| Kitchen               | 0.078 ±0.018                    | 4.32 ±2.92 ×10 <sup>4</sup>                         | 0.808 ±0.082                                       | 0.191 ±0.082 | 0.001 ±0.001 | 0.000 ±0.000 |
| Attic                 | 0.077 ±0.009                    | 1.01 ±0.81 ×10 <sup>5</sup>                         | 0.817 ±0.050                                       | 0.183 ±0.050 | 0.000 ±0.000 | 0.000 ±0.000 |
| Wood deck             | 0.075 ±0.005                    | 2.45 ±1.11 ×10 <sup>4</sup>                         | 0.817 ±0.026                                       | 0.183 ±0.026 | 0.000 ±0.000 | 0.000 ±0.000 |
| Composite deck        | 0.076 ±0.008                    | 1.48 ±0.80 ×10 <sup>4</sup>                         | 0.834 ±0.040                                       | 0.166 ±0.040 | 0.000 ±0.000 | 0.000 ±0.000 |
| Passenger compartment | 0.035 ±0.002                    | 2.06 ±0.47 ×10 <sup>4</sup>                         | 0.952 ±0.006                                       | 0.048 ±0.006 | 0.000 ±0.000 | 0.000 ±0.000 |
| Engine compartment    | 0.054 ±0.005                    | 1.59 ±0.36 ×10 <sup>4</sup>                         | 0.914 ±0.012                                       | 0.086 ±0.012 | 0.000 ±0.000 | 0.000 ±0.000 |
| Average               | 0.066 ±0.016                    | 3.53 ±3.11 ×10 <sup>4</sup>                         | 0.865 ±0.054                                       | 0.134 ±0.054 | 0.000 ±0.001 | 0.000 ±0.000 |

Mass distribution analysis of the smoke particles collected with the bench-top cascade impactor during the fire growth phase of the large-scale fires, summarized in Figure 4-90, indicates that the bulk of the airborne particles are less than 1 micron in size. Greater percentages of larger particles were observed for the two ventilation limited scenarios (living room, attic).



**Figure 4-90: Mass distribution of smoke particles collected with the bench-top cascade impactor during the fire growth phase for the large-scale fires.**

#### 4.4.4 Personal Air Sampling – Gas

A pair of outfitted firefighters measured gas concentrations in their personal area using direct reading gas monitors during overhaul of the nine test fire scenarios. During the course of the study, one of the monitoring units was inadvertently deactivated (attic) and one monitoring unit failed in use (composite deck); the carbon monoxide sensor failed in one unit for two fire scenarios (wood deck and passenger compartment).

Concentrations of the gases monitored were found to vary from fire to fire depending on the materials engaged in the fire and the ventilation conditions. For example, greater peak concentrations of incompletely oxidized gases (hydrogen cyanide, ammonia, hydrogen sulfide, and carbon monoxide) were observed for the scenarios in which the fire was contained (living rooms, bedroom, and kitchen fires) than the uncontained “open-air” fires (decks and automobiles); conversely the “open-air” fire scenarios exhibited greater peak concentrations of the fully oxidized gases (sulfur dioxide and nitrogen dioxide). Of the contained fires, the limited ventilation living room fire had the greatest peak concentrations of ammonia, hydrogen sulfide and carbon monoxide. Total gas exposure for all of the gases except nitrogen dioxide (which was comparable) however was considerably greater for the contained fire scenarios than the “open-air” fires. This was due to the room walls restricting gas dissipation to the surrounding areas.

Descriptive statistics (minimum, maximum, 1<sup>st</sup> and 3<sup>rd</sup> quartile, median and mean values) of peak concentrations and total exposures for the six monitored gases are captured in Table 4-60 and Table 4-61 respectively. Nitrogen oxide, hydrogen sulfide, and carbon monoxide were observed at every fire by both monitored responders; hydrogen cyanide, ammonia, and sulfur dioxide were observed at every fire but not always by both monitored responders.

**Table 4-60: Descriptive statistics for peak gas concentrations measured with personal monitors during overhaul of the large-scale fires.**

| Gas              | Number of samples | Peak Concentration (ppm) |       |        |       |         |       |
|------------------|-------------------|--------------------------|-------|--------|-------|---------|-------|
|                  |                   | Minimum                  | Q1    | Median | Q3    | Maximum | Mean  |
| HCN              | 16                | 0                        | 0.1   | 0.45   | 1.675 | 4.6     | 0.988 |
| NH <sub>3</sub>  | 16                | 0                        | 1     | 5.5    | 16.75 | 54      | 12.31 |
| SO <sub>2</sub>  | 16                | 0                        | 0.38  | 1.9    | 8.47  | 22.1    | 4.99  |
| NO <sub>2</sub>  | 16                | 0.3                      | 0.9   | 1.2    | 1.4   | 8.3     | 1.669 |
| H <sub>2</sub> S | 16                | 0.5                      | 1.725 | 4.05   | 8.45  | 13.5    | 4.888 |
| CO               | 14                | 11                       | 67.5  | 118.5  | 288.8 | 1003    | 223.9 |

**Table 4-61: Descriptive statistics for total gas exposure measured with personal monitors during overhaul of the large-scale fires.**

| Gas              | Number of samples | Total Exposure (ppm-minutes) |       |        |       |         |       |
|------------------|-------------------|------------------------------|-------|--------|-------|---------|-------|
|                  |                   | Minimum                      | Q1    | Median | Q3    | Maximum | Mean  |
| HCN              | 16                | 0                            | 0.41  | 2.39   | 8.72  | 23.53   | 5.27  |
| NH <sub>3</sub>  | 16                | 0                            | 3.9   | 20.3   | 158.8 | 364.3   | 86.7  |
| SO <sub>2</sub>  | 16                | 0                            | 0.86  | 4.98   | 24.87 | 70.07   | 16.55 |
| NO <sub>2</sub>  | 16                | 0.455                        | 1.016 | 1.694  | 3.056 | 5.138   | 2.121 |
| H <sub>2</sub> S | 16                | 0.05                         | 4.11  | 21.28  | 29.78 | 53.12   | 20.16 |
| CO               | 14                | 55                           | 119   | 326    | 729   | 2806    | 628   |

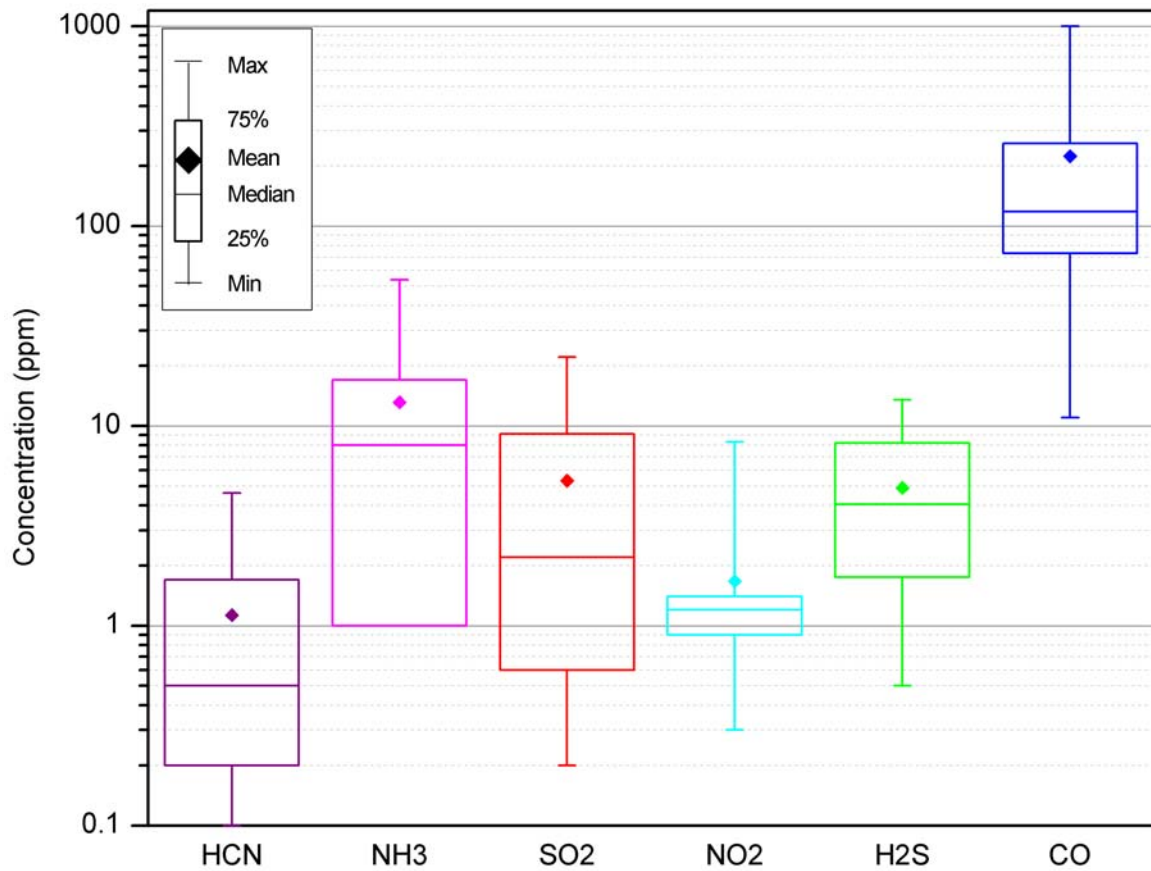
The previous data provides a gross estimate of potential average exposure threat from a given fire. This information is useful for estimating the total potential exposure over the course of time, for instance the total potential exposure over a year could be calculated by multiplying the number of responded to fires by the mean values in Table 4-61.

Because not every gas was found at each fire, descriptive statistics (minimum, maximum, 1<sup>st</sup> and 3<sup>rd</sup> quartile, median and mean values) summarized in Table 4-62 and plotted in Figure 4-91 reflect of the peak gas concentrations for *only* the fires in which they were detected rather than across all monitored fires. Similarly descriptive statistics (minimum, maximum, 1<sup>st</sup> and 3<sup>rd</sup> quartile, median and mean values) summarized in Table 4-62 and plotted in Figure 4-92 reflect of the total gas exposures for *only* the fires in which they were detected rather than across all monitored fires. This information is more useful for estimating the potential exposure threat that firefighters may be exposed to at a given fire.

**Table 4-62: Descriptive statistics for peak gas concentrations measured with personal monitors during overhaul of the large-scale fires.**

| Gas              | Number of samples <sup>[1]</sup> | Peak Concentration (ppm) |       |        |       |         |       |
|------------------|----------------------------------|--------------------------|-------|--------|-------|---------|-------|
|                  |                                  | Minimum                  | Q1    | Median | Q3    | Maximum | Mean  |
| HCN              | 14                               | 0.1                      | 0.175 | 0.5    | 1.775 | 4.6     | 1.129 |
| NH <sub>3</sub>  | 15                               | 1                        | 1     | 8      | 17    | 54      | 13.13 |
| SO <sub>2</sub>  | 15                               | 0.2                      | 0.6   | 2.2    | 9.1   | 22.1    | 5.32  |
| NO <sub>2</sub>  | 16                               | 0.3                      | 0.9   | 1.2    | 1.4   | 8.3     | 1.669 |
| H <sub>2</sub> S | 16                               | 0.5                      | 1.725 | 4.05   | 8.45  | 13.5    | 4.888 |
| CO               | 14                               | 11                       | 67.5  | 118.5  | 288.8 | 1003    | 223.9 |

Note: <sup>[1]</sup> Number of samples is limited to responder recordings in which the particular gas species was observed.



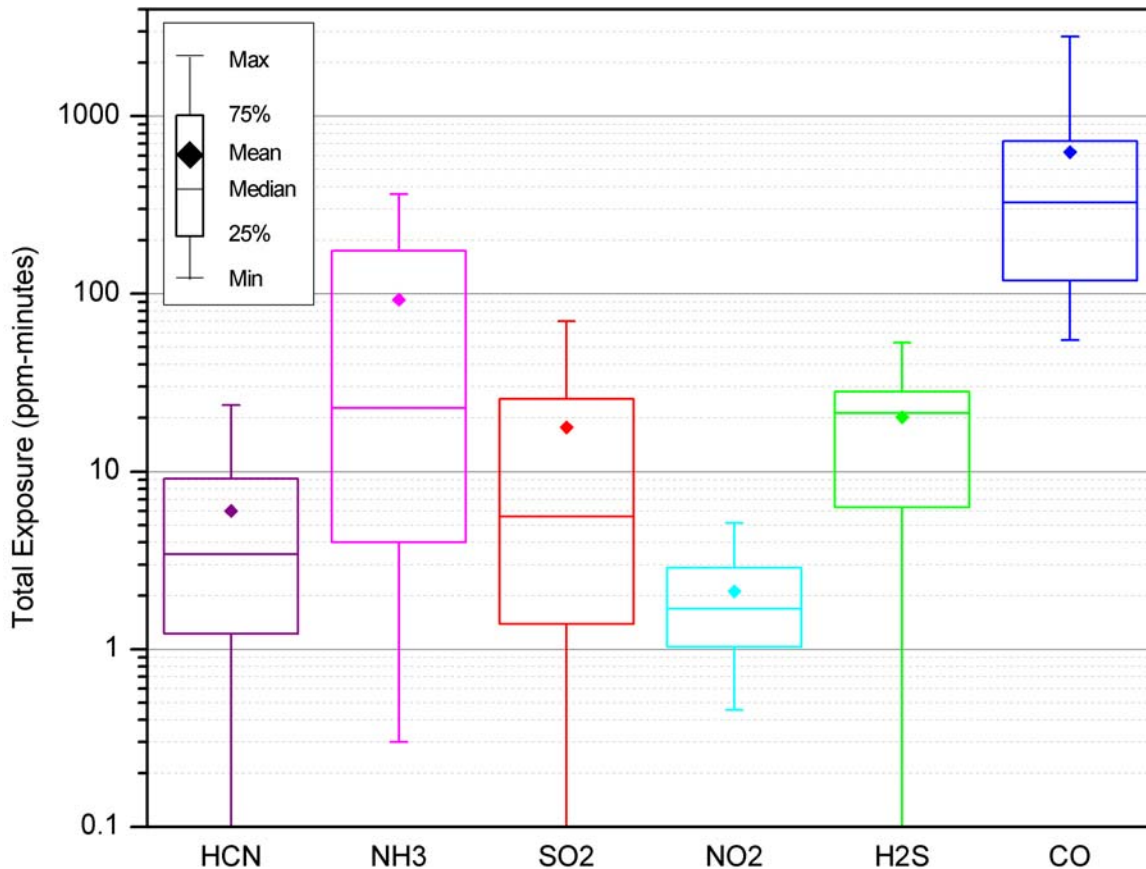
**Figure 4-91: Peak gas concentrations measured with personal monitors during overhaul of the large-scale fires.**



**Table 4-63: Descriptive statistics for total gas exposure measured with personal monitors during overhaul of the large-scale fires.**

| Gas              | Number of samples <sup>[1]</sup> | Total Exposure (ppm-minutes) |       |        |       |         |       |
|------------------|----------------------------------|------------------------------|-------|--------|-------|---------|-------|
|                  |                                  | Minimum                      | Q1    | Median | Q3    | Maximum | Mean  |
| HCN              | 14                               | 0.01                         | 1.11  | 3.42   | 9.52  | 23.53   | 6.02  |
| NH <sub>3</sub>  | 15                               | 0.3                          | 4     | 22.7   | 174   | 364.3   | 92.5  |
| SO <sub>2</sub>  | 15                               | 0.03                         | 1.38  | 5.6    | 25.52 | 70.07   | 17.65 |
| NO <sub>2</sub>  | 16                               | 0.455                        | 1.016 | 1.694  | 3.056 | 5.138   | 2.121 |
| H <sub>2</sub> S | 16                               | 0.05                         | 4.11  | 21.28  | 29.78 | 53.12   | 20.16 |
| CO               | 14                               | 55                           | 119   | 326    | 729   | 2806    | 628   |

Note: <sup>[1]</sup> Number of samples is limited to responder recordings in which the particular gas species was observed.



**Figure 4-92: Total gas exposure measured with personal monitors during overhaul of the large-scale fires.**

Comparison of the recorded gas concentrations to NIOSH and OSHA exposure limits, Table 4-64, indicate that none of the gas concentrations measured in the firefighters’ personal area during overhaul of the nine large-scale test fire scenarios exceeded IDLH limits or short-term exposure limits (STEL). Eight hour time weighted average (TWA) exposures were calculated for each fire exposure such that there was no gas exposure beyond the measured time period for the balance of the eight hour TWA period. None of the gases exceeded TWA limits.

**Table 4-64: Number of large-scale fire scenarios in which gas concentrations measured with personal monitors during overhaul exceeded various recommended exposure limits.**

| Gas              | NIOSH IDLH (ppm) | Fires Exceeding IDLH | NIOSH STEL (ppm)   | Fires Exceeding STEL | TWA <sup>[2]</sup> (ppm) | Fires Exceeding TWA |
|------------------|------------------|----------------------|--------------------|----------------------|--------------------------|---------------------|
| HCN              | 50               | none                 | 4.7                | none                 | 10 <sup>[3]</sup>        | none                |
| NH <sub>3</sub>  | 300              | none                 | 35                 | none                 | 25                       | none                |
| SO <sub>2</sub>  | 100              | none                 | 5                  | none                 | 2                        | none                |
| NO <sub>2</sub>  | 20               | none                 | 1                  | none                 | 5 <sup>[3]</sup>         | none                |
| H <sub>2</sub> S | 100              | none                 | 10 <sup>[1]</sup>  | none                 | 10                       | none                |
| CO               | 1,200            | none                 | 200 <sup>[1]</sup> | none                 | 35                       | none                |

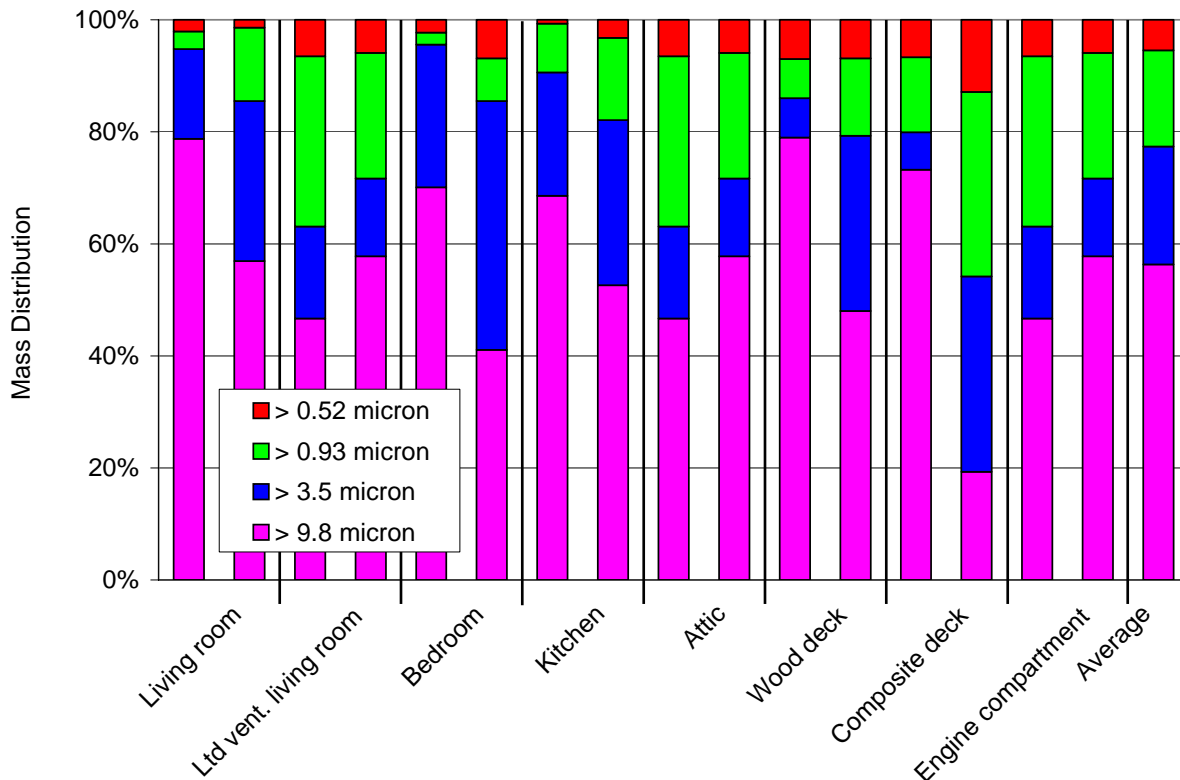
Notes: <sup>[1]</sup> 10 minute exposure limits

<sup>[2]</sup> Where possible NIOSH limits are used as they are more conservative than OSHA limits

<sup>[3]</sup> OSHA limit

#### 4.4.5 Personal Air Sampling – Smoke Particle Size Distribution

A pair of outfitted firefighters collected smoke particles from their personal area using personal cascade impactors during overhaul of eight test fire scenarios (personal impactors were available for use during the passenger compartment fire scenario). Analysis of the smoke particles accumulated on the four cut plates (0.52, 0.93, 3.5, 9.8 micron), Figure 4-93, reveals that the relative mass distributions varied considerably for the different fire tests. Sizable variation was observed for firefighters operating at the same fire (living room, bedroom, decks) can be seen, presumably due to the firefighter’s individual activities on the scene. In contrast to the personal gas monitor results, no clear smoke particle mass distribution trends could be established for ventilation conditions.

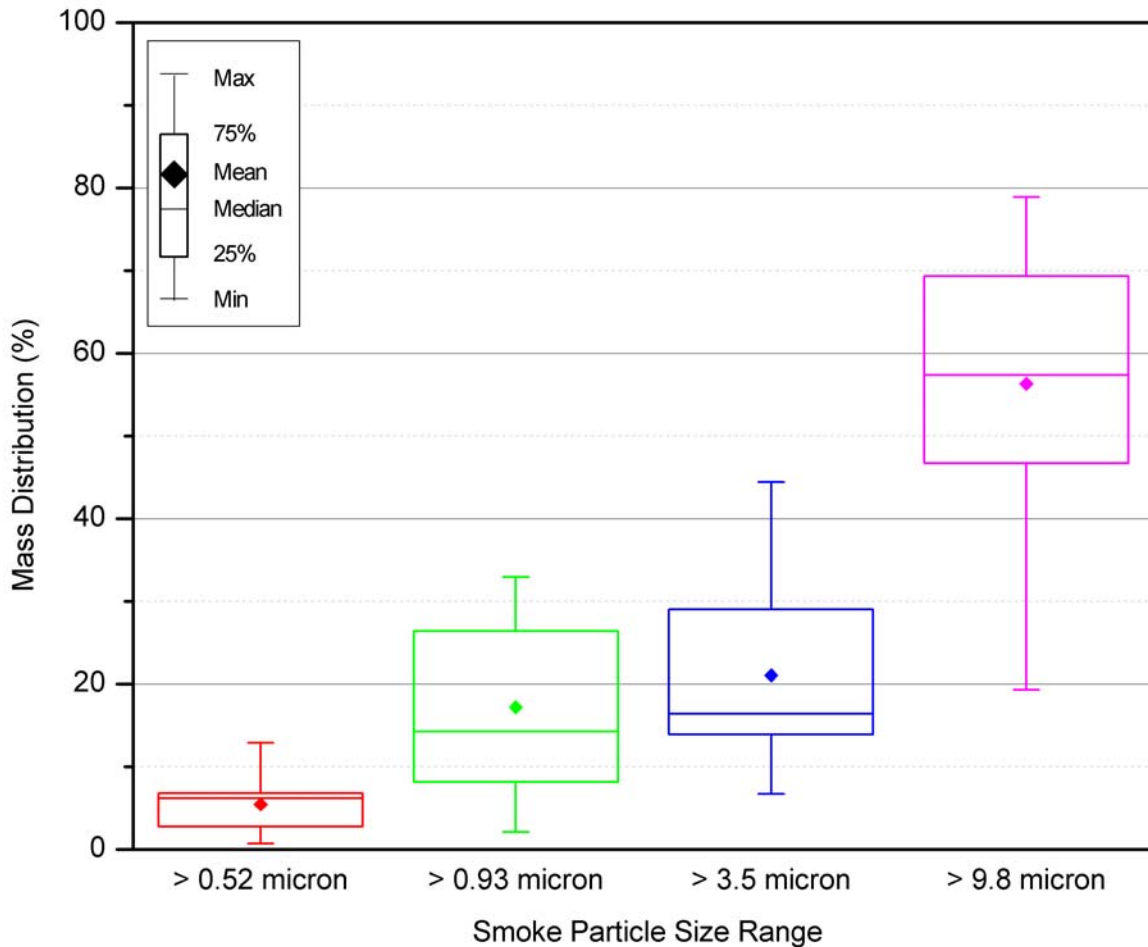


**Figure 4-93: Smoke particle size distribution for personal impactors used in the large-scale fires.**

Descriptive statistics (minimum, maximum, 1<sup>st</sup> and 3<sup>rd</sup> quartile, median and mean values) of the smoke particle mass distributions are captured in Table 4-65 and plotted in Figure 4-94.

**Table 4-65: Descriptive statistics for mass distribution of smoke particles collected with personal impactors during overhaul of the large-scale fires.**

| Particle Size | Number of samples | Mass Distribution (%) |       |        |       |         |       |
|---------------|-------------------|-----------------------|-------|--------|-------|---------|-------|
|               |                   | Minimum               | Q1    | Median | Q3    | Maximum | Mean  |
| > 0.52 micron | 16                | 0.7                   | 2.525 | 6.2    | 6.85  | 12.9    | 5.456 |
| > 0.93 micron | 16                | 2.1                   | 7.88  | 14.25  | 28.4  | 32.9    | 17.18 |
| > 3.5 micron  | 16                | 6.7                   | 13.9  | 16.4   | 29.25 | 44.4    | 21.04 |
| > 9.8 micron  | 16                | 19.3                  | 46.7  | 57.35  | 69.73 | 78.9    | 56.31 |

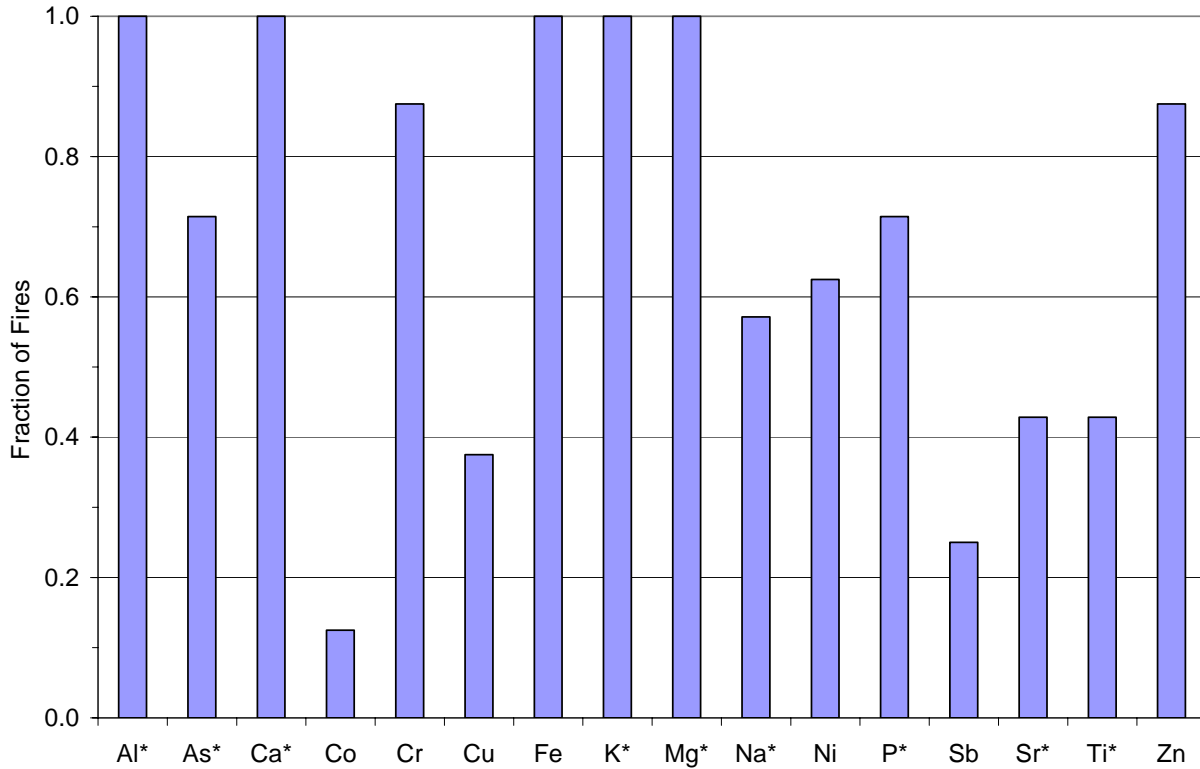


**Figure 4-94: Variation in mass distribution of smoke particles collected with personal impactors during overhaul of the large-scale fires.**

#### 4.4.6 Personal Air Sampling – Smoke Particle Inorganic Content

Smoke particles collected from the firefighters personal area on the four personal cascade impactors cut plates were analyzed for inorganic element content. The numbers of fires in which quantifiable amounts of the various inorganic elements were found in the collected smoke particles are plotted in Figure 4-95 and the specific fires are identified in Table 4-66. Barium, beryllium, cadmium, lead, lithium, molybdenum, selenium, silver, thallium, tin, and vanadium

were not found at quantifiable limits in any of the collected samples. The most frequently found elements (all fires: aluminum, calcium, iron, potassium, and magnesium) correspond to those most prevalent in the earth’s crust<sup>2</sup>.



**Figure 4-95: Frequency of large-scale fires in which inorganic elements were detected in personal impactor collected smoke particles.**

<sup>2</sup> The most common elements present in the earth’s crust are oxygen (46.6%), silicon (27.7%), aluminum (8.1%), iron (5.0%), calcium (3.6%), sodium (2.8%), potassium (2.6%), magnesium (2.1%). Source: “Windows to the Universe”, University Corporation for Atmospheric Research.

**Table 4-66: Large-scale fires in which inorganic elements were detected in personal impactor collected smoke particles.**

| Element     |    | Living room    | Limited ventilation living room | Bedroom | Kitchen | Attic | Wood deck | Composite deck | Engine compartment | % of Fires <sup>[2]</sup> |
|-------------|----|----------------|---------------------------------|---------|---------|-------|-----------|----------------|--------------------|---------------------------|
| Aluminum    | Al | <sup>[1]</sup> | X                               | X       | X       | X     | X         | X              | X                  | 100                       |
| Arsenic     | As | <sup>[1]</sup> | X                               | X       | X       | X     | --        | X              | --                 | 71                        |
| Calcium     | Ca | <sup>[1]</sup> | X                               | X       | X       | X     | X         | X              | X                  | 100                       |
| Cobalt      | Co | --             | --                              | --      | --      | X     | --        | --             | --                 | 13                        |
| Chromium    | Cr | X              | X                               | X       | X       | X     | --        | X              | X                  | 88                        |
| Copper      | Cu | --             | --                              | --      | --      | X     | --        | X              | --                 | 38                        |
| Iron        | Fe | X              | X                               | X       | X       | X     | X         | X              | X                  | 100                       |
| Potassium   | K  | <sup>[1]</sup> | X                               | X       | X       | X     | X         | X              | X                  | 100                       |
| Magnesium   | Mg | <sup>[1]</sup> | X                               | X       | X       | X     | X         | X              | X                  | 100                       |
| Sodium      | Na | <sup>[1]</sup> | X                               | X       | X       | --    | --        | X              | --                 | 57                        |
| Nickel      | Ni | --             | X                               | X       | --      | X     | X         | --             | X                  | 63                        |
| Phosphorous | P  | <sup>[1]</sup> | --                              | X       | X       | X     | --        | X              | X                  | 71                        |
| Antimony    | Sb | --             | X                               | --      | --      | X     | --        | --             | --                 | 25                        |
| Strontium   | Sr | <sup>[1]</sup> | X                               | X       | X       | --    | --        | --             | --                 | 43                        |
| Titanium    | Ti | <sup>[1]</sup> | X                               | X       | X       | X     | --        | --             | --                 | 43                        |
| Zinc        | Zn | X              | --                              | X       | X       | X     | X         | X              | X                  | 88                        |

Notes: <sup>[1]</sup> Samples were not analyzed for these elements.

<sup>[2]</sup> Based on the number of fires from which samples were analyzed

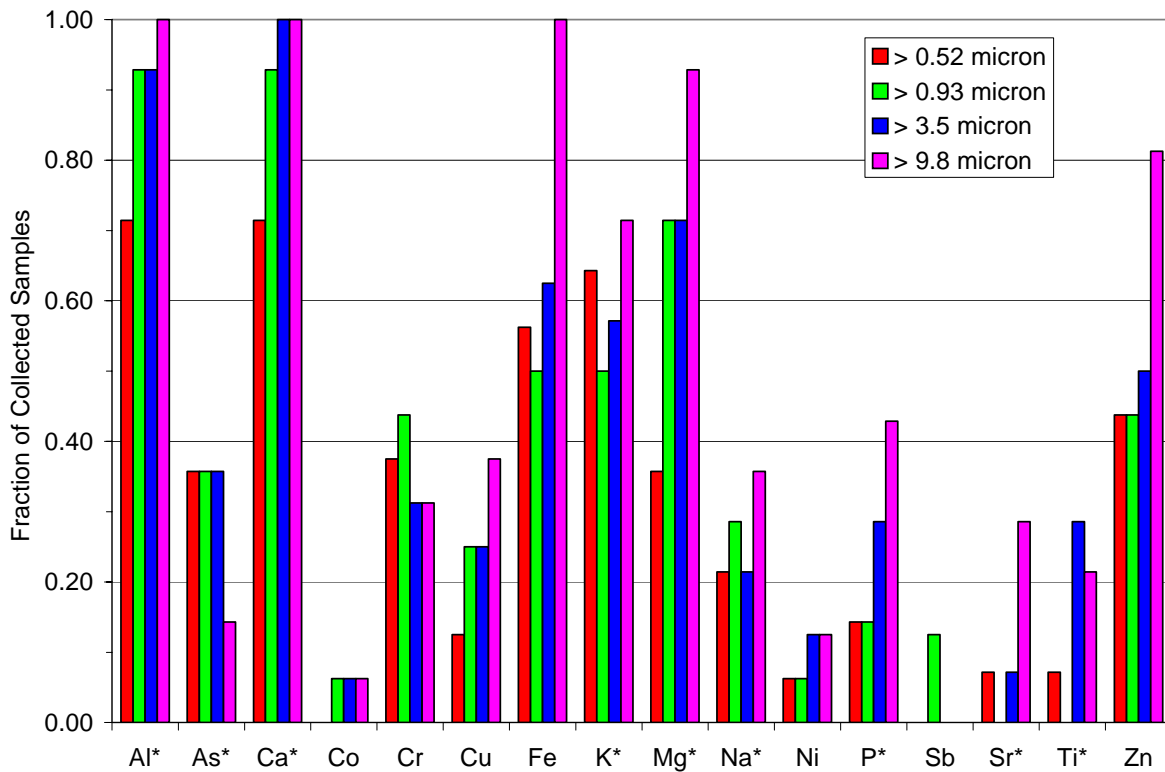
<sup>[3]</sup> "--" represents Not Detected

The smoke particles from the interior fires (living rooms, bedroom, kitchen, attic) had essentially the same assortment of inorganic elements present. Key differences between these fires were the presence of strontium in the scenarios that included televisions (living room, bedroom, kitchen), presence of copper in the attic scenario (presumably from the copper wiring included in the scenario), and the presence of cobalt in the attic scenario (presumably from at least one of the stored items included in the scenario). Antimony, an element used in plastic materials for its synergistic fire retardant effects, was found for the two ventilation limited scenarios (living room, attic) that included numerous items made from plastic components.

The two deck scenarios were virtually the same except for the deck board and siding materials. The composite deck scenario involved wood-plastic composite deck boards and vinyl siding whereas the wood deck scenario used treated pine deck boards and OSB siding. Consequently differences in the inorganic elements found in the resulting smoke particles should be due to the involved deck boards and sidings. Arsenic, copper, and chromium were found for the composite deck scenario. These materials have been incorporated in wood-plastic deck boards to improve mold, fungus, and insect resistance.

Closer examination of the inorganic element content for the smoke particles collected in the four size ranges (0.52 to 0.93, 0.93 to 3.5, 3.5 to 9.8, and greater than 9.8 microns), Figure 4-96, indicates that inorganic elements were generally found in larger smoke particles more often than in the corresponding smaller particle size fractions, for example aluminum and calcium were

found in 100% of the collected samples of smoke particles greater than 9.8 microns but in only 93% of the collected smoke particles between 0.93 and 3.5 microns in size and only 71% of the 0.35 to 0.93 micron particles. Arsenic and chromium were found to differ from this trend such that there does not appear to be a clear particle size influence on the number of fires in which these elements were found.



**Figure 4-96: Frequency of large-scale fire personal impactor collected smoke particle samples in which inorganic elements were detected.**

Descriptive statistics (minimum, maximum, 1<sup>st</sup> and 3<sup>rd</sup> quartile, median and mean values) of the inorganic elemental concentrations measured for the four size ranges (0.52 to 0.93, 0.93 to 3.5, 3.5 to 9.8, and greater than 9.8 microns) are plotted in Figure 4-97 and tabulated in Table 4-67. Measured concentrations for most elements ranged between 0.001 and 0.1 mg/m<sup>3</sup> with the greatest concentrations seen for calcium. It is unclear if there is an overall relationship trend between element concentration and particle size. For instance concentrations of aluminum, calcium, magnesium and zinc clearly increase with smoke particle size whereas arsenic, chromium, iron, and potassium concentrations appear to be independent of particle size.

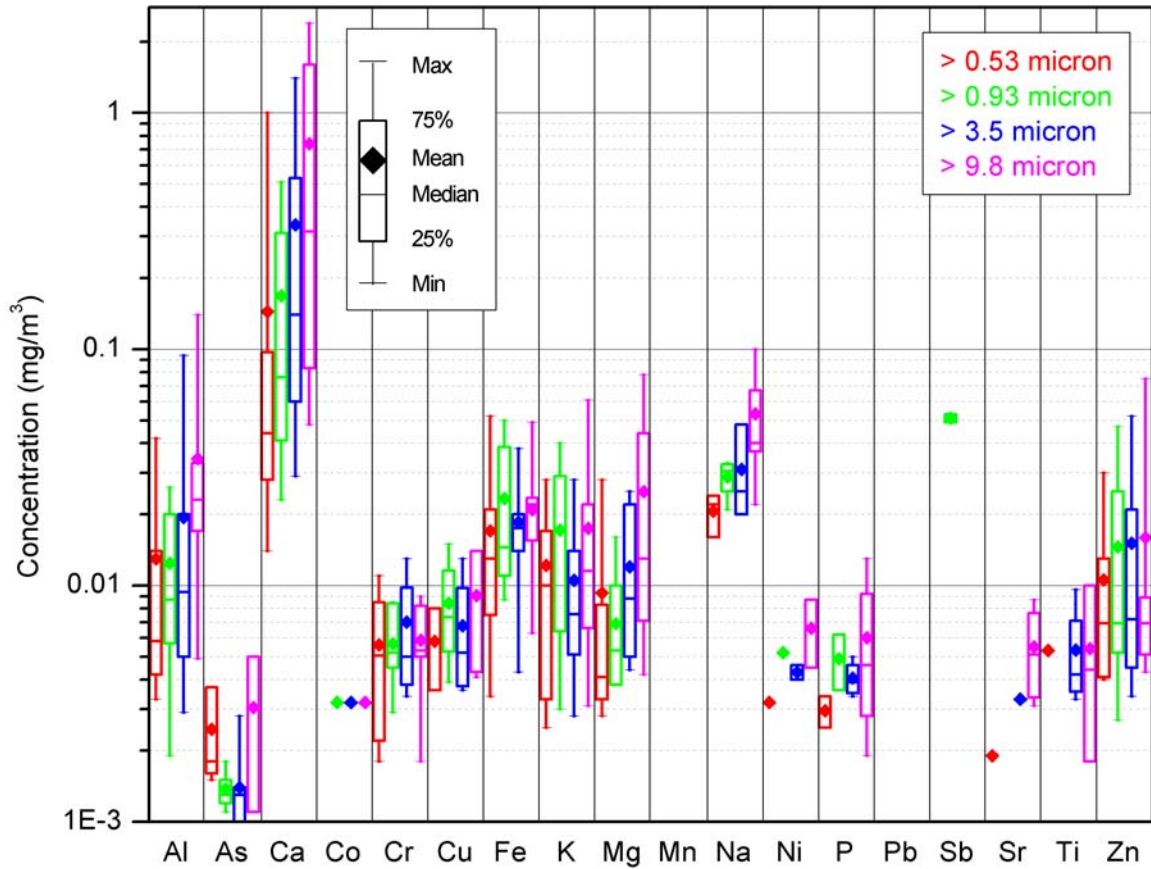


Figure 4-97: ICP elemental analysis of personal impactor collected smoke particles from large-scale fires.

**Table 4-67: Descriptive statistics for inorganic element concentrations measured in different sized smoke particles collected with personal impactors at large-scale fires.**

| Cut Plate   | Element | Number of samples <sup>[1]</sup> | Concentration (mg/m <sup>3</sup> ) <sup>[2]</sup> |         |         |         |         |          |
|-------------|---------|----------------------------------|---|---------|---------|---------|---------|----------|
|             |         |                                  | Minimum   | Q1      | Median  | Q3      | Maximum | Mean     |
| 0.52 micron | Al      | 10                               | 0.0033  | 0.00417 | 0.0058  | 0.019   | 0.042   | 0.01298  |
|             | As      | 5                                | 0.0015  | 0.00155 | 0.0018  | 0.0037  | 0.0037  | 0.00246  |
|             | Ca      | 10                               | 0.014   | 0.0265  | 0.044   | 0.0975  | 1       | 0.1443   |
|             | Co      | 0                                | na  | na      | na      | na      | na      | na       |
|             | Cr      | 6                                | 0.0018  | 0.0021  | 0.00505 | 0.00913 | 0.011   | 0.0056   |
|             | Cu      | 2                                | 0.0036  | na      | 0.0058  | na      | 0.008   | 0.0058   |
|             | Fe      | 9                                | 0.0034  | 0.00705 | 0.013   | 0.023   | 0.052   | 0.01706  |
|             | K       | 9                                | 0.0025  | 0.003   | 0.01    | 0.022   | 0.028   | 0.01214  |
|             | Mg      | 5                                | 0.0028  | 0.00305 | 0.0041  | 0.01815 | 0.028   | 0.0093   |
|             | Mn      | 0                                | na  | na      | na      | na      | na      | na       |
|             | Na      | 3                                | 0.016   | 0.016   | 0.022   | 0.024   | 0.024   | 0.02067  |
|             | Ni      | 1                                | 0.0032  | na      | 0.0032  | na      | 0.0032  | 0.0032   |
|             | P       | 2                                | 0.0025  | na      | 0.00295 | na      | 0.0034  | 0.00295  |
|             | Pb      | 0                                | na  | na      | na      | na      | na      | na       |
|             | Sb      | 0                                | na  | na      | na      | na      | na      | na       |
|             | Sr      | 1                                | 0.0019  | na      | 0.0019  | na      | 0.0019  | 0.0019   |
|             | Ti      | 1                                | 0.0053  | na      | 0.0053  | na      | 0.0053  | 0.0053   |
| Zn          | 7       | 0.004                            | 0.0041  | 0.0069  | 0.013   | 0.03    | 0.01056 |          |
| 0.93 micron | Al      | 13                               | 0.0019  | 0.00555 | 0.0087  | 0.022   | 0.026   | 0.01242  |
|             | As      | 5                                | 0.0011  | 0.00115 | 0.0013  | 0.00165 | 0.0018  | 0.00138  |
|             | Ca      | 13                               | 0.023   | 0.035   | 0.076   | 0.315   | 0.51    | 0.1684   |
|             | Co      | 1                                | 0.0032  | na      | 0.0032  | na      | 0.0032  | 0.0032   |
|             | Cr      | 7                                | 0.0029  | 0.0045  | 0.0052  | 0.0084  | 0.0085  | 0.005657 |
|             | Cu      | 4                                | 0.0039  | 0.00457 | 0.00735 | 0.01327 | 0.015   | 0.0084   |
|             | Fe      | 8                                | 0.0087  | 0.0105  | 0.0145  | 0.04125 | 0.05    | 0.02334  |
|             | K       | 7                                | 0.003   | 0.0064  | 0.017   | 0.029   | 0.04    | 0.01716  |
|             | Mg      | 10                               | 0.0038  | 0.0038  | 0.0053  | 0.01    | 0.016   | 0.00689  |
|             | Mn      | 0                                | na  | na      | na      | na      | na      | na       |
|             | Na      | 4                                | 0.021   | 0.023   | 0.0305  | 0.03275 | 0.033   | 0.02875  |
|             | Ni      | 1                                | 0.0052  | na      | 0.0052  | na      | 0.0052  | 0.0052   |
|             | P       | 2                                | 0.0036  | na      | 0.0049  | na      | 0.0062  | 0.0049   |
|             | Pb      | 0                                | na  | na      | na      | na      | na      | na       |
|             | Sb      | 2                                | 0.049   | na      | 0.051   | na      | 0.053   | 0.051    |
|             | Sr      | 0                                | na  | na      | na      | na      | na      | na       |
|             | Ti      | 0                                | na  | na      | na      | na      | na      | na       |
| Zn          | 7       | 0.0027                           | 0.0052  | 0.0069  | 0.025   | 0.047   | 0.01459 |          |

Note: <sup>[1]</sup> Limited to samples with sufficient particle mass collected for analysis (0.020 milligrams).  
<sup>[2]</sup> na = not applicable

Table 4-67 continued on next page.



**CONTINUED Table 4-67: Descriptive statistics for inorganic element concentrations measured in different sized smoke particles collected with personal impactors at large-scale fires.**

| Cut Plate  | Element | Number of samples <sup>[1]</sup> | Concentration (mg/m <sup>3</sup> ) <sup>[2]</sup> |         |         |         |         |          |
|------------|---------|----------------------------------|---|---------|---------|---------|---------|----------|
|            |         |                                  |   |         |         |         |         |          |
| 3.5 micron | Al      | 13                               | 0.0029  | 0.00445 | 0.0094  | 0.0265  | 0.094   | 0.01942  |
|            | As      | 5                                | 0.00072   | 0.00074 | 0.0013  | 0.0021  | 0.0028  | 0.001396 |
|            | Ca      | 14                               | 0.029   | 0.058   | 0.14    | 0.542   | 1.4     | 0.336    |
|            | Co      | 1                                | 0.0032  | na      | 0.0032  | na      | 0.0032  | 0.0032   |
|            | Cr      | 5                                | 0.0034  | 0.0036  | 0.005   | 0.0114  | 0.013   | 0.007    |
|            | Cu      | 4                                | 0.0036  | 0.00368 | 0.0052  | 0.01138 | 0.013   | 0.00675  |
|            | Fe      | 10                               | 0.0043  | 0.01175 | 0.0175  | 0.02375 | 0.038   | 0.01853  |
|            | K       | 8                                | 0.0028  | 0.0048  | 0.00755 | 0.0145  | 0.028   | 0.01051  |
|            | Mg      | 10                               | 0.0044  | 0.00492 | 0.0088  | 0.02225 | 0.025   | 0.01199  |
|            | Mn      | 0                                | na  | na      | na      | na      | na      | na       |
|            | Na      | 3                                | 0.02  | 0.02    | 0.025   | 0.048   | 0.048   | 0.031    |
|            | Ni      | 2                                | 0.004   | na      | 0.0043  | na      | 0.0046  | 0.0043   |
|            | P       | 4                                | 0.0034  | 0.00345 | 0.0039  | 0.0048  | 0.005   | 0.00405  |
|            | Pb      | 0                                | na  | na      | na      | na      | na      | na       |
|            | Sb      | 0                                | na  | na      | na      | na      | na      | na       |
|            | Sr      | 1                                | 0.0033  | na      | 0.0033  | na      | 0.0033  | 0.0033   |
|            | Ti      | 4                                | 0.0033  | 0.00342 | 0.0042  | 0.00835 | 0.0096  | 0.00532  |
| Zn         | 8       | 0.0034                           | 0.0044  | 0.0072  | 0.0265  | 0.052   | 0.0151  |          |
| 9.8 micron | Al      | 14                               | 0.0049  | 0.0165  | 0.023   | 0.03375 | 0.14    | 0.03442  |
|            | As      | 2                                | 0.0011  | na      | 0.00305 | na      | 0.005   | 0.00305  |
|            | Ca      | 14                               | 0.048   | 0.081   | 0.315   | 1.625   | 2.4     | 0.741    |
|            | Co      | 1                                | 0.0032  | na      | 0.0032  | na      | 0.0032  | 0.0032   |
|            | Cr      | 5                                | 0.0018  | 0.0034  | 0.0053  | 0.0086  | 0.009   | 0.00586  |
|            | Cu      | 6                                | 0.0041  | 0.00425 | 0.00905 | 0.014   | 0.014   | 0.00908  |
|            | Fe      | 16                               | 0.0063  | 0.01525 | 0.022   | 0.02375 | 0.049   | 0.02095  |
|            | K       | 10                               | 0.0031  | 0.00585 | 0.0115  | 0.025   | 0.061   | 0.01745  |
|            | Mg      | 13                               | 0.0042  | 0.00645 | 0.013   | 0.0485  | 0.078   | 0.02498  |
|            | Mn      | 0                                | na  | na      | na      | na      | na      | na       |
|            | Na      | 5                                | 0.022   | 0.0295  | 0.04    | 0.0835  | 0.1     | 0.0532   |
|            | Ni      | 2                                | 0.0045  | na      | 0.0066  | na      | 0.0087  | 0.0066   |
|            | P       | 6                                | 0.0019  | 0.00258 | 0.0046  | 0.01015 | 0.013   | 0.00602  |
|            | Pb      | 0                                | na  | na      | na      | na      | na      | na       |
|            | Sb      | 0                                | na  | na      | na      | na      | na      | na       |
|            | Sr      | 4                                | 0.0031  | 0.00322 | 0.0051  | 0.00818 | 0.0087  | 0.0055   |
|            | Ti      | 3                                | 0.0018  | 0.0018  | 0.0044  | 0.01    | 0.01    | 0.0054   |
| Zn         | 13      | 0.0043                           | 0.00495   | 0.0069  | 0.01095 | 0.075   | 0.01594 |          |

Note: <sup>[1]</sup> Limited to samples with sufficient particle mass collected for analysis (0.020 milligrams).

<sup>[2]</sup> na = not applicable

Comparison of NIOSH and OSHA exposure limits to the measured inorganic element concentrations, Table 4-68, indicates that eight-hour time weighted average (TWA) exposures were not exceeded at any fire when assuming there was no additional exposure beyond that of the fire scene for the balance of the eight hour period. Short-term exposures calculated assuming all of the measured concentrations were accumulated during a 15 minute window did not exceed

NIOSH STEL at any of the fires. The STEL for arsenic, 0.002 mg/m<sup>3</sup>, was exceeded in the bedroom, kitchen, attic, and composite deck fires and possibly also at the limited ventilation living room fire. In the bedroom, attic, and composite deck fires the arsenic STEL was exceeded in a single particle size range: the largest particles (>9.8 micron) for the bedroom fire, the second largest particles (>3.5 micron) for the attic fire, and the smallest particles (> 0.52 micron) for the composite deck fire. While no individual particle size range exceeded the arsenic STEL for the kitchen fire (averaged over 30 minutes), the aggregate concentration for the 4 size ranges did exceed the STEL. In the limited ventilation living room fire arsenic concentrations exceeded 0.001 mg/m<sup>3</sup> for the 32 minute sampling period; hence, it is theoretically possible that the arsenic STEL was also exceeded at this fire. NIOSH IDLH concentrations are also presented in Table 4-68 for the reader's reference despite limitations of the utilized collection method that prohibit direct comparison.

**Table 4-68: Number of large-scale fires in which inorganic element concentrations for personal impactor collected smoke particles exceeded various recommended exposure limits.**

| Element          | NIOSH TWA <sup>[1]</sup><br>(mg/m <sup>3</sup> ) | Fires Exceeding TWA | NIOSH STEL<br>(mg/m <sup>3</sup> ) | Fires Exceeding STEL                                   | NIOSH IDLH<br>(mg/m <sup>3</sup> ) |
|------------------|--|---------------------|------------------------------------|--|------------------------------------|
| Aluminum (Al)    | 5 <sup>[2]</sup>                                 | none                |                                    |  |                                    |
| Antimony (Sb)    | 0.5  | none                |                                    |  | 50                                 |
| Arsenic (As)     | 0.01 <sup>[3]</sup>                              | none                | 0.002                              | Bedroom, Kitchen, Attic, Composite Deck <sup>[4]</sup> | 5                                  |
| Chromium (Cr)    | 0.5  | none                |                                    |  | 250                                |
| Cobalt (Co)      | 0.05   | none                |                                    |  | 20                                 |
| Copper (Cu) dust | 1  | none                |                                    |  | 100                                |
| Iron oxide (FeO) | 5  | none                |                                    |  | 2,500                              |
| Lead (Pb)        | 0.05   | none                |                                    |  | 100                                |
| Manganese (Mn)   | 1  | none                | 3                                  | none   | 500                                |
| Nickel (Ni)      | 0.015  | none                |                                    |  | 10                                 |
| Phosphorus (P)   | 0.1  | none                |                                    |  | 5                                  |

Notes: <sup>[1]</sup> Where possible NIOSH limits are used as they are more conservative than OSHA limits

<sup>[2]</sup> Respirable

<sup>[3]</sup> OSHA limit

<sup>[4]</sup> It is also theoretically possible that the STEL was exceeded at the limited ventilation living room fire.

## CHAPTER 5: CONTROLLED FIELD FIRE EVENTS

### 5.0 INTRODUCTION

Controlled field events were conducted to establish a link between combustion gases and airborne smoke particulates measured for the large-scale laboratory fire tests (Chapter 4) and the field events responded to by the Chicago Fire Department (Chapter 6).

### 5.1 FIRE EVENTS

A series of individual room fires were conducted in an old farmhouse, Figure 5-1, to create representative burn patterns observed in practice.



**Figure 5-1: Farmhouse that was utilized to conduct controlled field fire events.**

The five evaluated fire scenarios included:

1. Study/Small bedroom
2. Bathroom
3. Kitchen
4. Master bedroom
5. Child's bedroom

For each of the scenarios, personal gas monitors and cascade impactors were used by two firefighters to assess smoke and gases during the suppression and overhaul activities. The OP-FTIR was implemented to determine the gases contained in the smoke plume.

Because the conducted fire scenarios are being used to train fire investigators, some ignition and fire propagation details have been intentionally omitted.

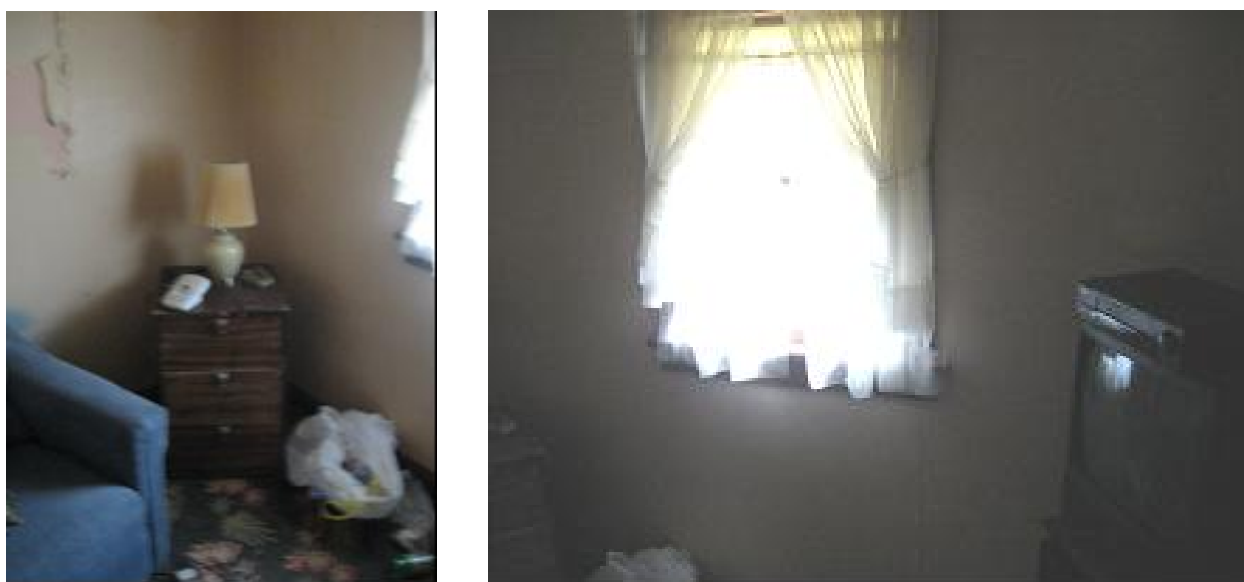
#### 5.1.1 Study/Small Bedroom

The study/small bedroom (first floor, south side of house) fire was initiated with the chair as the first item ignited. The fire was allowed to propagate to flashover and continue burning for a couple of minutes (approximately 12 minutes from ignition) before suppression and overhaul activities commenced. A room window was left partially open during the test, allowing generated smoke to escape to the outside.

Instrumented fire service personnel remained in the adjoining hallway for the duration of the fire and followed the hose team in for suppression and overhaul. Service responder #1 was the lead instrumented responder for this fire. As such responder #1 stood closer to the doorway than responder #2, entered the fire scene earlier than responder #2, and penetrated deeper into the fire scene.

The OP-FTIR was operated in active mode for this scenario. The spectrometer and IR source were positioned such that the beam path was parallel along the window wall approximately 0.3 m out from the top of the window. An optical path length corresponding to the width of the emitted smoke plume of 0.9 m was used for the gas concentration calculations.

Photographs of the room are shown in Figure 5-2.



**Figure 5-2: Study/Small bedroom prior to controlled field fire event.**

### **5.1.2 Bathroom**

The bathroom (first floor, south side of house) fire was initiated with the window drape as the first item ignited. The fire was allowed to propagate for approximately 5 minutes prior to commencing suppression and overhaul activities. The room window was kept open about 2 in. (5 cm) during the test.

Instrumented fire service remained in the adjoining hallway for the duration of the fire and overhaul. The OP-FTIR was not operated for this fire because of the absence of exterior venting.

### **5.1.3 Kitchen**

The kitchen (first floor, northeast side of house) fire was initiated in the cabinet/counter space area using several paper towels and newspaper. The fire was allowed to propagate to flashover and continue burning for a couple of minutes (approximately 9 minutes from ignition) before

suppression and overhaul activities commenced. A room window was left partially open during the test allowing generated smoke to escape to the outside.

Instrumented fire service remained in the adjoining living room for the duration of the fire and followed the hose team in for suppression and overhaul. Service responder #1 was the lead instrumented responder for this fire. As such responder #1 stood closer to the doorway than responder #2, entered the fire scene earlier than responder #2 and penetrated deeper into the fire scene.

The OP-FTIR was operated in the passive mode aimed at the smoke plume escaping through the open window. The OP-FTIR was positioned approximately 10.9 m from the smoke plume.

Photographs of the room and the ignition source are shown in Figure 5-3.



**Figure 5-3: Kitchen prior to controlled field fire event. Kitchen ignition source is depicted in the bottom figure.**

### 5.1.4 Master Bedroom

The master bedroom (second floor, west side of house) fire was initiated with the mattress serving as the first item ignited. The fire was allowed to propagate for approximately 10 minutes before suppression and overhaul activities commenced. A room window was left partially open during the test allowing generated smoke to escape to the outside.

Instrumented fire service remained in the adjoining hallway for the duration of the fire and followed the hose team in for suppression and overhaul. Service responder #2 was the lead instrumented responder for this fire. As such responder #2 stood closer to the doorway than responder #1, entered the fire scene earlier than responder #1 and penetrated deeper into the fire scene.

The OP-FTIR was operated in the passive mode aimed at the smoke plume escaping through the open window. The OP-FTIR was positioned approximately 10.8 m from the smoke plume.

Photographs of the room are shown in Figure 5-4.



Figure 5-4: Master bedroom prior to controlled field fire event.

### 5.1.5 Child's Bedroom

The Child's bedroom (second floor, northeast side of house) fire was initiated in the corner where the toys were located. The fire was allowed to propagate for flashover and continue burning for a couple of minutes (approximately 16 minutes from ignition) before suppression and overhaul activities commenced. A room window was left partially open during the test allowing generated smoke to escape to the outside.

Instrumented fire service remained in the adjoining hallway for the duration of the fire and followed the hose team for suppression and overhaul. Service responder #2 was the lead

instrumented responder for this fire. As such responder #2 stood closer to the doorway than responder #1, entered the fire scene earlier than responder #1 and penetrated deeper into the fire scene.

The OP-FTIR was operated in the passive mode aimed at the smoke plume escaping through the open window. The OP-FTIR was positioned approximately 8.8 m from the smoke plume.

Photographs of the room are shown in Figure 5-5.



Figure 5-5: Child's bedroom prior to controlled field fire event.

## 5.2 EXPERIMENTAL

### 5.2.1 Personal Air Sampling – Gas

Firefighters were outfitted with 6-gas direct-reading personal gas monitors as described in Section 2.4. Monitors were calibrated prior to the test fire. Personal air monitoring at the fire scene was initiated prior to fire initiation and continued until suppression and overhaul were completed.

### 5.2.2 Personal Air Sampling – Smoke Particle Size Distribution

Airborne smoke particles in the firefighters personal area were collected using the four-stage personal cascade impactor described in Section 2.5. Sampling was initiated prior to fire initiation and continued until suppression and overhaul were completed. Each cut plate and the final filter from the used impactor was gravimetrically analyzed to determine the mass distribution of the collected particle sizes.

### 5.2.3 Personal Air Sampling – Smoke Particle Inorganic Content

Smoke particles collected on the different impactor cut plates were analyzed by inductively coupled plasma/mass spectroscopy (ICP/MS) for their inorganic element content (ICP-MS is

described in Section 2.7). Phosphorus (P) concentration was measured using a modified NIOSH 7300 protocol, arsenic (As) concentration using a modified NIOSH 7303 protocol, and a modified OSHA ID-125G protocol was used to measure aluminum (Al), antimony (Sb), barium (Ba), beryllium (Be), cadmium (Cd), calcium (Ca), chromium (Cr), cobalt (Co), copper (Cu), iron (Fe), lead in air (Pb), lithium (Li), magnesium (Mg), manganese (Mn), molybdenum (Mb), nickel (Ni), potassium (K), selenium (Se), silver (Ag), sodium (Na), strontium (Sr), thallium (Tl), tin (Sn), titanium (Ti), vanadium (V), and zinc (Zn) concentrations.

### 5.2.4 Effluent Gas Composition

Effluent gases escaping through the open windows were analyzed using the OP-FTIR described in Section 2.2. For the study/small bedroom fire the OP-FTIR was operated in the active mode with the spectrometer and the infrared energy source located on opposite sides of the escaping smoke plume. For the kitchen, master bedroom, and child's bedroom the OP-FTIR was operated in the passive mode with the spectrometer aimed directly at the escaping fire plume.

## 5.3 RESULTS

### 5.3.1 Study/Small Bedroom and Bathroom

The extent to which the fire spread throughout the study/small bedroom is depicted in Figure 5-6.

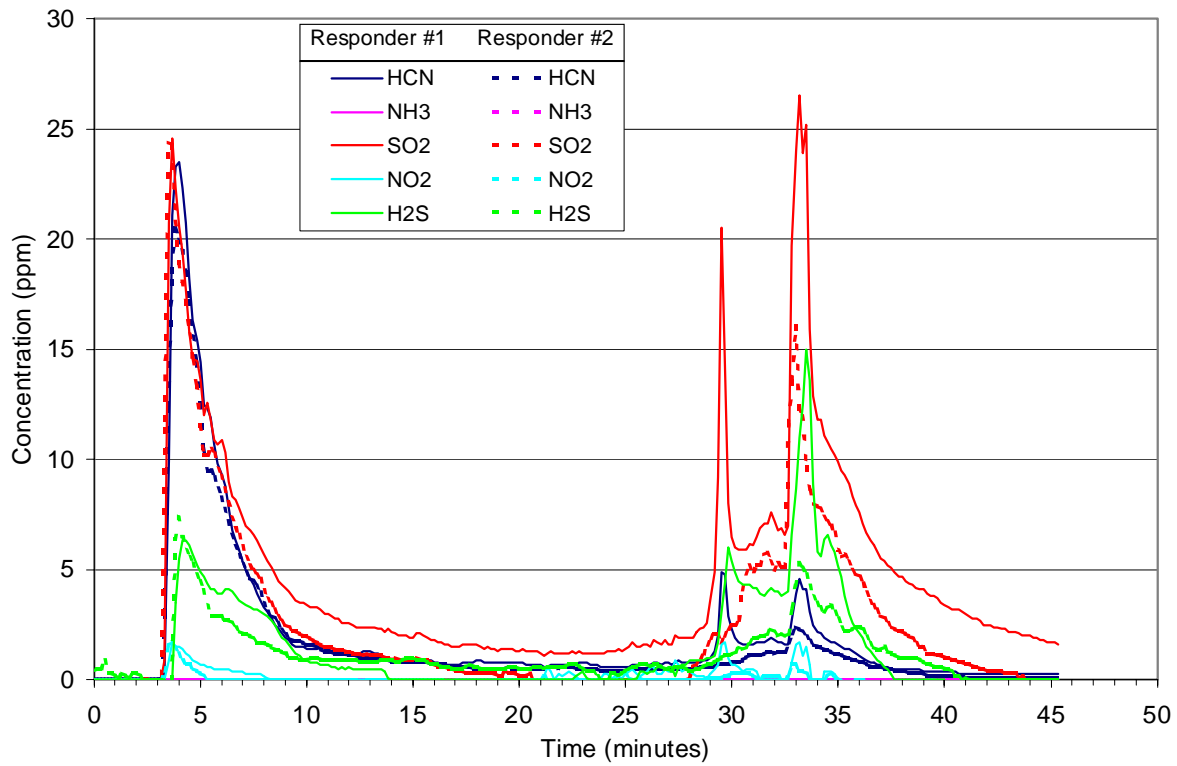
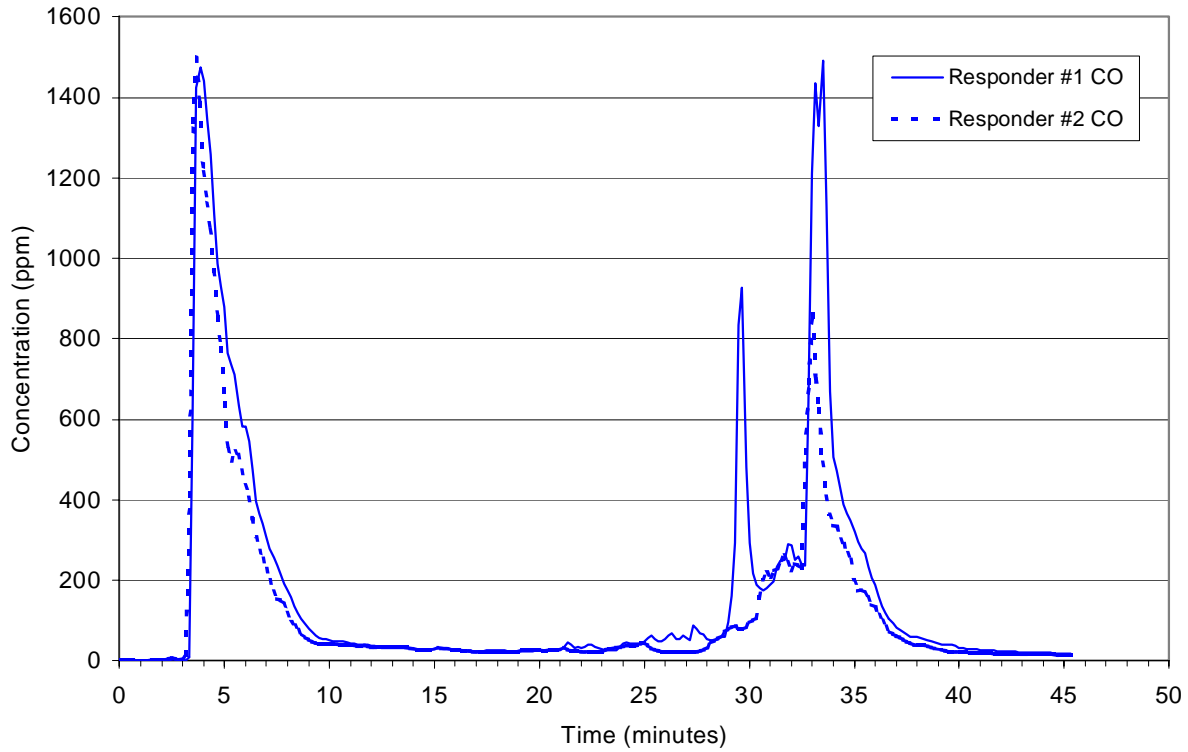


**Figure 5-6: Study/Small bedroom after controlled field fire event.**

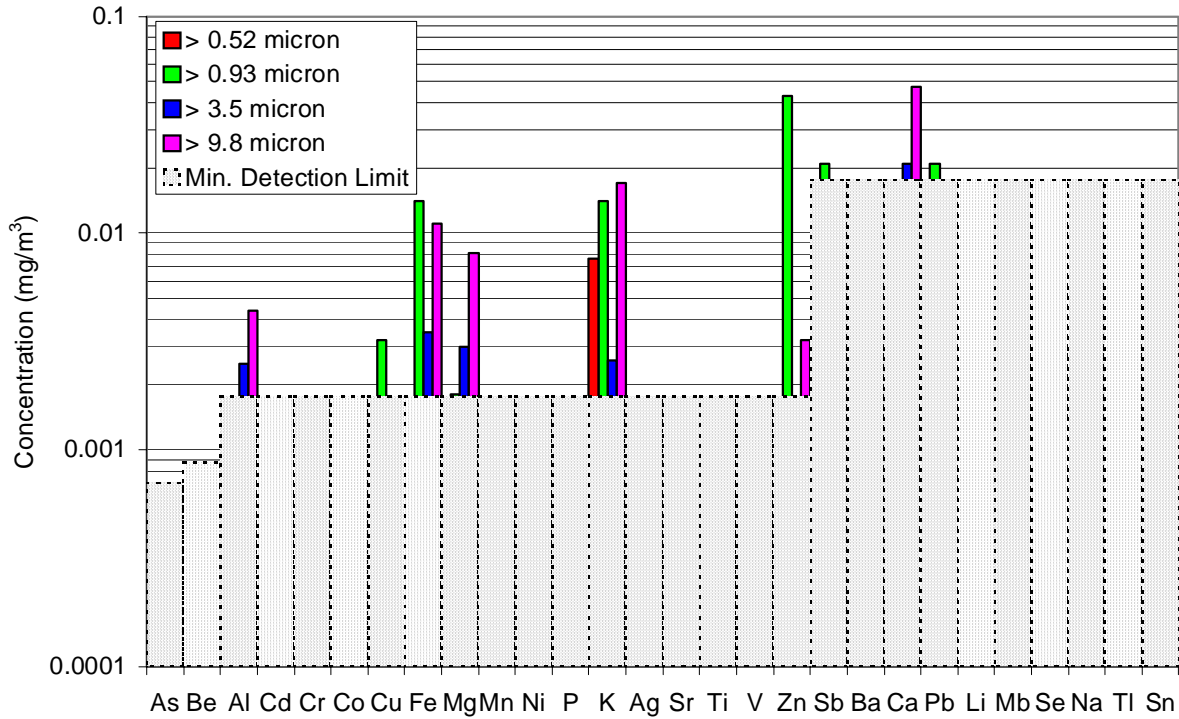
Two firefighters wore personal gas monitors (and impactors) before, during, and after the overhaul activities for the two fires. Measured gas concentrations for the study/small bedroom and bathroom (ignited approximately 25 minutes later) are plotted in Figure 5-7. One of the firefighters also wore a personal impactor to collect smoke particulates generated by the two fires. Inorganic elemental analysis of the collected particulates is plotted in Figure 5-8.

Relative concentrations of gases other than water and carbon dioxide in the escaping study/small bedroom smoke plume measured with the OP-FTIR system are plotted in Figure 5-9.

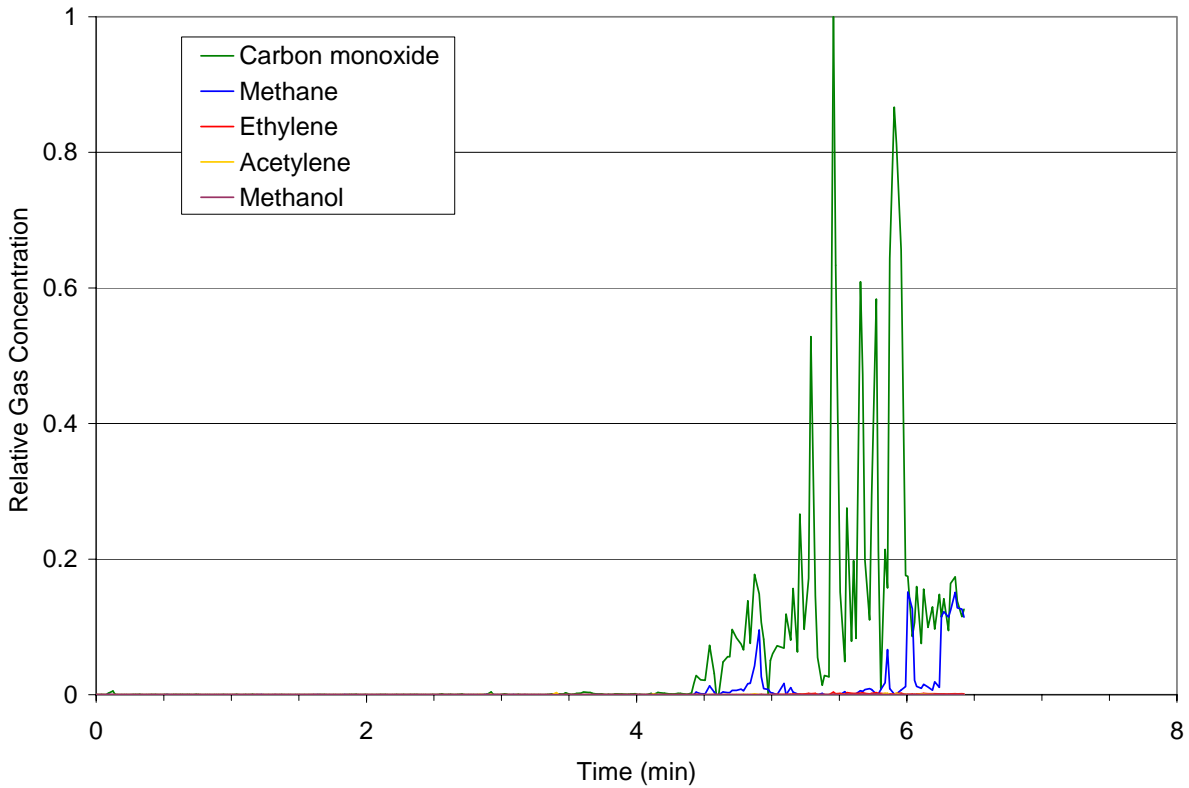




**Figure 5-7: Gas concentrations measured by personal monitors for the study/small bedroom fire followed by the bathroom fire.**



**Figure 5-8: Inorganic element concentrations measured for smoke particles collected using personal cascade impactor for the study/small bedroom fire followed by the bathroom fire.**



**Figure 5-9: Relative gas concentrations determined by OP-FTIR for the study/small bedroom fire.**

### 5.3.2 Kitchen

As seen in the post-fire photographs of the kitchen, Figure 5-10, the kitchen suffered extensive damage.



**Figure 5-10: Kitchen after the controlled field fire event.**

Two firefighters wore personal gas monitors (and impactors) before, during, and after the overhaul activities. Measured gas concentrations are plotted in Figure 5-11. One of the firefighters also wore a personal impactor to collect smoke particulates. Inorganic elemental analysis of the collected particulates is plotted in Figure 5-12.

Relative concentrations of gases other than water and carbon dioxide in the escaping smoke plume measured with the OP-FTIR system are plotted in Figure 5-13.

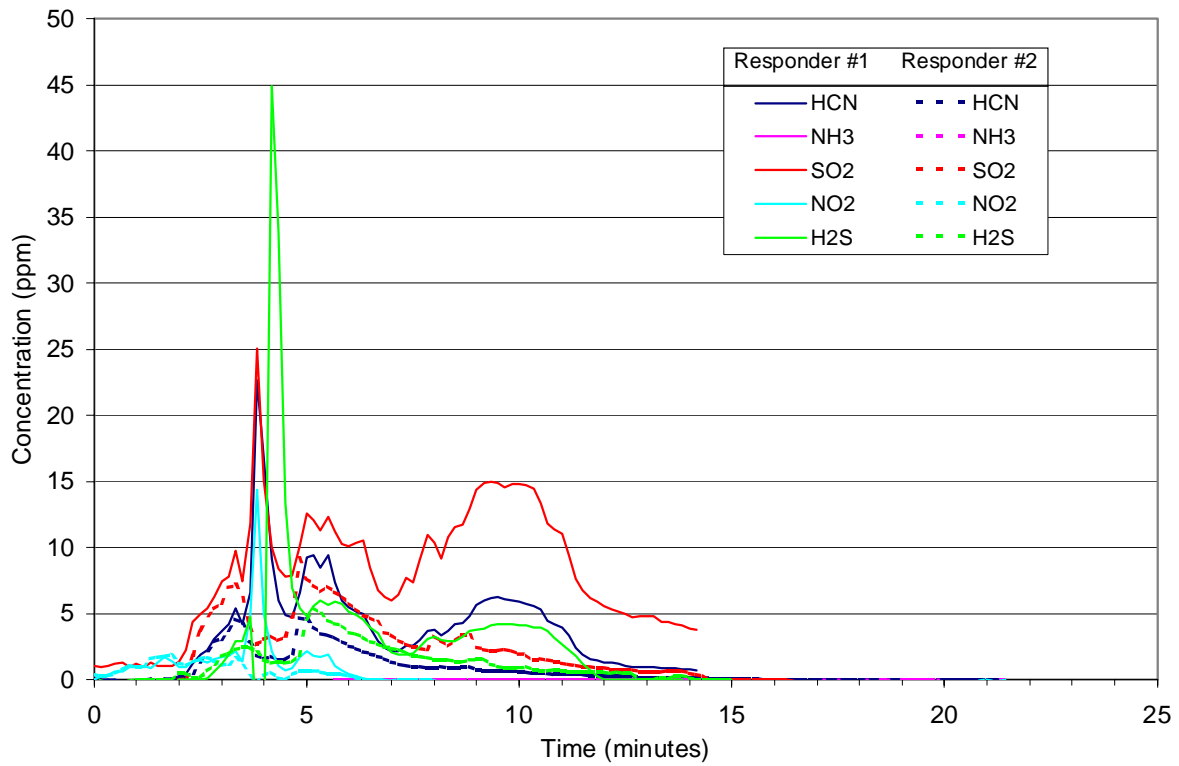
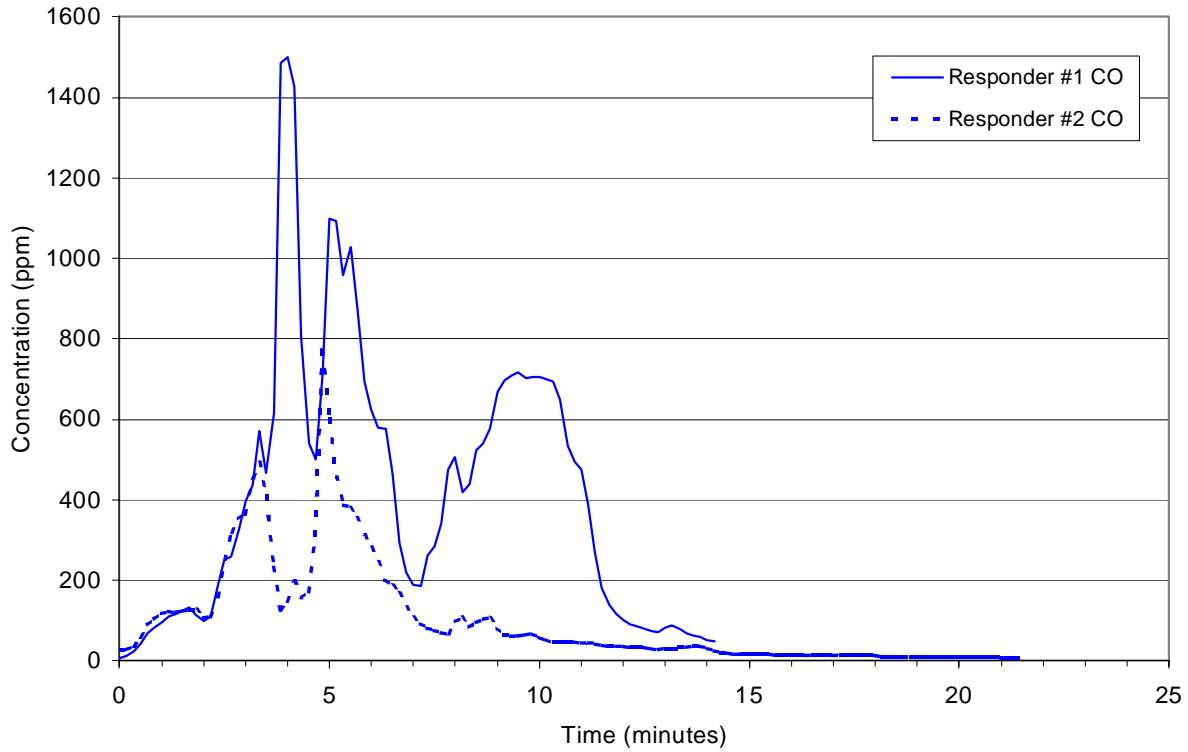
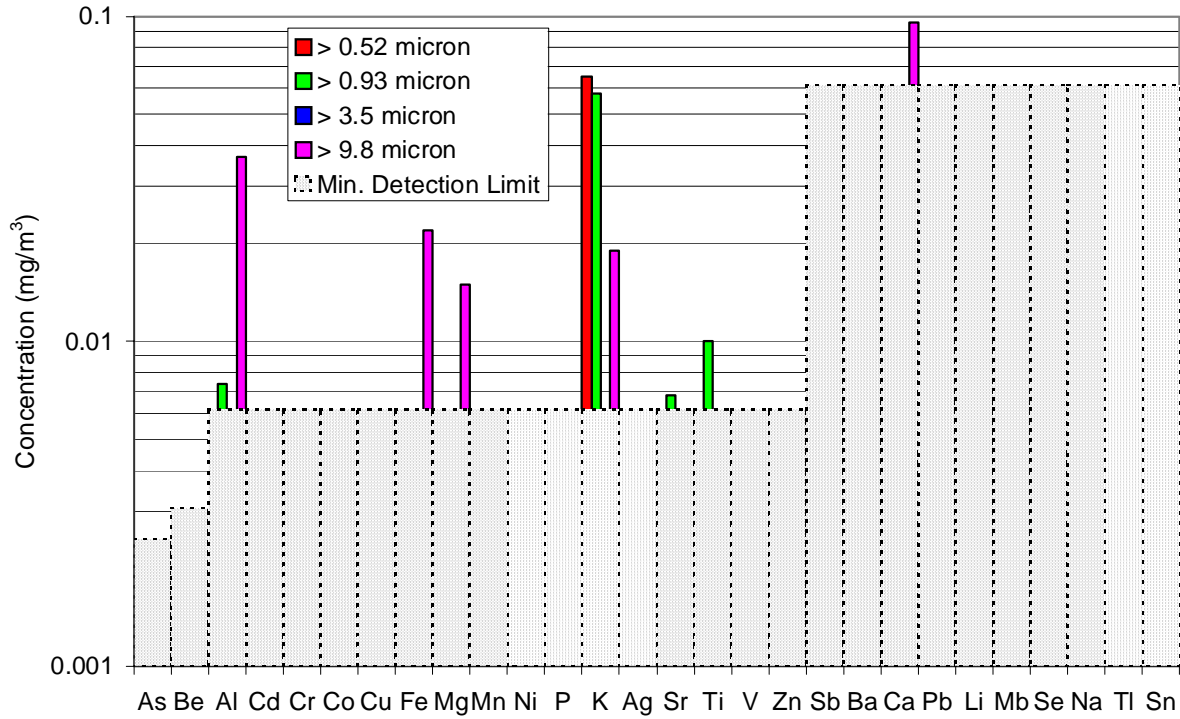
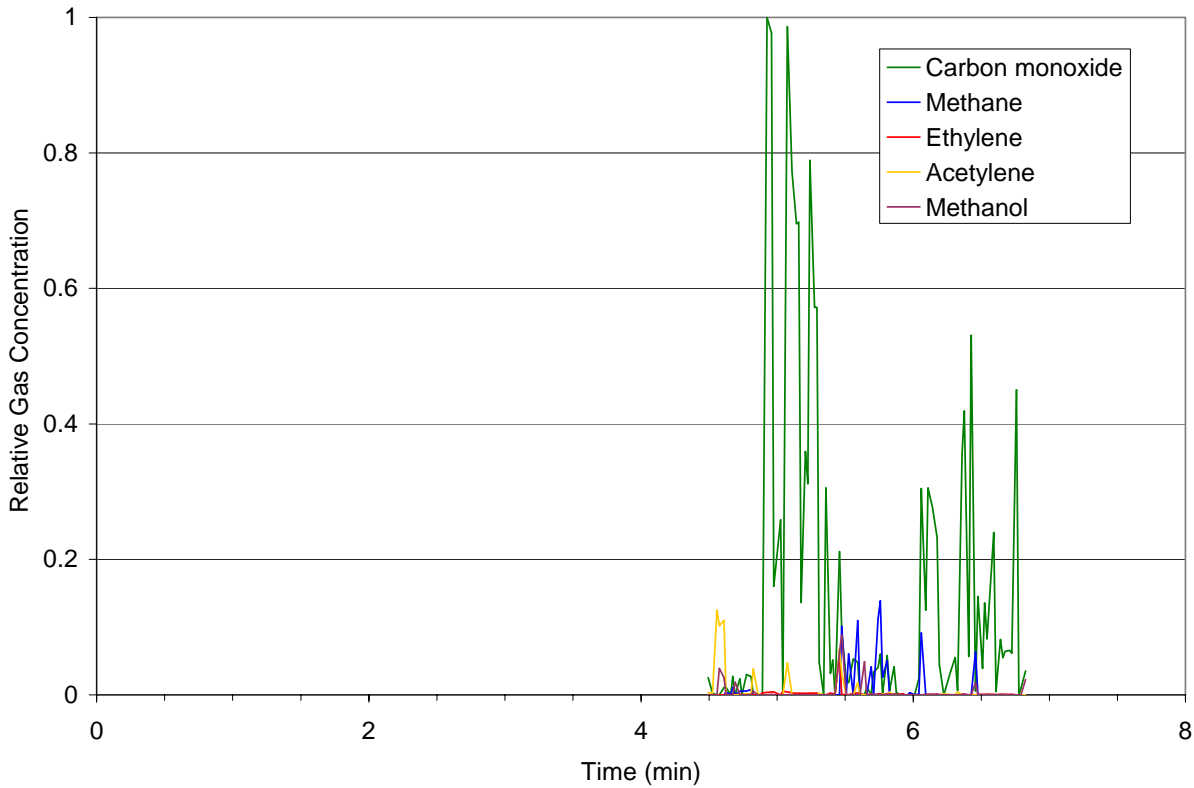


Figure 5-11: Gas concentrations measured by personal monitors for the kitchen fire.



**Figure 5-12: Inorganic element concentrations measured for smoke particles collected using personal cascade impactor for the kitchen fire.**

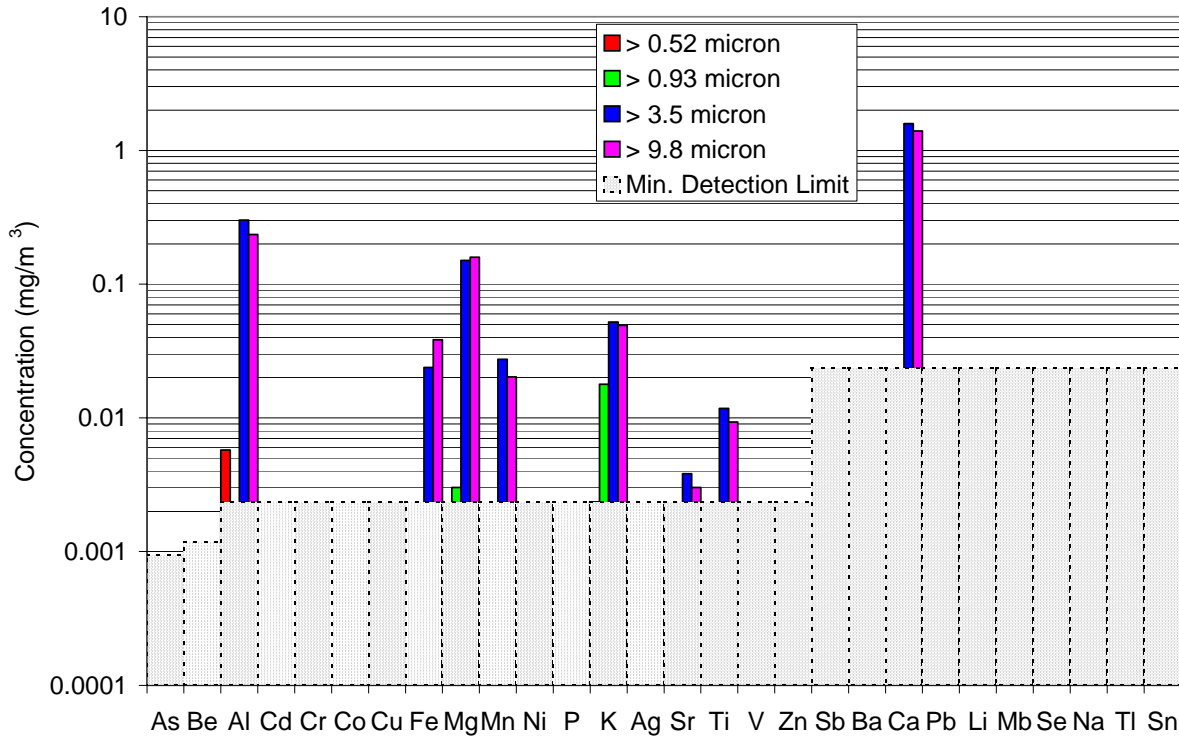


**Figure 5-13: Relative gas concentrations determined by OP-FTIR for the kitchen fire.**

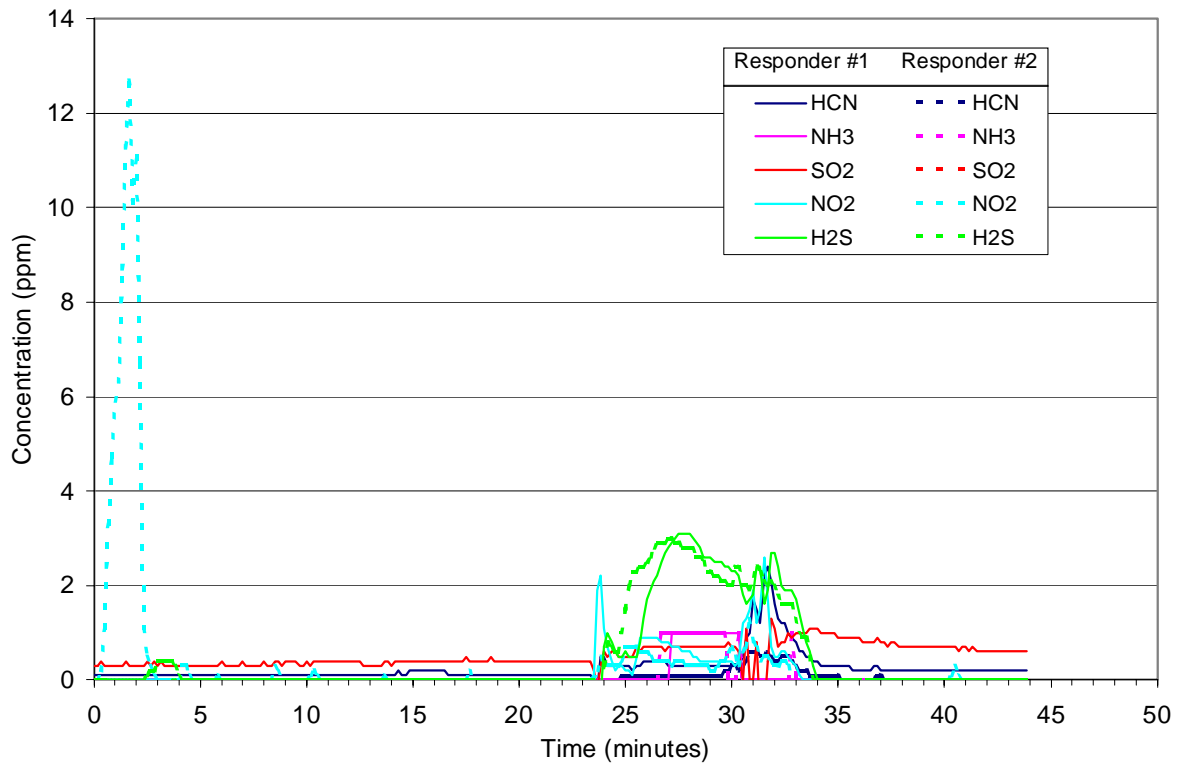
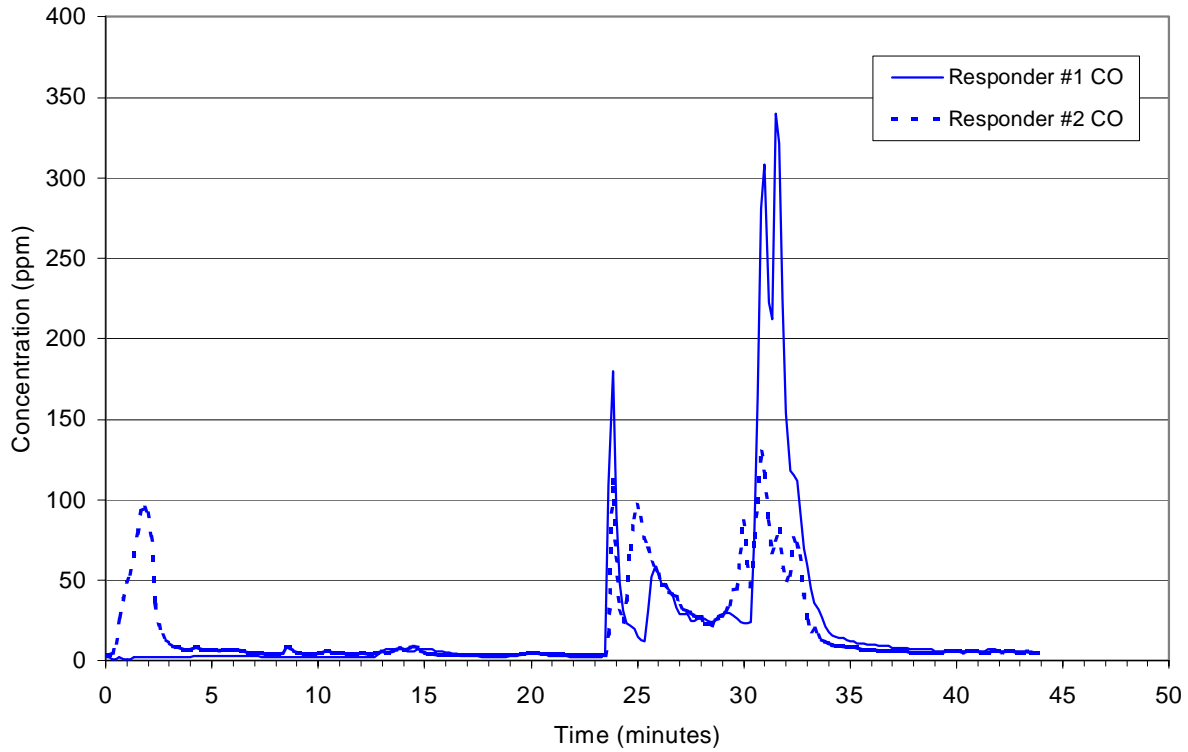
**5.3.3 Master bedroom**

Two firefighters wore personal gas monitors (and impactors) before, during, and after the overhaul activities. Inorganic elemental analysis of the collected particulates is plotted in Figure 5-14. Measured gas concentrations are plotted in Figure 5-15. One of the firefighters also wore a personal impactor to collect smoke particulates.

The OP-FTIR was operated in the passive mode for this fire scenario; however, the fire did not generate sufficient heat and overall growth in order for reliable measurements to be taken.



**Figure 5-14: Inorganic element concentrations measured for smoke particles collected using personal cascade impactor for the master bedroom fire.**



**Figure 5-15: Gas concentrations measured by personal monitors for the master bedroom fire.**

### 5.3.4 Child's bedroom

The final fire scenario was conducted in a child's bedroom located on the second floor (northeast side of house). Figure 5-16 shows the post-fire damage to the child's bedroom.

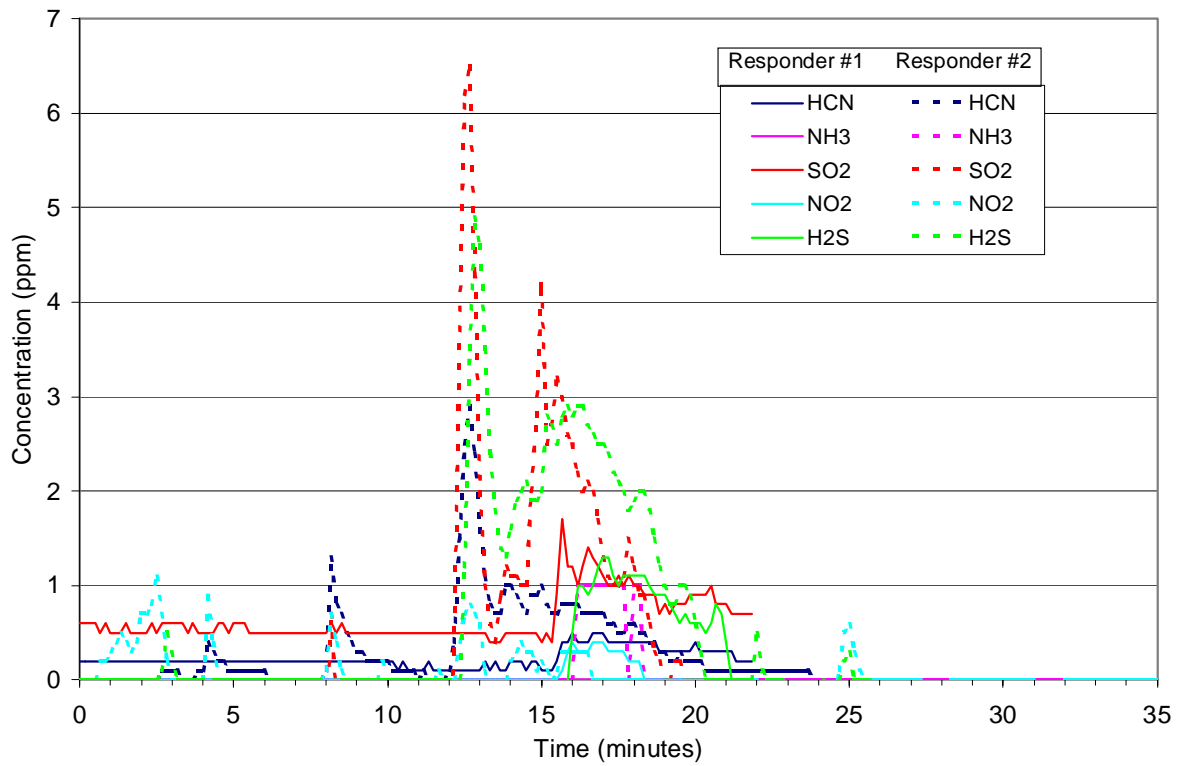
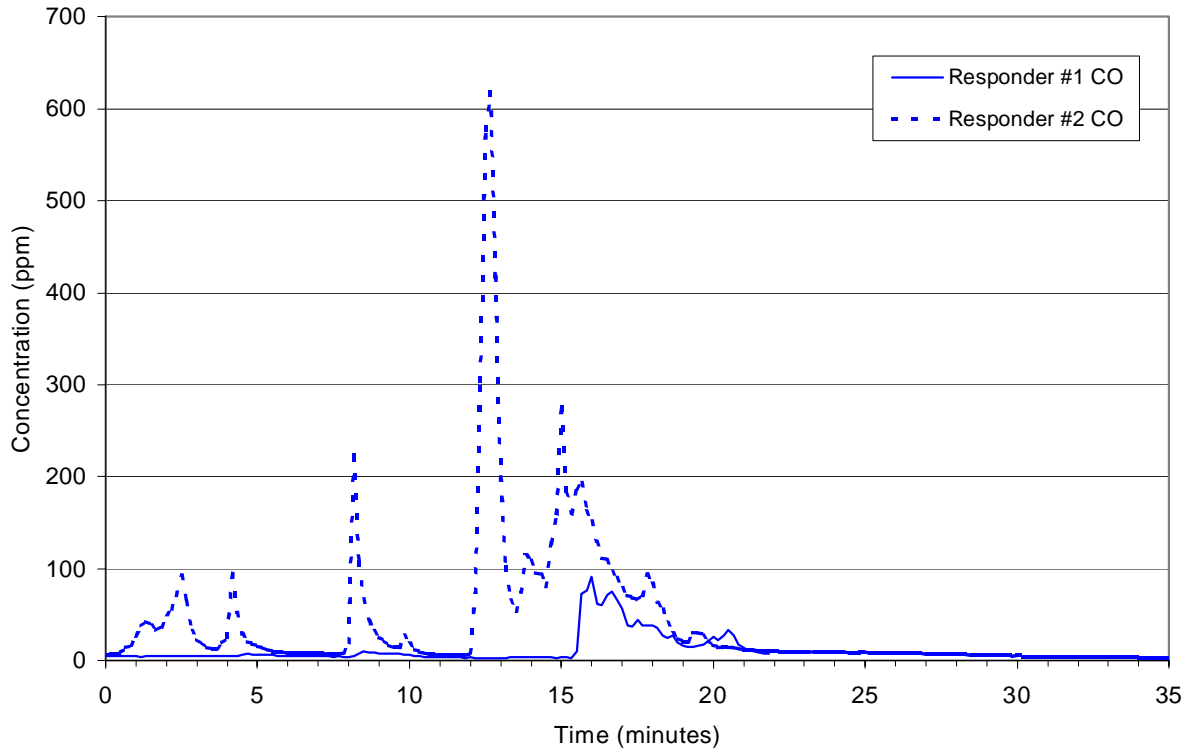


**Figure 5-16: Child's bedroom after the controlled field fire event.**

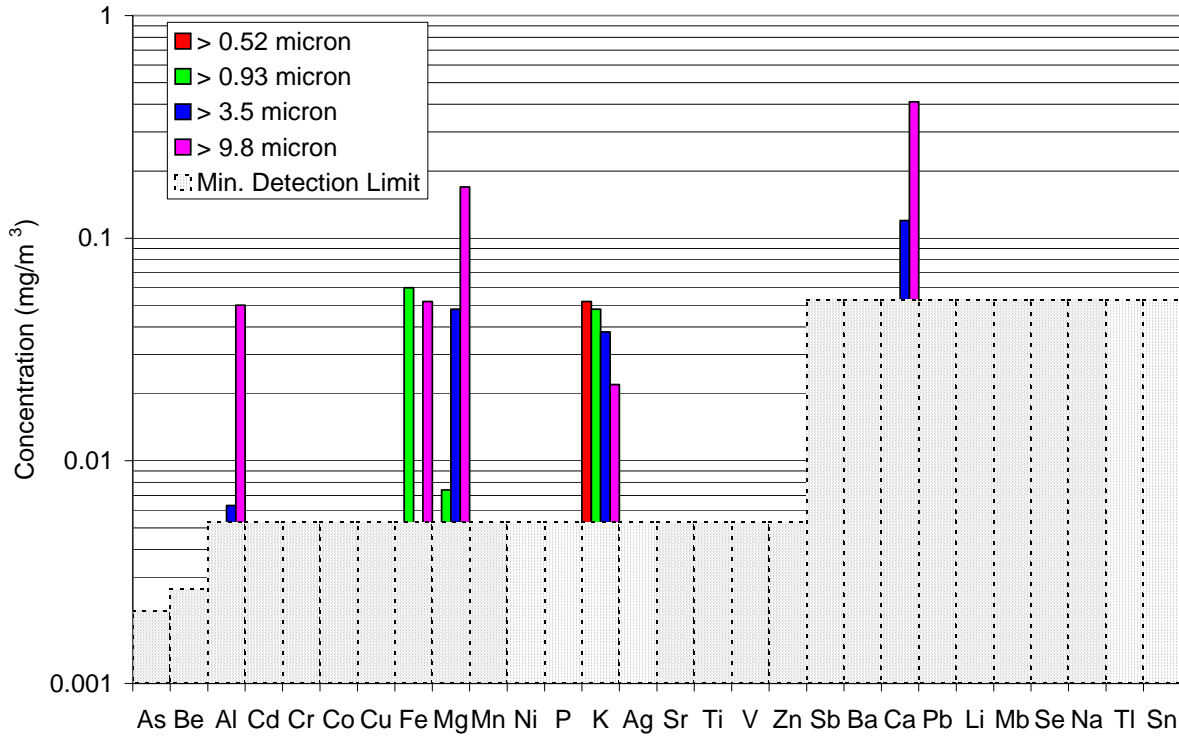
Two firefighters wore personal gas monitors (and impactors) before, during, and after the overhaul activities. Measured gas concentrations are plotted in Figure 5-17. One of the firefighters also wore a personal impactor to collect smoke particulates. Inorganic elemental analysis of the collected particulates is plotted in Figure 5-18.

Relative concentrations of gases other than water and carbon dioxide in the escaping smoke plume measured with the OP-FTIR system are plotted in Figure 5-19.

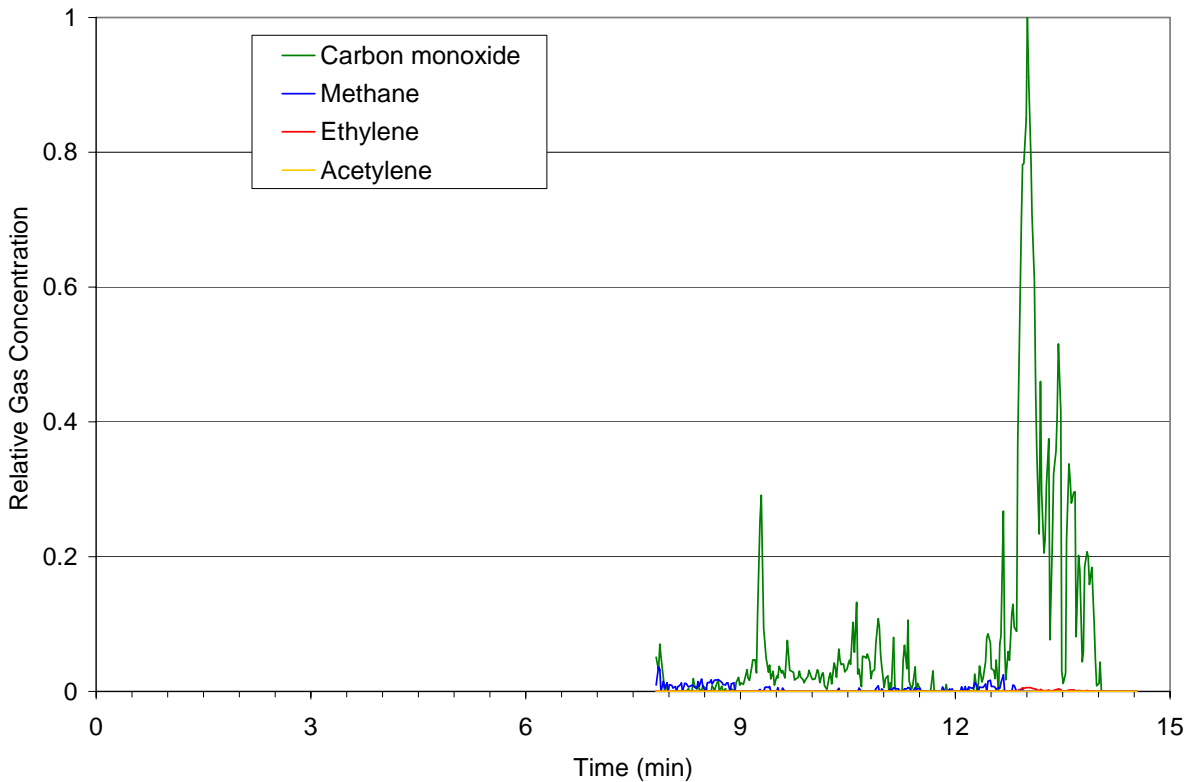




**Figure 5-17: Gas concentrations measured by personal monitors for the child’s bedroom fire.**



**Figure 5-18: Inorganic element concentrations measured for smoke particles collected using personal cascade impactor for the child’s bedroom fire.**



**Figure 5-19: Relative gas concentrations determined by OP-FTIR for the child’s bedroom fire.**

## 5.4 SUMMARY

### 5.4.1 Personal Air Sampling – Gas

Comparison of the recorded gas concentrations to NIOSH and OSHA exposure limits, Table 5-1, indicates that only the carbon monoxide IDLH limit were exceeded in any of the fires, however the carbon monoxide limit was exceeded in three fires: study/small bedroom, bathroom, and kitchen. Short-term exposure limits (STEL) developed for 10 or 15 minute exposure time frames were exceeded in the same fires for sulfur dioxide and carbon monoxide. Nitrous oxide STEL was exceeded in the master bedroom fire, presumably due in part to the larger quantity of polyurethane foam used in the larger mattress and in part to the fire not reaching flashover conditions. Eight hour time weighted average (TWA) exposures were calculated for each fire exposure such that there was no gas exposure for the balance of the eight hour period, Table 5-1. TWA limits were not exceeded for any of the gases in any of the fires.

**Table 5-1: Number of controlled field fires in which gas concentrations exceeded various recommended exposure limits.**

| Gas              | NIOSH IDLH (ppm) | Fires Exceeding IDLH     | NIOSH STEL (ppm)   | Fires Exceeding STEL     | TWA <sup>[2]</sup> (ppm) | Fires Exceeding TWA |
|------------------|------------------|--------------------------|--------------------|--------------------------|--------------------------|---------------------|
| HCN              | 50               | none                     | 4.7                | none                     | 10 <sup>[3]</sup>        | none                |
| NH <sub>3</sub>  | 300              | none                     | 35                 | none                     | 25                       | none                |
| SO <sub>2</sub>  | 100              | none                     | 5                  | Study, Bathroom, Kitchen | 2                        | none                |
| NO <sub>2</sub>  | 20               | none                     | 1                  | Master bedroom           | 5 <sup>[3]</sup>         | none                |
| H <sub>2</sub> S | 100              | none                     | 10 <sup>[1]</sup>  | None                     | 10                       | none                |
| CO               | 1,200            | Study, Bathroom, Kitchen | 200 <sup>[1]</sup> | Study, Bathroom, Kitchen | 35                       | none                |

Notes: <sup>[1]</sup> 10 minute exposure limits

<sup>[2]</sup> Where possible NIOSH limits are used as they are more conservative than OSHA limits

<sup>[3]</sup> OSHA limit

Although carbon monoxide was the only gas to exceed IDLH limits, it was not the only gas to exceed the STEL. And in the case of the master bedroom fire, carbon monoxide did not exceed IDLH or STEL recommended exposure limits yet nitrous oxide did. This suggests that carbon monoxide monitoring may provide firefighters a first line of gas exposure threat warning but does not provide warning of other gases that may be present in excess of recommended exposure limits.

### 5.4.2 Personal Air Sampling – Smoke Particle Size Distribution

Analysis of the smoke particles accumulated on the four personal cascade impactor cut plates (0.52, 0.93, 3.5, 9.8 micron), Figure 5-20, reveals that the relative mass distributions are similar for the different fires with the exception of the master bedroom fire. The master bedroom fire did not reach the greater burning intensities characteristic of flashover like the other controlled field fires. Lower burning intensity has been seen to result in greater densities of larger particles.

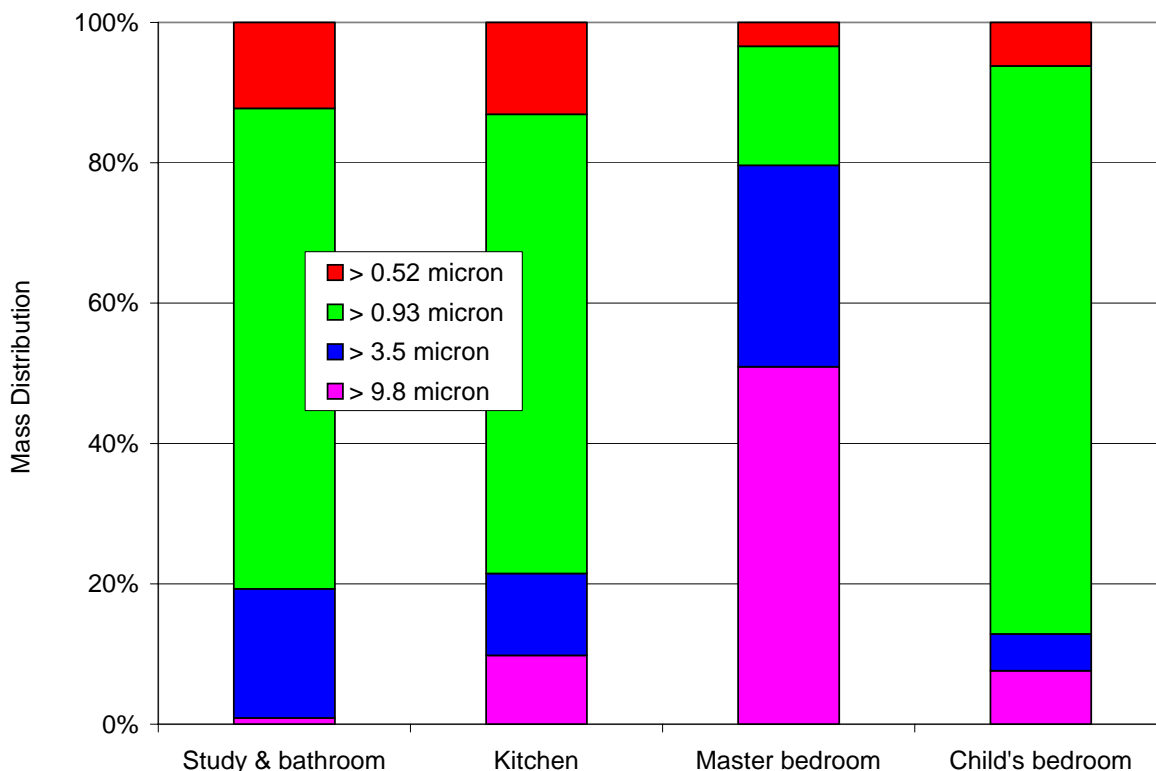


Figure 5-20: Smoke particle size distribution for personal impactors used in the controlled field fire events.

### 5.4.3 Personal Air Sampling – Smoke Particle Inorganic Content

Inorganic elemental analysis of the smoke particles collected at the fire events revealed that aluminum, iron, magnesium, potassium, and calcium were found for all of the fires. Note that these elements are also the most prevalent in the earth’s crust<sup>1</sup>. Strontium and titanium were only found in smoke particles collected for the master bedroom and kitchen. Copper, lead, antimony, and zinc were only found in smoke particles collected for the study/small bedroom & bathroom fires in which exposed plumbing was involved; manganese was only found in the smoke particles collected for the master bedroom fire. None of the other elements were found at quantifiable limits in any of the collected samples.

Inorganic elemental concentrations measured for the four size ranges (0.52 to 0.93, 0.93 to 3.5, 3.5 to 9.8, and greater than 9.8 microns) are overlaid in Figure 5-21. Concentrations typically ranged between 0.002 and 0.1 mg/m<sup>3</sup> with the aluminum, calcium and magnesium from the master bedroom and child’s bedroom ranging up to 2 mg/m<sup>3</sup>. Inorganic elements were generally found in larger smoke particles more often and in greater concentrations than in the corresponding smaller particle size fractions, for example aluminum was found in all of the collected samples of smoke particles greater than 9.8 microns but in only 3 of 4 fires for smoke

<sup>1</sup> The most common elements present in the earth’s crust are oxygen (46.6%), silicon (27.7%), aluminum (8.1%), iron (5.0%), calcium (3.6%), sodium (2.8%), potassium (2.6%), magnesium (2.1%). Source: “Windows to the Universe”, University Corporation for Atmospheric Research.

particles between 3.5 and 9.8 microns in size and in only 1 of 4 fires for particles smaller 3.5 micron particles. Iron and potassium were found to differ from this trend such that there does not appear to be a clear particle size influence on the number of fires in which these elements were found. Antimony, copper, and lead were only found in smoke particles measuring between 0.93 to 3.5 microns in size.

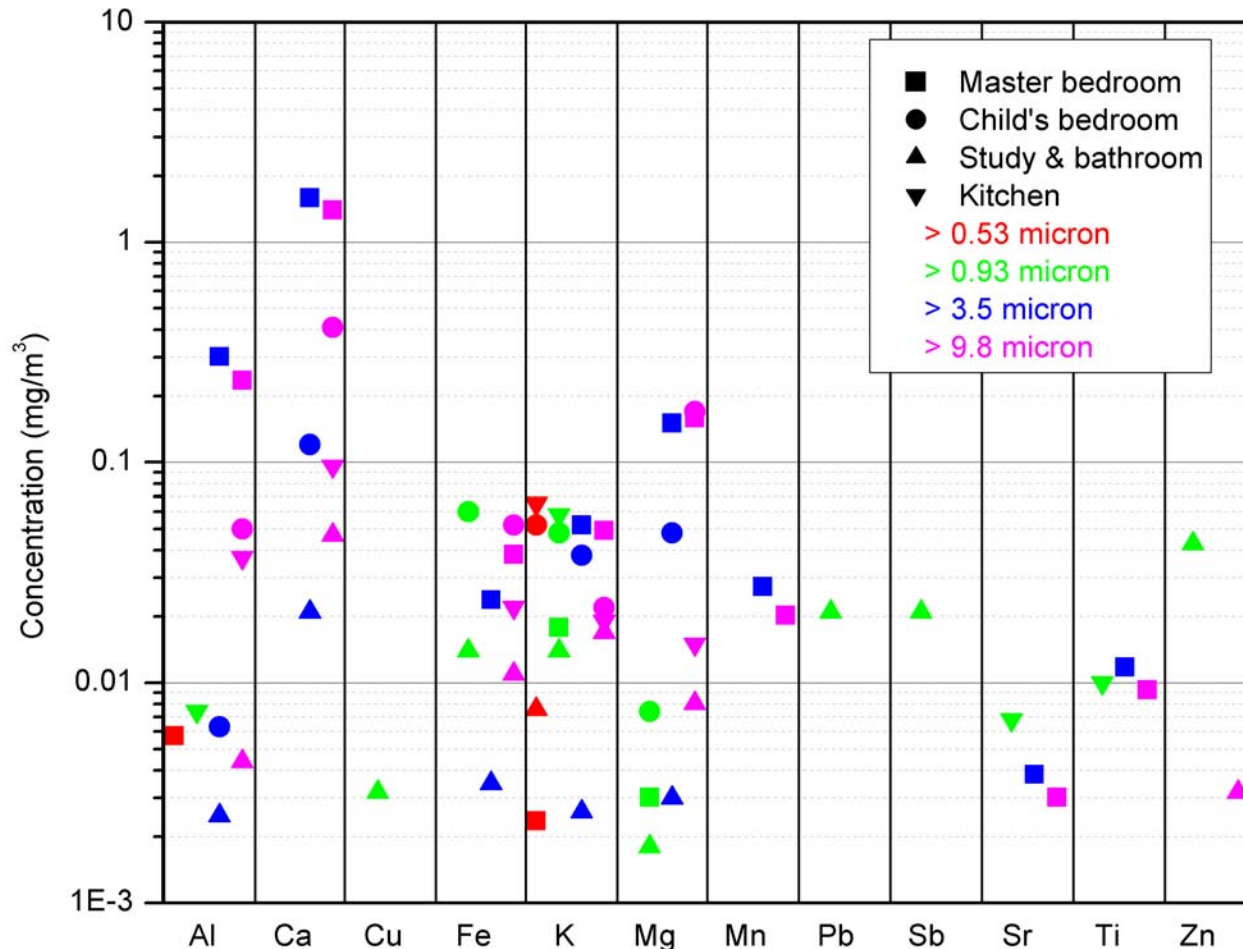


Figure 5-21: ICP elemental analysis of smoke particles from controlled field event fires.

Closer examination of the inorganic elemental results as a function of particle size and fire event indicates that the less robust master bedroom fire usually resulted in greater concentrations than the more intense flashover fires. This is most likely due to greater soot formation observed for less robust fires.

Comparison of NIOSH and OSHA exposure limits to the measured inorganic element concentrations, Table 5-2, indicates that eight-hour time weighted average (TWA) exposures were not exceeded at any fire when assuming there was no additional exposure beyond that of the fire scene for the balance of the eight hour period. Short-term exposures calculated assuming all of the measured concentrations were accumulated during a 15 minute window did not exceed NIOSH STEL at any of the fires. NIOSH IDLH concentrations are also presented in Table 5-2

for the reader's reference despite limitations of the utilized collection method that prohibit direct comparison.

**Table 5-2: Number of controlled field fires in which inorganic element concentrations exceeded various recommended exposure limits.**

| Element          | NIOSH TWA <sup>[1]</sup><br>(mg/m <sup>3</sup> ) | No. of Fires<br>Exceeding<br>TWA | NIOSH STEL<br>(mg/m <sup>3</sup> ) | No. of Fires<br>Exceeding<br>STEL | NIOSH IDLH<br>(mg/m <sup>3</sup> ) |
|------------------|--|----------------------------------|------------------------------------|-----------------------------------|------------------------------------|
| Aluminum (Al)    | 5 <sup>[2]</sup>                                 | 0                                |                                    |                                   |                                    |
| Antimony (Sb)    | 0.5  | 0                                |                                    |                                   | 50                                 |
| Copper (Cu) dust | 1  | 0                                |                                    |                                   | 100                                |
| Iron oxide (FeO) | 5  | 0                                |                                    |                                   | 2,500                              |
| Lead (Pb)        | 0.05   | 0                                |                                    |                                   | 100                                |
| Manganese (Mn)   | 1  | 0                                | 3                                  | 0                                 | 500                                |

Notes: <sup>[1]</sup> Where possible NIOSH limits are used as they are more conservative than OSHA limits  
<sup>[2]</sup> Respirable

#### 5.4.4 Effluent Gas Composition

Measurement of the effluent gas composition in the escaping smoke plumes by OP-FTIR was challenging. Changing fire conditions coupled with shifting winds resulted in erratic smoke plume movement relative to the narrow OP-FTIR beam path. Better results were obtained when operating in active mode than passive mode due to the lack of sufficient thermal (IR) contrast between the venting effluent gases and background. Consequently recorded OP-FTIR results could only be used qualitatively to identify gas species present and their relative concentrations.

Classic combustion products water vapor, carbon dioxide and carbon monoxide were observed in the smoke plume from every fire. Small molecule hydrocarbons, methane, acetylene and ethylene resulting from incomplete combustion were also observed in each fire, Table 5-3. Partially oxidized methane, i.e. methanol, was also observed in the smoke plumes from the study/small bedroom and kitchen fires. Considering the similarities in the room contents for the study/small bedroom and the child's bedroom and the respective fire sizes, it would not be unreasonable to expect methanol in the smoke plume from the child's bedroom fire. The lack of methanol detected was most likely due to the previously described measurement challenges. Beyond water vapor and carbon dioxide, carbon monoxide was observed at the greatest relative concentration in each of the investigated fires at typically 5 to 10 times that of other gases.

**Table 5-3: Effluent gases observed by OP-FTIR.**

| Fire Event          | Gases Observed   |
|---------------------|--|
| Study/small bedroom | H <sub>2</sub> O, CO <sub>2</sub> , CO, CH <sub>4</sub> , C <sub>2</sub> H <sub>4</sub> , C <sub>2</sub> H <sub>2</sub> , CH <sub>3</sub> OH |
| Kitchen             | H <sub>2</sub> O, CO <sub>2</sub> , CO, CH <sub>4</sub> , C <sub>2</sub> H <sub>4</sub> , C <sub>2</sub> H <sub>2</sub> , CH <sub>3</sub> OH |
| Child's bedroom     | H <sub>2</sub> O, CO <sub>2</sub> , CO, CH <sub>4</sub> , C <sub>2</sub> H <sub>4</sub> , C <sub>2</sub> H <sub>2</sub>                      |

## CHAPTER 6: FIELD EVENTS

### 6.0 INTRODUCTION

Firefighter exposure during the course of normal fire response was characterized to assess the potential threat of combustion gases and airborne smoke particulates in the firefighter's personal proximity. Smoke deposition and soot accumulation on firefighter gloves and hoods were characterized to better understand the exposure risk of contaminated protective clothing.

### 6.1 FIRE EVENTS

Smoke exposure was monitored at forty-four fires responded to by the Chicago Fire Department over a four month period beginning in February 2009. The responded to fires, listed in Table 6-1, included forty residential structures and four commercial buildings. Firefighter activities monitored during the course of normal firefighting operations included suppression, ventilation, search & rescue, and overhaul, Table 6-1. The selected firefighters were working members of Rescue Squad Company Number 5. Rescue Squad 5 annually is the most active of the four Rescue Squad companies within the City of Chicago averaging more than 1,500 fires responses annually.

#### 6.1.1 Personal Air Sampling

Two teams of two firefighters were trained in the use of direct reading gas analyzers (described in Section 2.4) and personal cascade impactors (described in Section 2.5). These firefighter teams worked rotating 24 hr shifts and were assigned to a single fire station. All of the personal air sampling equipment was staged with the participating firefighters for use during their normal course of operations.

Personal gas monitors and cascade impactors were used at 14 and 11 fires respectively as indicated in Table 6-1. Collected smoke samples were analyzed for inorganic element content as described in Section 6.2.3.

#### 6.1.2 Gloves and Hoods

Standard CFD issue leather gloves and CarbonX® hoods were distributed to eight firefighters for use during their normal course of operations. These firefighters worked a rotating 24 hour on and 48 hour off shift schedule with every fifth scheduled work day off and were assigned to a single fire station. The fires at which each glove and hood was used is identified in Table 6-2 and the descriptions of the fires and the corresponding firefighter activities are summarized Table 6-1. Two sets of gloves and hoods were collected from the participating firefighters every two weeks to characterize the inorganic elemental and organic compound content accumulated over 2, 4, 6, and 8 weeks of usage as identified in Table 6-2. The collected gloves and hoods were analyzed for inorganic element and organic compound content as described in Sections 6.2.4 through 6.2.6.

**Table 6-1: Description of fire events responded to and measurements employed.**

| Fire No. | Description of Fire Event and Firefighter Activity  |   | No. of Measurements |                |              |
|----------|---|---|---------------------|----------------|--------------|
|          | Fire Event  | Firefighter Activity  | Gas                 | Smoke Particle | Glove & Hood |
| 1        | 2-story ordinary – fire in kitchen with extension to rear porches                                 | Conducted searches, ventilation and overhaul.   | -                   | -              | 2            |
| 2        | 2 1/2-story frame – fire on the top floor   | Conducted forcible entry, search and overhaul.  | -                   | -              | 2            |
| 3        | 1 1/2-story frame   | Searched both floors and performed overhaul. Limited visibility.  | -                   | -              | 1            |
| 4        | 2-story ordinary, rowhouse  | Searched both floors and performed overhaul. Limited visibility.  | -                   | -              | 2            |
| 5        | 2-story ordinary – fire in the 1 <sup>st</sup> floor storefront                                   | Checked exposure for extension then performed overhaul in fire building.  | -                   | -              | 1            |
| 6        | 2-story ordinary – fire on rear porches   | Conducted overhaul.   | -                   | -              | 1            |
| 7        | 1 1/2-story frame – fire in the basement  | Ventilation, search, hose line advancement and a little overhaul.   | -                   | -              | 1            |
| 8        | 1 1/2-story frame – fire on the rear porch with extension to the 2 <sup>nd</sup> floor            | Threw ladders, ventilated, searched and performed overhaul.   | -                   | -              | 4            |
| 9        | 1 1/2-story frame   | Fire out on arrival, ventilation well underway. Assisted with final search and some overhaul on 1 <sup>st</sup> floor. Visibility was good. | 2                   | 2              | 1            |
| 10       | 1 1/2-story frame – fire in the attic bedroom   | Performed search and overhaul of fire room.   | 2                   | 2              | 1            |
| 11       | 3-story ordinary – heavy fire on all 3 floors   | Fire attack on 1 <sup>st</sup> floor then exterior attack from Snorkel bucket.  | -                   | -              | 1            |
| 12       | 1 story noncombustible strip mall – fire in exterior signage                                      | Pulled soffit to expose fire.   | -                   | -              | 1            |
| 13       | 2-story ordinary – fire on both floors  | Assisted with fire attack, searches, and extensive overhaul on both floors.   | -                   | -              | 1            |
| 14       | 2 1/2- story frame – fire throughout the structure  | Searched both floors and performed overhaul. Limited visibility.  | -                   | -              | 3            |
| 15       | 3-story ordinary – fire on 1 <sup>st</sup> floor  | Searched 1 <sup>st</sup> and 2 <sup>nd</sup> floors and performed overhaul. Limited visibility.   | -                   | -              | 1            |
| 16       | 1 1/2-story frame – fire in basement  | Conducted overhaul on 1 <sup>st</sup> floor.  | -                   | -              | 1            |
| 17       | 2 1/2- story frame – fire started on back porch and extended into 2 <sup>nd</sup> floor and attic | Conducted search and rescue, salvage and overhaul.  | -                   | -              | 1            |
| 18       | 2 1/2-story frame – heavy fire in the rear of the structure                                       | Assisted with fire attack and performed extensive overhaul.   | -                   | -              | 2            |
| 19       | 3-story ordinary – fire on the 2 <sup>nd</sup> floor  | Conducted overhaul in 2 <sup>nd</sup> floor bedroom. Limited visibility.  | -                   | -              | 1            |
| 20       | 2-story ordinary – fire in basement and 1 <sup>st</sup> floor                                     | Searched 1st floor in limited visibility and conducted overhaul.  | -                   | -              | 1            |
| 21       | 1-story noncombustible commercial   | Performed forcible entry and overhaul.  | -                   | -              | 1            |



Table 6-1 CONTINUED

|    |   |   |   |   |   |
|----|---|---|---|---|---|
| 22 | 2-story ordinary – fire on 1 <sup>st</sup> floor  | Performed overhaul.   | - | - | 1 |
| 23 | 1 1/2-story frame – fire in the basement with extension to the 1 <sup>st</sup> floor                            | Searched 2 <sup>nd</sup> floor and overhauled all three levels.   | - | - | 1 |
| 24 | 1-story noncombustible warehouse  | Fire out on arrival; smoke bottled up. Assisted with secondary search, extension of fire, vent, overhaul, searched basement.  | 1 | 2 | - |
| 25 | 2 1/2-story frame – fire on 1 <sup>st</sup> and 2 <sup>nd</sup> floors  | Assisted with overhaul.   | - | - | 3 |
| 26 | 2-story ordinary – fire in heating closet on 2 <sup>nd</sup> floor  | Conducted overhaul.   | - | - | 2 |
| 27 | 2-story frame – fire on 1 <sup>st</sup> and 2 <sup>nd</sup> floors  | Conducted overhaul.   | - | - | 2 |
| 28 | 2-story ordinary – fire on 1 <sup>st</sup> and 2 <sup>nd</sup> floors   | Limited visibility, conducted overhaul.   | - | - | 1 |
| 29 | 2-story ordinary  | Assist in advancement of line; stand by on 1 <sup>st</sup> floor until safe to go to 2 <sup>nd</sup> floor with overhaul company; assist with overhaul, vent, and search. | 2 | 2 | - |
| 30 | 1 1/2-story frame – fire in the attic   | Conducted search and overhaul.  | - | - | 3 |
| 31 | 2-story ordinary – fire on 2 <sup>nd</sup> floor  | Limited visibility. Conducted overhaul.   | - | - | 1 |
| 32 | 2 1/2-story frame – electrical fire that started on 1 <sup>st</sup> floor and extended to 2 <sup>nd</sup> floor | Large amount of overhaul.   | - | - | 2 |
| 33 | 2 1/2-story frame - fire in the rear of the 1 <sup>st</sup> and 2 <sup>nd</sup> floors                          | Assisted with fire attack, searched and performed overhaul on 2 <sup>nd</sup> floor.  | 2 | 2 | 1 |
| 34 | 2-story frame – fire in the attic   | Conducted overhaul.   | - | - | 1 |
| 35 | 1 1/2-story frame – fire in the rear  | Performed secondary search.   | 2 | 2 | - |
| 36 | 2-story ordinary – fire in the basement   | Conducted overhaul.   | 2 | - | - |
| 37 | 2 1/2-story frame – fire in the rear porch  | Assisted 1 <sup>st</sup> engine with advancing line to rear; forced entry and some overhaul on 2 <sup>nd</sup> floor.   | 2 | 2 | - |
| 38 | 1-story noncombustible gas station  | Assisted with primary and secondary search; minor overhaul.   | 2 | 2 | - |
| 39 | 2-story ordinary – fire on the 1 <sup>st</sup> floor  | Conducted primary and secondary search on 2 <sup>nd</sup> floor; vent and overhaul on 1 <sup>st</sup> and 2 <sup>nd</sup> floor.  | 2 | 2 | - |
| 40 | 1-story ordinary – fire on the 1 <sup>st</sup> floor  | Performed ventilation, secondary, and final search.   | 2 | - | - |
| 41 | 3-story ordinary, residential above commercial – fire on 2 <sup>nd</sup> and third floors                       | Secondary search on 3 <sup>rd</sup> floor; advanced line, overhaul, and washdown on 3 <sup>rd</sup> floor.  | 2 | - | - |

**Table 6-1 CONTINUED**

|    |  |  |   |   |   |
|----|--|--|---|---|---|
| 42 | 3-story ordinary, multifamily apartment bldg                                     | Primary search on 2 <sup>nd</sup> and 3 <sup>rd</sup> floor, secondary on 3 <sup>rd</sup> floor.                                       | - | 2 | - |
| 43 | 1 1/2-story frame – fire on the 1 <sup>st</sup> floor in the front room          | Assisted with advancing interior attack line; primary search of 1 <sup>st</sup> floor; horizontal ventilation; overhaul in front room. | 1 | 2 | - |
| 44 | 3-story ordinary, multifamily apartment bldg – fire on the 3 <sup>rd</sup> floor | Assisted with line to apt; secondary search and minor vent/overhaul.   | 2 | - | - |

**Table 6-2: Identification of fire events at which gloves and hoods were exposed.**

| Firefighter | Weeks used | Number of Fires | Fire No. (Table 6-1)              |
|-------------|------------|-----------------|-----------------------------------|
| T1a         | 2          | 4               | 1,2,5,7                           |
| T1b         | 2          | 3               | 1,2,8                             |
| T2a         | 4          | 5               | 6,18,21,23,30                     |
| T2b         | 4          | 6               | 9,10,11,18,30,32                  |
| T3a         | 6          | 4               | 8,13,14,25                        |
| T3b         | 6          | 7               | 3,4,8,14,16,26,27                 |
| T4a         | 8          | 13              | 4,8,14,15,19,20,22,25,26-28,31,34 |
| T4b         | 8          | 5               | 12,17,30,32,33                    |

## 6.2 EXPERIMENTAL

### 6.2.1 Personal Air Sampling – Gas

Firefighters were outfitted with 6-gas direct-reading personal gas monitors as described in Section 2.4. Monitors were calibrated at the beginning of each shift. Personal air monitoring was initiated at the fire scene prior to structure entry and operated until structure exit.

### 6.2.2 Personal Air Sampling – Smoke Particle Size Distribution

Airborne smoke particles in the firefighter's personal area were collected using the four-stage personal cascade impactor described in Section 2.5. Sampling was initiated at the fire scene prior to structure entry and operated until structure exit. Each cut plate and the final filter from the used impactor was gravimetrically analyzed to determine the mass distribution of the collected particle sizes.

### 6.2.3 Personal Air Sampling – Smoke Particle Inorganic Content

Smoke particles collected on the different impactor cut plates were analyzed by inductively coupled plasma/mass spectroscopy (ICP/MS) for their inorganic element content (ICP-MS is described in Section 2.7). Phosphorus (P) concentration was measured using a modified NIOSH 7300 protocol, arsenic (As) concentration using a modified NIOSH 7303 protocol, and a modified OSHA ID-125G protocol was used to measure aluminum (Al), antimony (Sb), barium (Ba), beryllium (Be), cadmium (Cd), calcium (Ca), chromium (Cr), cobalt (Co), copper (Cu), iron (Fe), lead in air (Pb), lithium (Li), magnesium (Mg), manganese (Mn), molybdenum (Mo), nickel (Ni), potassium (K), selenium (Se), silver (Ag), sodium (Na), strontium (Sr), thallium (Tl), tin (Sn), titanium (Ti), vanadium (V), and zinc (Zn) concentrations.

#### 6.2.4 Hood and Glove – Inorganic Content

The inorganic elemental content of the combustion products accumulated on the gloves and hoods were determined by ICP-MS (Section 2.7). Test specimens were prepared by cutting *ca.* 1.0 g sections from the glove palms and the back neck portion of the hoods, immersing them in 40 mL of aqua regia and sonicating for 30 minutes. Unexposed glove and hood specimens were similarly prepared for reference purposes.

Filtered aliquots of the prepared specimen were diluted with reagent water by a factor 10 prior to analysis. Where measured aluminum, boron, chromium, lead, strontium, and zinc concentrations exceeded the upper limits of the calibration curves, samples were further diluted with 1% HNO<sub>3</sub>. Minimum reported limits (MRL) were adjusted according to the dilution factors applied to the samples.

Samples were analyzed for aluminum (Al), antimony (Sb), arsenic (As), silver (Ag), boron (B), barium (Ba), beryllium (Be), cadmium (Cd), chromium (Cr), cobalt (Co), copper (Cu), lithium (Li), manganese (Mn), molybdenum (Mo), nickel (Ni), lead (Pb), selenium (Se), strontium (Sr), tin (Sn), thallium (Tl), thorium (Th), titanium (Ti), uranium (U), vanadium (V), and zinc (Zn).

#### 6.2.5 Hood and Glove – Mercury Content

The mercury content of the unexposed and collected gloves and hoods was determined by cold vapor atomic absorption spectroscopy, EPA Method 245.1, using the samples prepared for the inorganic content analysis (Section 6.2.4). Where required, samples were further diluted to maintain measured concentrations within the less than 2.0 µg/L calibration concentration range.

#### 6.2.6 Hood and Glove – Organic Content

The polynuclear aromatic hydrocarbons (PAHs) and other organic constituents of the combustion products accumulated on the gloves and hoods were determined by GC-MS (Section 2.8). Test specimens were prepared by cutting *ca.* 1.0 g sections from the glove palms and the back neck portion of the hoods, immersing them in 40 mL of methylene chloride and sonicating for 30 minutes. Unexposed glove and hood specimens were similarly prepared for reference purposes.

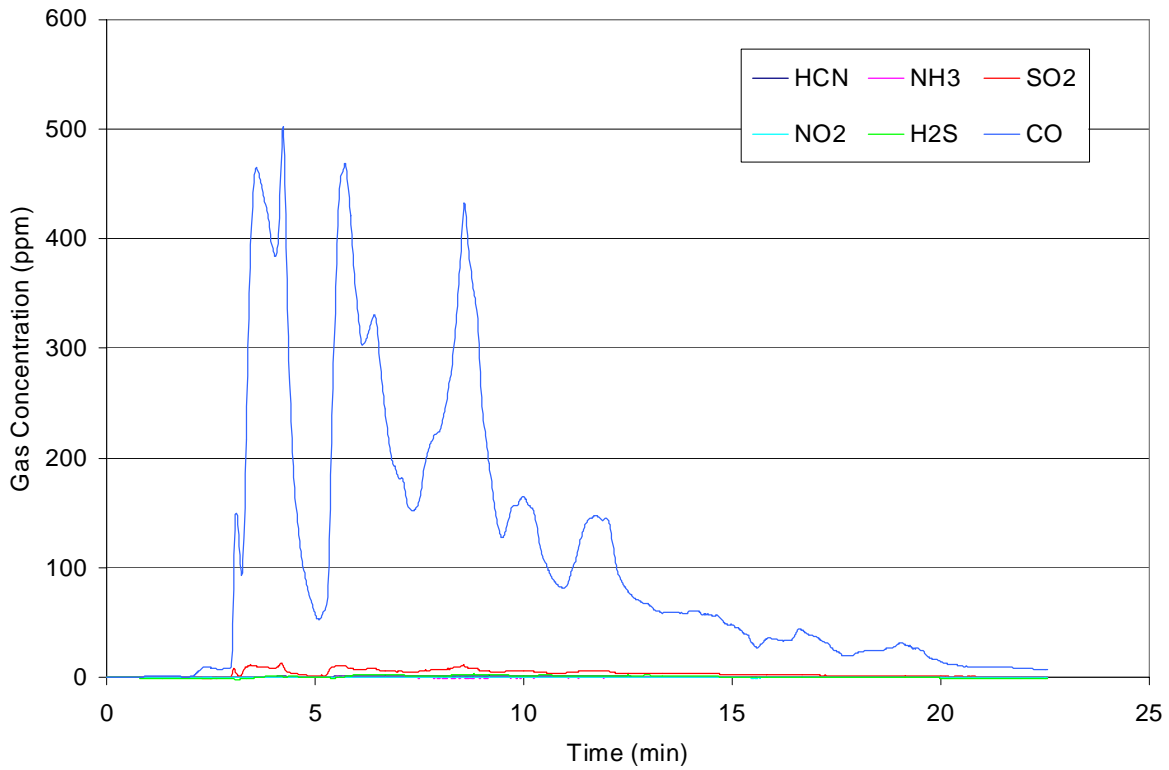
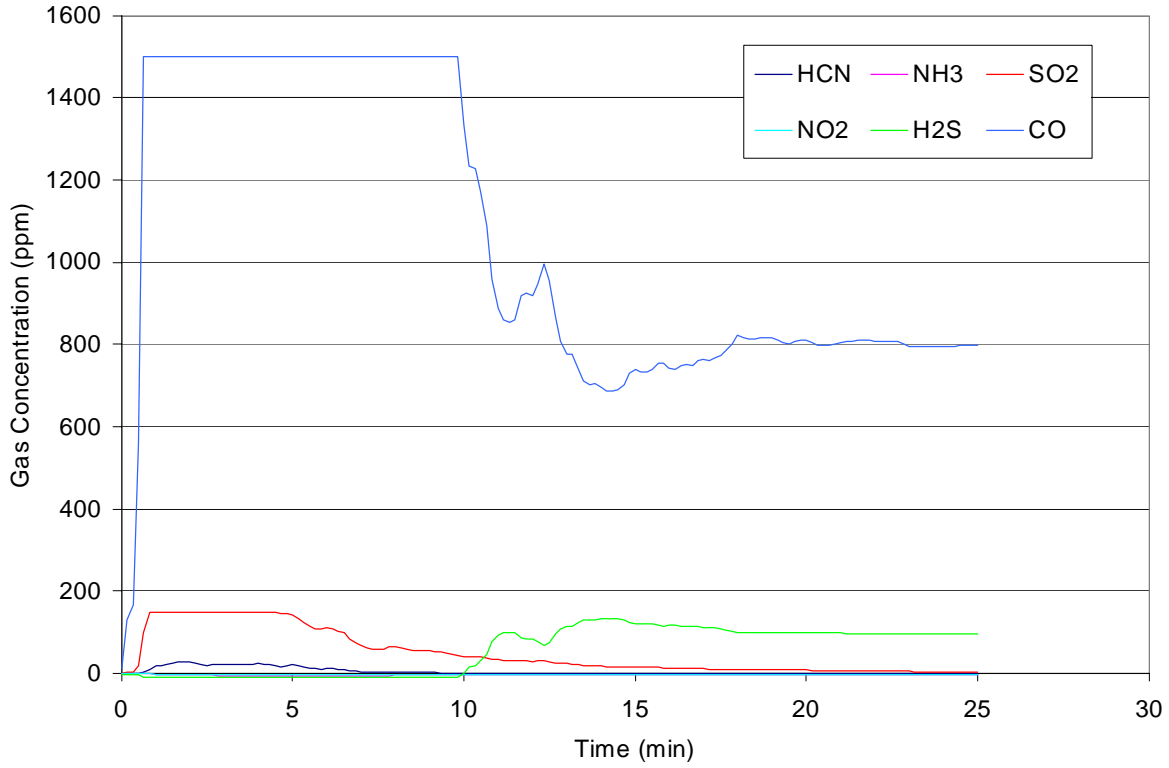
Samples were analyzed for naphthalene, 2-methylnaphthalene, acenaphthylene, acenaphthene, fluorene, phenanthrene, anthracene, fluoranthrene, pyrene, benzo[a]anthracene, chrysene, benzo[b]fluoranthracene, benzo[k]fluoranthracene, benzo[a]pyrene, indeno[1,2,3,cd]pyrene, dibenz[a,h]anthracene, benzo[g,h,i]perylene, acetophenone, di-n-butylphthalate, butylbenzylphthalate, di-2-ethylhexyladipate, di-2-ethylhexylphthalate, di-n-octyl phthalate, phenol, 2-methylphenol, 4-methylphenol, 2,4-dimethylphenol, and 4-chloro-3-methylphenol.

## 6.3 RESULTS

### 6.3.1 Personal Air Sampling – Gas

Concentrations of gases in the firefighters' personal areas were measured using direct reading gas monitors worn at fourteen fires by the outfitted teams. During the course of the study period, one of the monitoring units was inadvertently deactivated during fire #24 and no data was collected, only the carbon monoxide sensor was calibrated by the time the response call was received for fire #41, one unit was not calibrated by the time the response call for fire #43 was received and therefore was not used, and the sulfur dioxide sensors failed in both units used at the final monitored fire, #44.

Concentrations of the monitored gases were found to vary tremendously from fire to fire. Examples of gas concentration readings from two fires are plotted in Figure 6-1. It was notable that concentrations of the various gases, most clearly observable for carbon monoxide, vary depending on the activity being performed by the firefighter. For the example depicted in Figure 6-1 top, a fire on the 1<sup>st</sup> floor of a 2-story ordinary structure (#39), the firefighter turned the gas monitor unit on outside of the structure, entered the structure, conducted primary and secondary search on the 2<sup>nd</sup> floor, then conducted vent and overhaul activities on both the 1<sup>st</sup> and 2<sup>nd</sup> floors. Overhaul was completed approximately 22:40 minutes after monitoring started, at which point the firefighter exited the structure and terminated gas monitoring. During the course of these activities the firefighter noted heavy smoke conditions upon entry, a reduction in smoke density to moderately heavy levels approximately eight minutes later, and further reduction in smoke density approximately three and a half minutes later (*ca.* 11:30 minutes after monitoring was started). Firefighter activity for the bottom example in Figure 6-1, involving a fire on the rear side of a 2½-story frame structure (#33), included assisting with the fire attack from the building exterior, followed by search and overhaul on the 2<sup>nd</sup> floor.



**Figure 6-1: Examples of personal gas monitor data. Note how the carbon monoxide and sulfur dioxide sensors saturated during the fire presented in the top figure.**

Descriptive statistics (minimum, maximum, 1<sup>st</sup> and 3<sup>rd</sup> quartile, median and mean values) of peak concentrations and total exposures for the six gases in all of the monitored fires are captured in Table 6-3 and Table 6-4 respectively. Hydrogen cyanide, hydrogen sulfide, and carbon monoxide were observed at every fire by both monitored responders; sulfur dioxide and nitrogen dioxide were detected at every fire but not always by both monitored responders. Ammonia was not detected at every fire.

**Table 6-3: Descriptive statistics for peak gas concentrations measured at fire events.**

| Gas              | Number of samples | Peak Concentration (ppm) |     |        |       |                      |                     |
|------------------|-------------------|--------------------------|-----|--------|-------|----------------------|---------------------|
|                  |                   | Minimum                  | Q1  | Median | Q3    | Maximum              | Mean                |
| HCN              | 25                | 0.1                      | 1.3 | 2.4    | 10.4  | 30.0                 | 7.0                 |
| NH <sub>3</sub>  | 25                | 0.0                      | 0.0 | 0.0    | 1.5   | 4.0                  | 0.8                 |
| SO <sub>2</sub>  | 22                | 0.0                      | 7.7 | 15.9   | 30.9  | 150.0 <sup>[1]</sup> | 29.6 <sup>[1]</sup> |
| NO <sub>2</sub>  | 25                | 0.0                      | 0.3 | 0.4    | 0.9   | 2.3                  | 0.7                 |
| H <sub>2</sub> S | 25                | 0.9                      | 3.4 | 5.8    | 8.0   | 133.9                | 18.4                |
| CO               | 26                | 59                       | 295 | 680    | 1,189 | 1,500 <sup>[1]</sup> | 774 <sup>[1]</sup>  |

Note: <sup>[1]</sup> Listed maximum and mean peak concentrations include sensor-limited values for the fires in which limits were exceeded. True values should be higher.

The collected data were in reasonable agreement with mean and maximum concentrations reported by Burgess<sup>1</sup> for firefighters in the Tucson area (0.14-5.0 ppm and 75 ppm for hydrogen cyanide, 0.04-0.7 ppm and 9.5 ppm for nitrogen dioxide, 2.3 and 42 ppm for sulfur dioxide, 246-1,450 ppm and 27,000 ppm for carbon monoxide).

**Table 6-4: Descriptive statistics for total gas exposure measured at fire events.**

| Gas              | Number of samples | Total Exposure (ppm-minutes) |       |        |       |                        |                      |
|------------------|-------------------|------------------------------|-------|--------|-------|------------------------|----------------------|
|                  |                   | Minimum                      | Q1    | Median | Q3    | Maximum                | Mean                 |
| HCN              | 25                | 0.1                          | 7.7   | 16.3   | 37.2  | 130.1                  | 27.4                 |
| NH <sub>3</sub>  | 25                | 0.0                          | 0.0   | 0.0    | 17.3  | 62.0                   | 8.6                  |
| SO <sub>2</sub>  | 22                | 0.0                          | 61.2  | 118.7  | 164.6 | 1,263.4 <sup>[1]</sup> | 200.2 <sup>[1]</sup> |
| NO <sub>2</sub>  | 25                | 0.0                          | 0.2   | 0.6    | 1.3   | 4.9                    | 0.9                  |
| H <sub>2</sub> S | 25                | 2.8                          | 15.9  | 21.5   | 48.7  | 1,528.9                | 146.2                |
| CO               | 26                | 356                          | 1,592 | 2,666  | 5,740 | 29,731 <sup>[1]</sup>  | 5,313 <sup>[1]</sup> |

Note: <sup>[1]</sup> Listed maximum and mean total exposures include sensor-limited values for the fires in which limits were exceeded. True values should be higher.

The previous data provides a gross estimate of potential average exposure threat from a given fire. This information is useful for estimating the total potential exposure over the course of time, for instance the total potential exposure over a year could be calculated by multiplying the number of fires responded to by the mean values in Table 6-4.

Because not every gas was found at each fire, descriptive statistics (minimum, maximum, 1<sup>st</sup> and 3<sup>rd</sup> quartile, median and mean values) summarized in Table 6-5 and plotted in Figure 6-2 reflect the peak gas concentrations for *only* the fires in which they were detected rather than across all monitored fires. Similarly descriptive statistics (minimum, maximum, 1<sup>st</sup> and 3<sup>rd</sup> quartile, median

<sup>1</sup> J Burgess and C Crutchfield, "Tucson Fire Fighter Exposure to Products of Combustion: A Risk Assessment", Appl. Occup. Environ. Hyg., vol. 10, issue 1, pp. 37, January 1995.

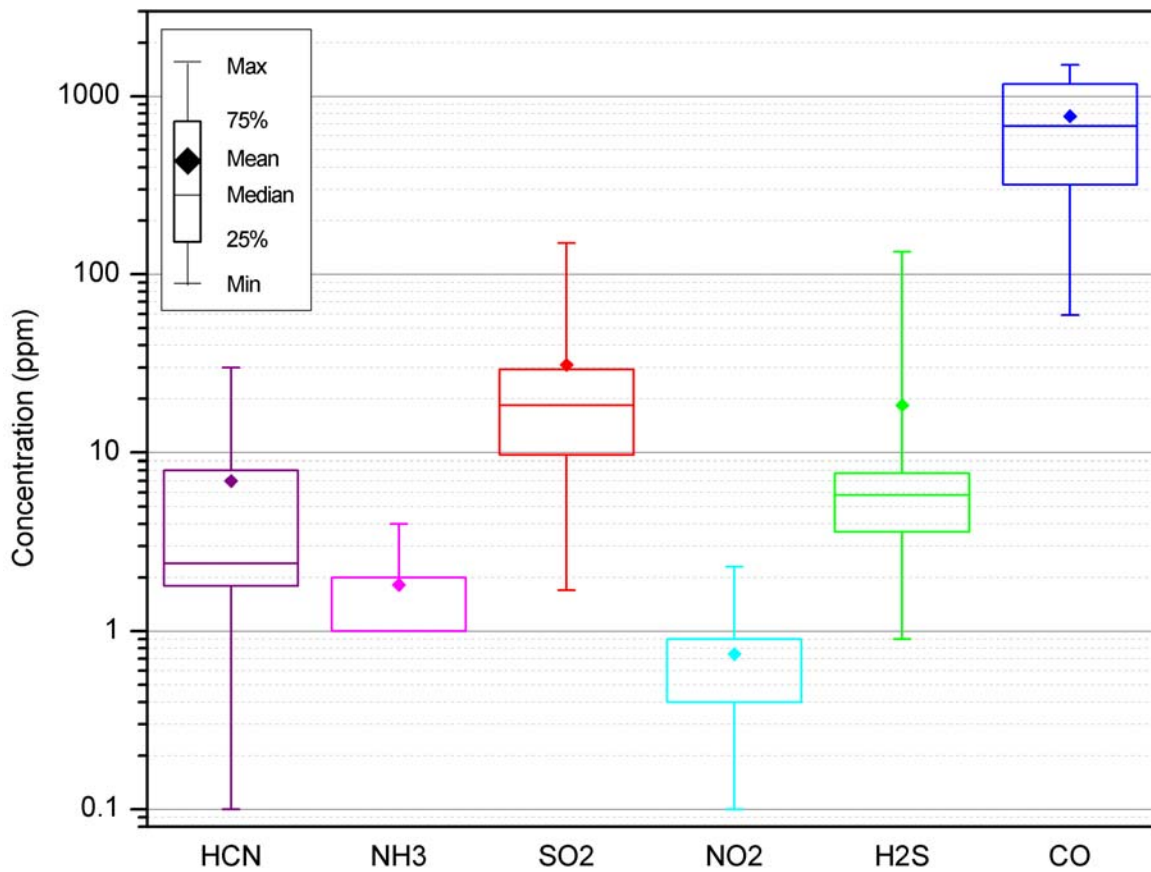
and mean values) summarized in Table 6-6 and plotted in Figure 6-3 reflect total gas exposures for *only* the fires in which they were detected rather than across all fires monitored. This information is more useful for estimating the potential exposure threat that firefighters may be exposed to at a given fire.

**Table 6-5: Descriptive statistics for peak gas concentrations measured at fire events.**

| Gas              | Number of samples <sup>[1]</sup> | Peak Concentration (ppm) |     |        |       |                      |                     |
|------------------|----------------------------------|--------------------------|-----|--------|-------|----------------------|---------------------|
|                  |                                  | Minimum                  | Q1  | Median | Q3    | Maximum              | Mean                |
| HCN              | 25                               | 0.1                      | 1.3 | 2.4    | 10.4  | 30.0                 | 7.0                 |
| NH <sub>3</sub>  | 11                               | 1.0                      | 1.0 | 2.0    | 2.0   | 4.0                  | 1.8                 |
| SO <sub>2</sub>  | 21                               | 1.7                      | 9.1 | 18.4   | 32.6  | 150.0 <sup>[2]</sup> | 31.0 <sup>[2]</sup> |
| NO <sub>2</sub>  | 23                               | 0.1                      | 0.4 | 0.4    | 0.9   | 2.3                  | 0.7                 |
| H <sub>2</sub> S | 25                               | 0.9                      | 3.4 | 5.8    | 8.0   | 133.9                | 18.4                |
| CO               | 26                               | 59                       | 295 | 680    | 1,189 | 1,500 <sup>[2]</sup> | 774 <sup>[2]</sup>  |

Note: <sup>[1]</sup> Number of samples is limited to responder recordings in which the particular gas species was observed.

<sup>[2]</sup> Listed maximum and mean peak concentrations include sensor-limited values for the fires in which limits were exceeded. True values should be higher.



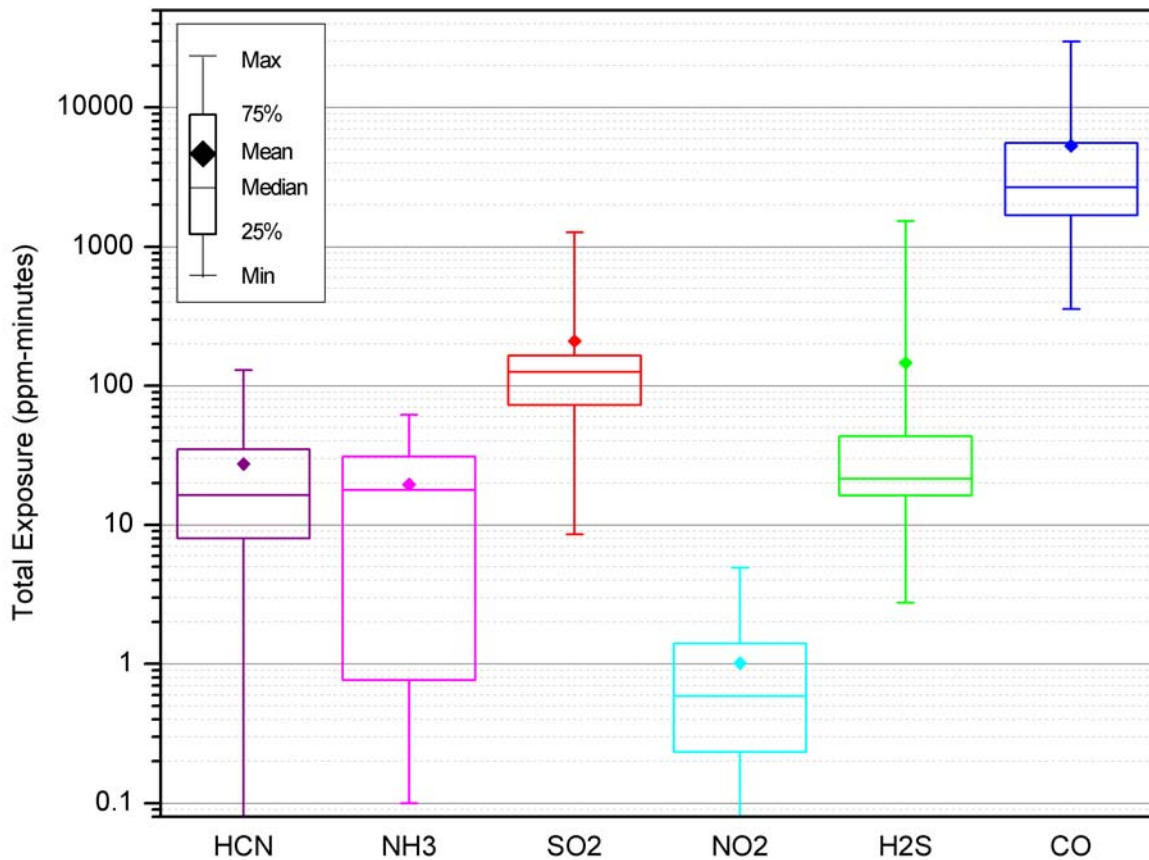
**Figure 6-2: Peak gas concentrations measured at fire events.**

**Table 6-6: Descriptive statistics for total gas exposure measured at fire events.**

| Gas              | Number of samples <sup>[1]</sup> | Total Exposure (ppm-minutes) |       |        |       |                        |                      |
|------------------|----------------------------------|------------------------------|-------|--------|-------|------------------------|----------------------|
|                  |                                  | Minimum                      | Q1    | Median | Q3    | Maximum                | Mean                 |
| HCN              | 25                               | 0.1                          | 7.7   | 16.3   | 37.2  | 130.1                  | 27.4                 |
| NH <sub>3</sub>  | 11                               | 0.1                          | 0.8   | 17.8   | 31.0  | 62.0                   | 19.5                 |
| SO <sub>2</sub>  | 21                               | 8.6                          | 69.8  | 125.3  | 164.7 | 1,263.4 <sup>[2]</sup> | 209.7 <sup>[2]</sup> |
| NO <sub>2</sub>  | 23                               | 0.0                          | 0.2   | 0.6    | 1.4   | 4.9                    | 1.0                  |
| H <sub>2</sub> S | 25                               | 2.8                          | 15.9  | 21.5   | 48.7  | 1,528.9                | 146.2                |
| CO               | 26                               | 356                          | 1,592 | 2,666  | 5,740 | 29,731 <sup>[2]</sup>  | 5,313 <sup>[2]</sup> |

Note: <sup>[1]</sup> Number of samples is limited to responder recordings in which the particular gas species was observed.

<sup>[2]</sup> Listed maximum and mean total exposures include sensor-limited values for the fires in which limits were exceeded. True values should be higher.



**Figure 6-3: Total gas exposure measured at fire events.**

Comparison of gas concentrations to NIOSH and OSHA exposure limits, Table 6-7, indicate that Immediately Dangerous to Life or Health (IDLH) limits for sulfur dioxide, hydrogen sulfide, and carbon monoxide were exceeded in fire #39 (two-story, two-unit residence fire) and that carbon monoxide IDLH limits were exceeded at three other fires (#10, 36, and 40). Short-term exposure limits (STEL) developed for 10 or 15 minute exposure time frames were exceeded in one fire for hydrogen sulfide (#39), two fires for hydrogen cyanide (#10 and 39), eight fires for sulfur dioxide (#10, 29, 35-40), and nine fires for carbon monoxide (#10, 29, 33, 35-37, 39, 40, and 43). STEL were exceeded by hydrogen cyanide, sulfur dioxide, hydrogen sulfide, and carbon



monoxide in the two-story, two-unit residence fire (#39) in which IDLH limits for sulfur dioxide, hydrogen sulfide, and carbon monoxide were exceeded. Eight hour time weighted average (TWA) exposures were calculated for each fire exposure such that there was zero gas exposure for the balance of the eight hour period, Table 6-7. TWA limits were exceeded for sulfur dioxide and carbon monoxide in the same two-story, two-unit residence fire (#39) in which STEL and IDLH were exceeded.

**Table 6-7: Number of fires in which gas concentrations exceeded various recommended exposure limits.**

| Gas              | NIOSH IDLH (ppm) | No. of Fires Exceeding IDLH | NIOSH STEL (ppm)   | No. of Fires Exceeding STEL | TWA <sup>[2]</sup> (ppm) | No. of Fires Exceeding TWA |
|------------------|------------------|-----------------------------|--------------------|-----------------------------|--------------------------|----------------------------|
| HCN              | 50               | 0                           | 4.7                | 2                           | 10 <sup>[3]</sup>        | 0                          |
| NH <sub>3</sub>  | 300              | 0                           | 35                 | 0                           | 25                       | 0                          |
| SO <sub>2</sub>  | 100              | 1                           | 5                  | 8                           | 2                        | 1                          |
| NO <sub>2</sub>  | 20               | 0                           | 1                  | 0                           | 5 <sup>[3]</sup>         | 0                          |
| H <sub>2</sub> S | 100              | 1                           | 10 <sup>[1]</sup>  | 1                           | 10                       | 0                          |
| CO               | 1,200            | 4                           | 200 <sup>[1]</sup> | 9                           | 35                       | 1                          |

Notes: <sup>[1]</sup> 10 minute exposure limits

<sup>[2]</sup> Where possible NIOSH limits are used as they are more conservative than OSHA limits

<sup>[3]</sup> OSHA limit

As seen in Table 6-7, carbon monoxide concentrations exceeded recommended exposure limits more frequently than the other monitored gases. Despite this greater frequency, carbon monoxide concentrations exceeded recommended limits at the same time as sulfur dioxide (eleven observations) and hydrogen cyanide (two observations). In the two observations in which hydrogen cyanide, carbon monoxide, and sulfur dioxide concentrations exceeded respective recommended exposure limits, both carbon monoxide and sulfur dioxide concentrations exceeded exposure limits prior to hydrogen sulfide. There was however one fire (#38 – gas station) in which sulfur dioxide concentrations exceeded STEL but carbon dioxide did not (short-term carbon monoxide levels were almost an order of magnitude less than the STEL for this fire). This suggests that carbon monoxide monitoring may provide firefighters a first line of gas exposure threat warning but does not provide warning of other gases that may be present in excess of recommended exposure limits.

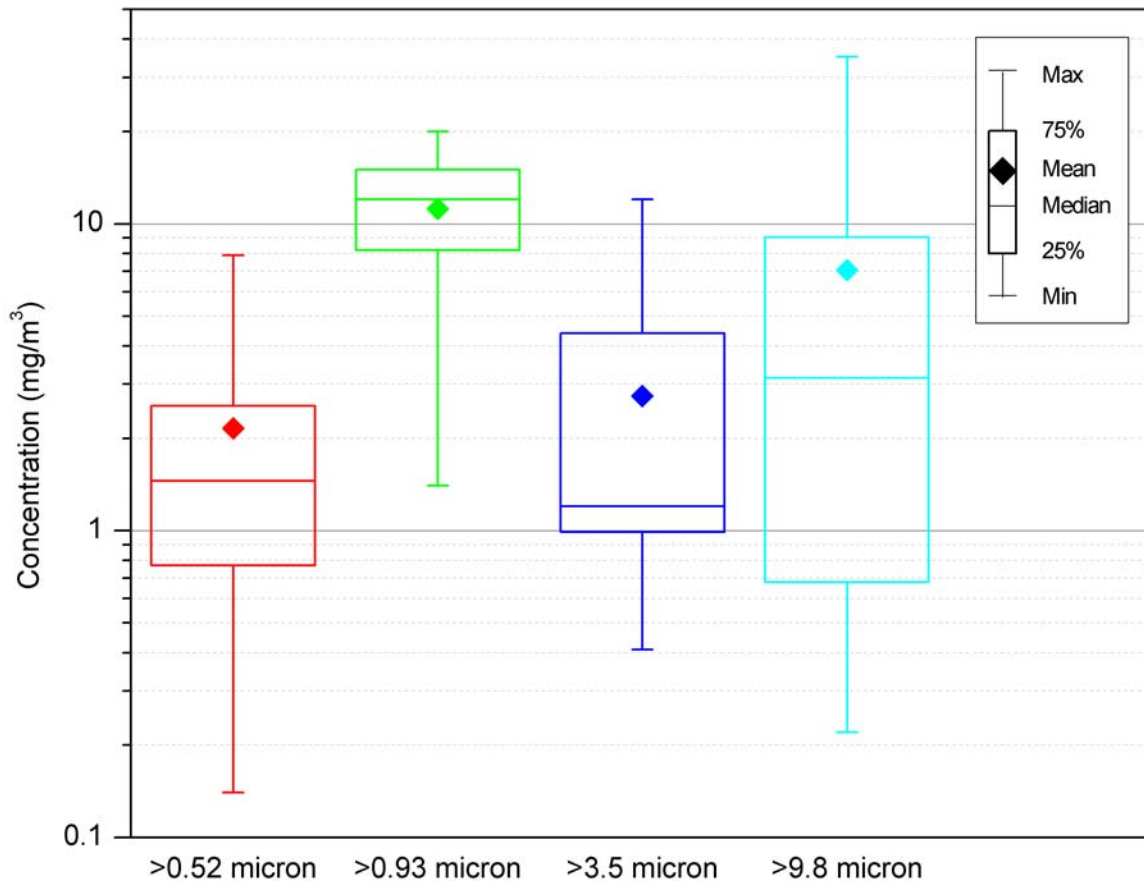
### 6.3.2 Personal Air Sampling – Smoke Particle Size Distribution

Smoke particles in the firefighters' personal areas were collected using personal cascade impactors at eleven fires by the teams of outfitted firefighters. Particles accumulated on the four impactor cut plates (0.52, 0.93, 3.5, 9.8 micron) and the 5 micron glass fiber filter were weighed and corrected for the different collection time periods (*i.e.* flow volumes). As seen in the descriptive statistics (minimum, maximum, 1<sup>st</sup> and 3<sup>rd</sup> quartile, median and mean values) summarized in Table 6-8 and plotted in Figure 6-4, smoke particles ranging between 0.93 and 3.5 microns in diameter comprised the dominant mass fraction of collected particles.

**Table 6-8: Descriptive statistics for flow corrected accumulated smoke particles in personal cascade impactors.**

| Particle Size Range (micron) | Number of samples <sup>[1]</sup> | Smoke Particle Concentration (mg/m <sup>3</sup> ) |      |        |     |         | Mean |
|------------------------------|----------------------------------|---|------|--------|-----|---------|------|
|                              |                                  | Minimum   | Q1   | Median | Q3  | Maximum |      |
| 0.52 – 0.93                  | 12                               | 0.14  | 0.61 | 1.5    | 2.6 | 7.9     | 2.2  |
| 0.93 – 3.5                   | 15                               | 1.4   | 8.2  | 12     | 15  | 20      | 11   |
| 3.5 – 9.8                    | 14                               | 0.41  | 0.93 | 1.2    | 4.5 | 12      | 2.7  |
| > 9.8                        | 12                               | 0.22  | 0.65 | 3.2    | 9.5 | 35      | 7.1  |
| Fiber filter                 | 21                               | 0.43  | 0.53 | 0.83   | 1.4 | 11      | 1.6  |

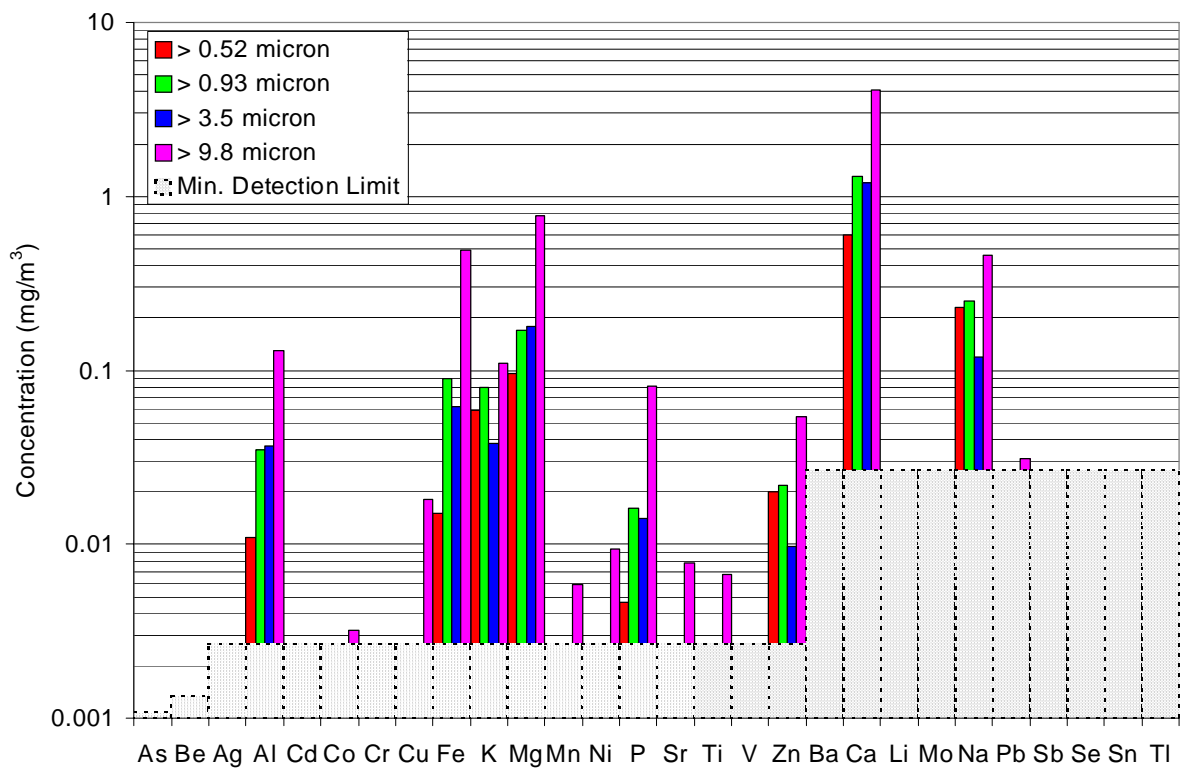
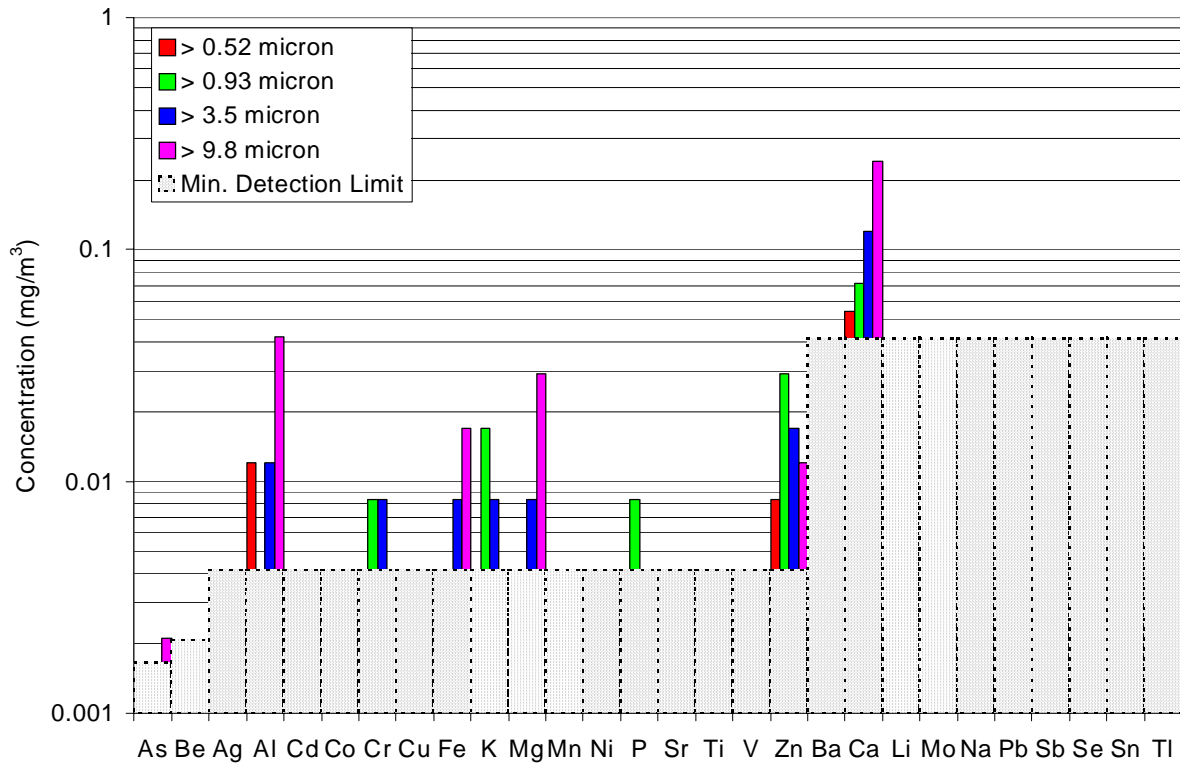
Note: <sup>[1]</sup> Limited to samples with sufficient particle mass collected for analysis (0.020 milligrams).



**Figure 6-4: Distribution of flow corrected accumulated smoke particles in personal cascade impactors.**

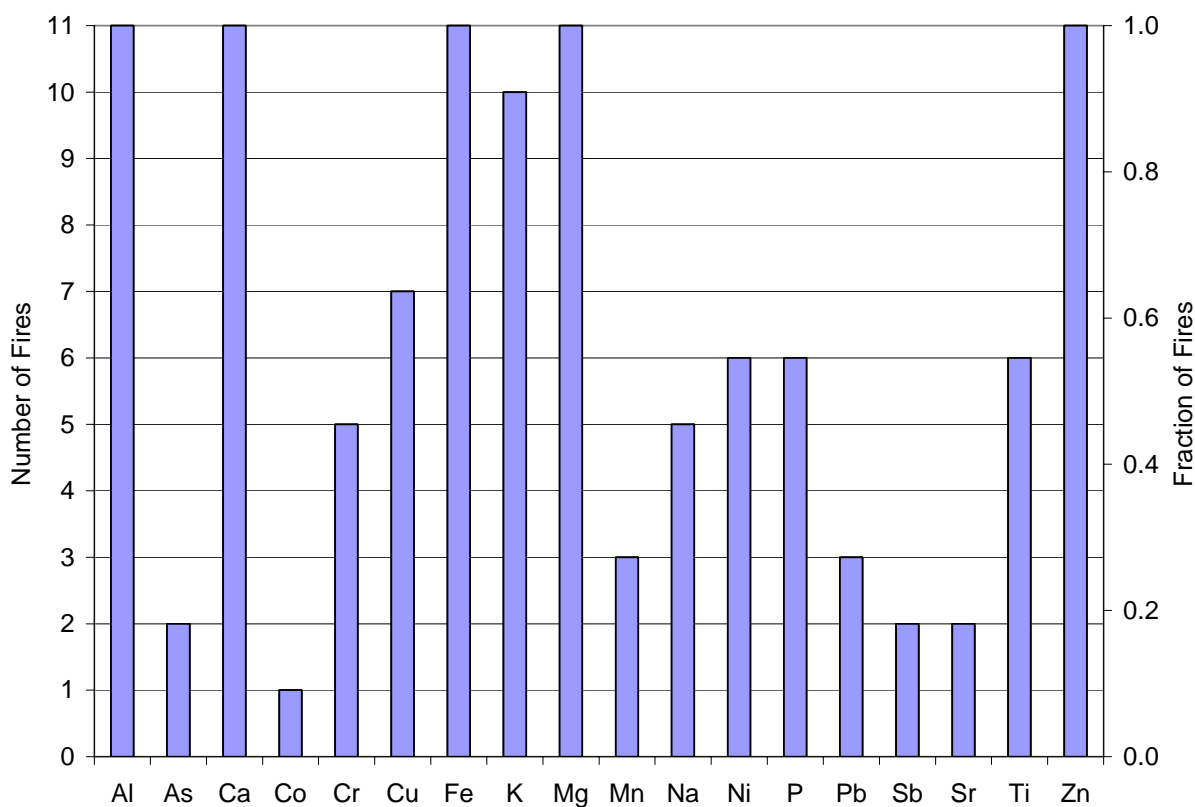
### 6.3.3 Personal Air Sampling – Smoke Particle Inorganic Content

Smoke particles in the firefighters’ personal areas collected on the four personal cascade impactor cut plates were analyzed for inorganic element content. Sampling time (*i.e.* flow volume) corrected concentrations of the inorganic elements were found to vary tremendously from fire to fire. Examples of results from two fires are plotted along with respective minimum quantifiable limits in Figure 6-5.



**Figure 6-5: Examples of inorganic element concentrations measured for two personal cascade impactor smoke particle sets.**

The number of fires in which quantifiable amounts of the various inorganic elements were found in the collected smoke particles is plotted in Figure 6-6. Barium, beryllium, cadmium, lithium, molybdenum, selenium, silver, thallium, tin, and vanadium were not found at quantifiable limits in any of the collected samples. The most frequently found elements (all eleven fires: aluminum, calcium, iron, magnesium, and zinc; ten of eleven fires: potassium) correspond to those most prevalent in the earth's crust<sup>2</sup>. Chromium (used in chrome plating, stainless steel, coloring pigments, leather tanning, and wood preservative along with copper and arsenic prior to 2003) was observed in smoke particles from five fires; lead (used in brass, coloring pigments, and PVC electrical cords) from three fires; antimony (used in conjunction with fire retardants for its synergistic effects), arsenic (used as a wood preservative along with copper and chrome prior to 2003), and strontium (used in television and monitor cathode ray tubes) from two fires each; and cobalt (used in rechargeable batteries and as a coloring pigment) from one fire.

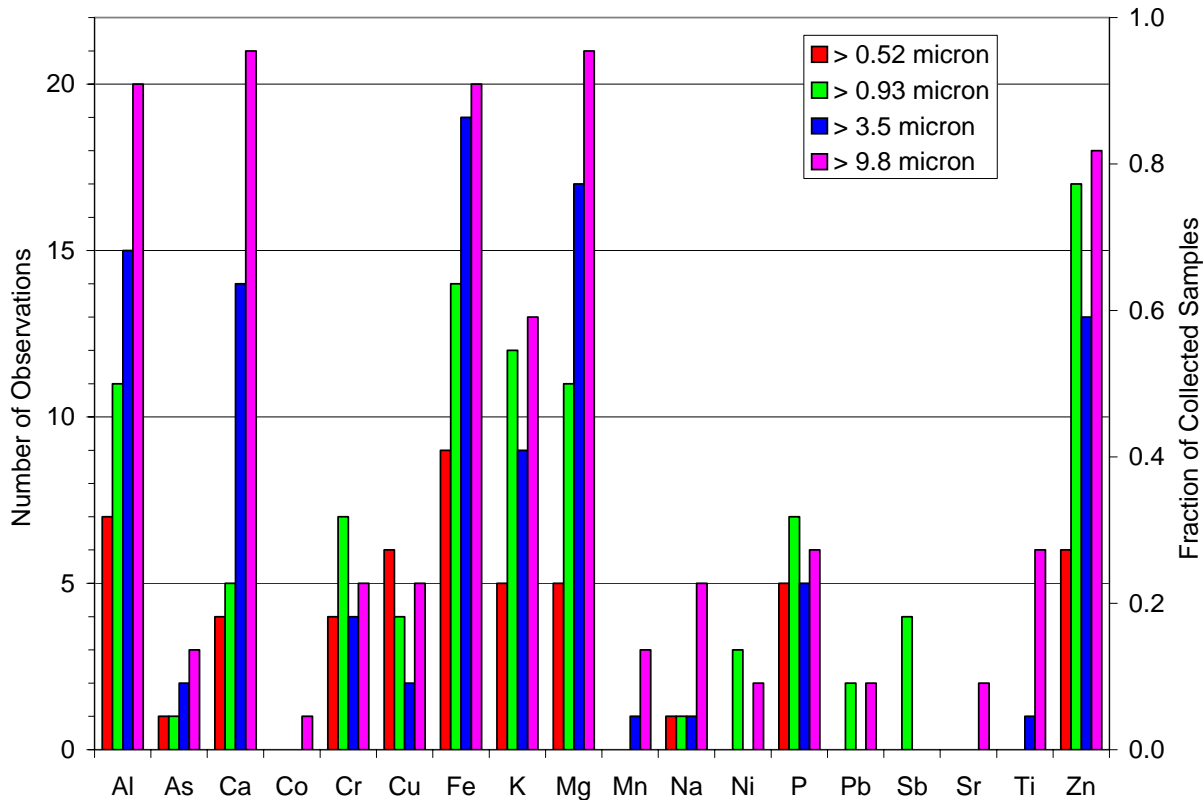


**Figure 6-6: Number of fires in which inorganic elements were found in smoke particles collected with personal cascade impactors.**

Closer examination of the inorganic element content for the smoke particles collected in the four size ranges (0.52 to 0.93, 0.93 to 3.5, 3.5 to 9.8, and greater than 9.8 microns), Figure 6-7, indicates that inorganic elements were generally found more often in larger than smaller smoke particles. For example, aluminum was found in 91% of the collected samples of smoke particles greater than 9.8 microns but in only 68% (15 of 22) of the investigated fires for smoke particles

<sup>2</sup> The most common elements present in the earth's crust are oxygen (46.6%), silicon (27.7%), aluminum (8.1%), iron (5.0%), calcium (3.6%), sodium (2.8%), potassium (2.6%), and magnesium (2.1%). Source: "Windows to the Universe", University Corporation for Atmospheric Research.

between 3.5 and 9.8 microns in size and only 50% of the 0.93 to 3.5 micron particles. Chromium, copper, and phosphorus were found to differ from this trend such that there does not appear to be a clear particle size influence on the number of fires in which these elements were found. Antimony was only found in smoke particles measuring between 0.93 to 3.5 microns in size.



**Figure 6-7: Number of smoke particle samples in which inorganic elements were found as a function of collected particle size.**

Descriptive statistics (minimum, maximum, 1<sup>st</sup> and 3<sup>rd</sup> quartile, median and mean values) of the concentrations for each element-particle size combination are plotted in Figure 6-8 and tabulated in Table 6-9. Measured concentrations for most elements ranged between 0.004 and 1 mg/m<sup>3</sup> with the greatest concentrations seen for calcium and sodium. Although antimony and lead were infrequently found, two and three fires respectively, the measured concentrations were greater than for most of the other elements. The concentrations of aluminum, calcium, copper, iron, and magnesium were found to increase with smoke particle size while concentrations for the other elements did not appear to.

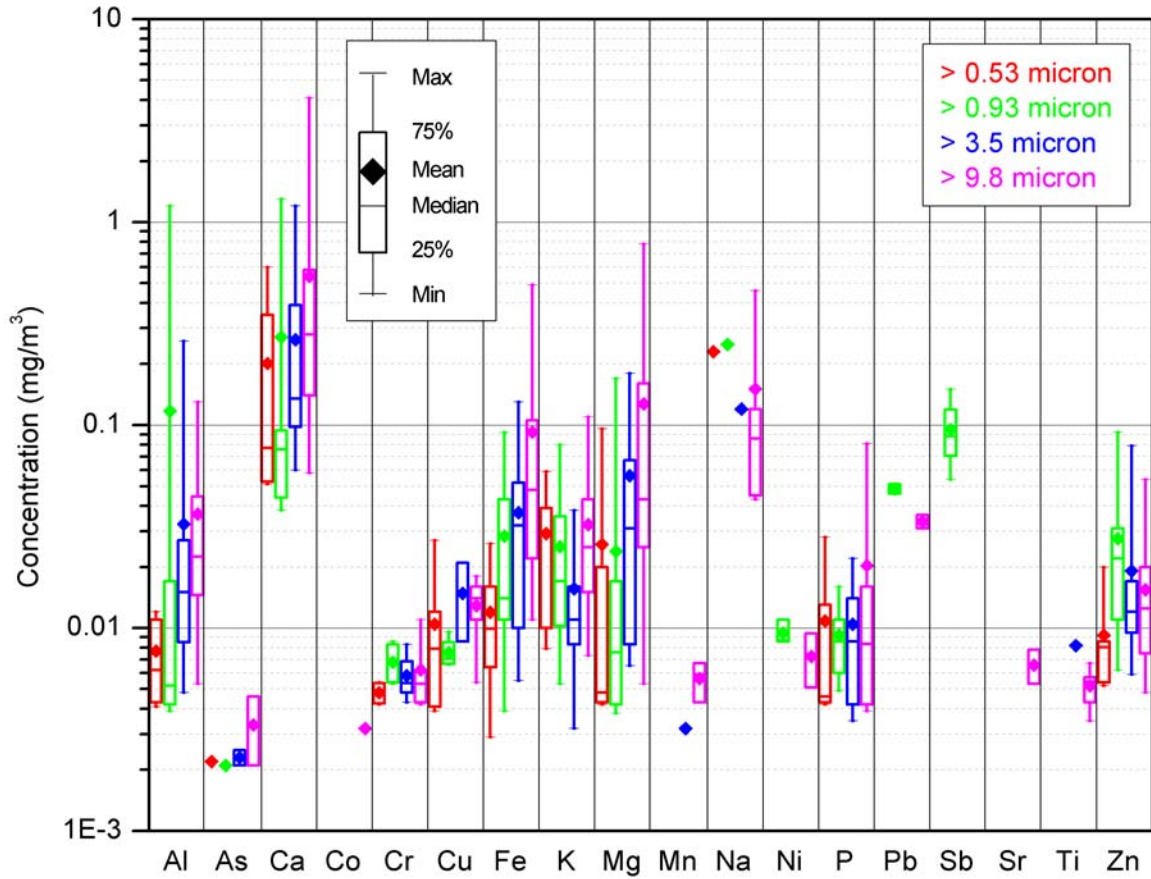


Figure 6-8: Inorganic element concentration distributions measured for different size smoke particles.

**Table 6-9: Descriptive statistics for inorganic element concentrations measured in different sized smoke particles.**

| Cut Plate   | Element | Number of samples <sup>[1]</sup> | Concentration (mg/m <sup>3</sup> ) |        |        |        |         |        |
|-------------|---------|----------------------------------|------------------------------------|--------|--------|--------|---------|--------|
|             |         |                                  | Minimum                            | Q1     | Median | Q3     | Maximum | Mean   |
| 0.52 micron | Al      | 7                                | 0.0041                             | 0.0043 | 0.0062 | 0.0110 | 0.0120  | 0.0077 |
|             | As      | 1                                | 0.0022                             | na     | 0.0022 | na     | 0.0022  | 0.0022 |
|             | Ca      | 4                                | 0.0510                             | 0.0520 | 0.0770 | 0.4750 | 0.6000  | 0.2010 |
|             | Co      | 0                                | na                                 | na     | na     | na     | na      | na     |
|             | Cr      | 4                                | 0.0042                             | 0.0042 | 0.0048 | 0.0054 | 0.0054  | 0.0048 |
|             | Cu      | 6                                | 0.0039                             | 0.0041 | 0.0079 | 0.0158 | 0.0270  | 0.0105 |
|             | Fe      | 9                                | 0.0029                             | 0.0047 | 0.0099 | 0.0185 | 0.0260  | 0.0120 |
|             | K       | 5                                | 0.0079                             | 0.0090 | 0.0300 | 0.0490 | 0.0590  | 0.0292 |
|             | Mg      | 5                                | 0.0042                             | 0.0043 | 0.0048 | 0.0580 | 0.0960  | 0.0259 |
|             | Mn      | 0                                | na                                 | na     | na     | na     | na      | na     |
|             | Na      | 1                                | 0.2300                             | na     | 0.2300 | na     | 0.2300  | 0.2300 |
|             | Ni      | 0                                | na                                 | na     | na     | na     | na      | na     |
|             | P       | 5                                | 0.0042                             | 0.0043 | 0.0046 | 0.0205 | 0.0280  | 0.0108 |
|             | Pb      | 0                                | na                                 | na     | na     | na     | na      | na     |
|             | Sb      | 0                                | na                                 | na     | na     | na     | na      | na     |
|             | Sr      | 0                                | na                                 | na     | na     | na     | na      | na     |
|             | Ti      | 0                                | na                                 | na     | na     | na     | na      | na     |
| Zn          | 6       | 0.0052                           | 0.0054                             | 0.0081 | 0.0115 | 0.0200 | 0.0092  |        |
| 0.93 micron | Al      | 11                               | 0.0040                             | 0.0040 | 0.0050 | 0.0170 | 1.2000  | 0.1170 |
|             | As      | 1                                | 0.0021                             | na     | 0.0021 | na     | 0.0021  | 0.0021 |
|             | Ca      | 6                                | 0.0380                             | 0.0430 | 0.0760 | 0.3960 | 1.3000  | 0.2710 |
|             | Co      | 0                                | na                                 | na     | na     | na     | na      | na     |
|             | Cr      | 7                                | 0.0053                             | 0.0054 | 0.0070 | 0.0083 | 0.0086  | 0.0068 |
|             | Cu      | 4                                | 0.0066                             | 0.0066 | 0.0071 | 0.0091 | 0.0096  | 0.0076 |
|             | Fe      | 14                               | 0.0039                             | 0.0104 | 0.0140 | 0.0443 | 0.0920  | 0.0284 |
|             | K       | 12                               | 0.0053                             | 0.0099 | 0.0170 | 0.0403 | 0.0800  | 0.0252 |
|             | Mg      | 11                               | 0.0038                             | 0.0042 | 0.0076 | 0.0170 | 0.1700  | 0.0239 |
|             | Mn      | 0                                | na                                 | na     | na     | na     | na      | na     |
|             | Na      | 1                                | 0.2500                             | na     | 0.2500 | na     | 0.2500  | 0.2500 |
|             | Ni      | 3                                | 0.0086                             | 0.0086 | 0.0087 | 0.0110 | 0.0110  | 0.0094 |
|             | P       | 7                                | 0.0049                             | 0.0060 | 0.0086 | 0.0110 | 0.0160  | 0.0092 |
|             | Pb      | 2                                | 0.0460                             | na     | 0.0485 | na     | 0.0510  | 0.0485 |
|             | Sb      | 4                                | 0.0540                             | 0.0623 | 0.0880 | 0.1347 | 0.1500  | 0.0950 |
|             | Sr      | 0                                | na                                 | na     | na     | na     | na      | na     |
|             | Ti      | 0                                | na                                 | na     | na     | na     | na      | na     |
| Zn          | 17      | 0.0062                           | 0.011                              | 0.022  | 0.038  | 0.092  | 0.02759 |        |

Table 6-9: CONTINUED

| Cut Plate  | Element | Number of samples <sup>[1]</sup> | Concentration (mg/m <sup>3</sup> ) |         |         |          |         |          |
|------------|---------|----------------------------------|------------------------------------|---------|---------|----------|---------|----------|
|            |         |                                  | Minimum                            | Q1      | Median  | Q3       | Maximum | Mean     |
| 3.5 micron | Al      | 15                               | 0.0048                             | 0.0085  | 0.015   | 0.027    | 0.26    | 0.0325   |
|            | As      | 2                                | 0.0021                             | na      | 0.0023  | na       | 0.0025  | 0.0023   |
|            | Ca      | 14                               | 0.06                               | 0.097   | 0.135   | 0.395    | 1.2     | 0.2634   |
|            | Co      | 0                                | na                                 | na      | na      | na       | na      | na       |
|            | Cr      | 4                                | 0.0043                             | 0.00455 | 0.00535 | 0.007575 | 0.0083  | 0.005825 |
|            | Cu      | 2                                | 0.0086                             | na      | 0.0148  | na       | 0.021   | 0.0148   |
|            | Fe      | 19                               | 0.0055                             | 0.01    | 0.032   | 0.052    | 0.13    | 0.037    |
|            | K       | 9                                | 0.0032                             | 0.0068  | 0.011   | 0.0255   | 0.038   | 0.0156   |
|            | Mg      | 17                               | 0.0065                             | 0.0082  | 0.031   | 0.0935   | 0.18    | 0.0563   |
|            | Mn      | 1                                | 0.0032                             | na      | 0.0032  | na       | 0.0032  | 0.0032   |
|            | Na      | 1                                | 0.12                               | na      | 0.12    | na       | 0.12    | 0.12     |
|            | Ni      | 0                                | na                                 | na      | na      | na       | na      | na       |
|            | P       | 5                                | 0.0035                             | 0.00385 | 0.0086  | 0.018    | 0.022   | 0.01046  |
|            | Pb      | 0                                | na                                 | na      | na      | na       | na      | na       |
|            | Sb      | 0                                | na                                 | na      | na      | na       | na      | na       |
|            | Sr      | 0                                | na                                 | na      | na      | na       | na      | na       |
|            | Ti      | 1                                | 0.0082                             | na      | 0.0082  | na       | 0.0082  | 0.0082   |
| Zn         | 13      | 0.0059                           | 0.00905                            | 0.012   | 0.022   | 0.079    | 0.01909 |          |
| 9.8 micron | Al      | 20                               | 0.0053                             | 0.01375 | 0.0225  | 0.04575  | 0.13    | 0.03642  |
|            | As      | 3                                | 0.0021                             | 0.0021  | 0.0033  | 0.0046   | 0.0046  | 0.003333 |
|            | Ca      | 21                               | 0.058                              | 0.13    | 0.28    | 0.61     | 4.1     | 0.539    |
|            | Co      | 1                                | 0.0032                             | na      | 0.0032  | na       | 0.0032  | 0.0032   |
|            | Cr      | 5                                | 0.0042                             | 0.00425 | 0.0053  | 0.0086   | 0.011   | 0.0062   |
|            | Cu      | 5                                | 0.0054                             | 0.0082  | 0.014   | 0.017    | 0.018   | 0.01288  |
|            | Fe      | 20                               | 0.011                              | 0.0205  | 0.048   | 0.1127   | 0.49    | 0.0923   |
|            | K       | 13                               | 0.0073                             | 0.0145  | 0.025   | 0.0445   | 0.11    | 0.0323   |
|            | Mg      | 21                               | 0.0053                             | 0.025   | 0.043   | 0.18     | 0.78    | 0.127    |
|            | Mn      | 3                                | 0.0043                             | 0.0043  | 0.0059  | 0.0067   | 0.0067  | 0.005633 |
|            | Na      | 5                                | 0.043                              | 0.044   | 0.086   | 0.29     | 0.46    | 0.1508   |
|            | Ni      | 2                                | 0.0051                             | na      | 0.00725 | na       | 0.0094  | 0.00725  |
|            | P       | 6                                | 0.0039                             | 0.0041  | 0.0083  | 0.0323   | 0.081   | 0.0203   |
|            | Pb      | 2                                | 0.031                              | na      | 0.0335  | na       | 0.036   | 0.0335   |
|            | Sb      | 0                                | na                                 | na      | na      | na       | na      | na       |
|            | Sr      | 2                                | 0.0053                             | na      | 0.00655 | na       | 0.0078  | 0.00655  |
|            | Ti      | 6                                | 0.0035                             | 0.0041  | 0.00545 | 0.00595  | 0.0067  | 0.005183 |
| Zn         | 18      | 0.0048                           | 0.00735                            | 0.0125  | 0.02025 | 0.054    | 0.01544 |          |

Note: <sup>[1]</sup> Limited to samples with sufficient particle mass collected for analysis (0.020 milligrams).

Comparison of NIOSH and OSHA exposure limits to the measured inorganic element concentrations, Table 6-10, indicates that eight-hour time weighted average (TWA) exposures were not exceeded at any fire when assuming there was no additional exposure beyond that of the fire scene for the balance of the eight hour period. The STEL for arsenic, however, was exceeded at one fire (#42) and possibly at a second fire (#37). At the fire in which arsenic STEL concentrations were exceeded, the arsenic concentration measured for the largest particles (>9.8 micron) was 0.0046 mg/m<sup>3</sup> and the smaller particles ranged from 0.0021 to 0.0025 mg/m<sup>3</sup> for the



20 minute collection period. Thus the arsenic in just the largest particles was therefore sufficient to exceed STEL concentrations. The second fire in which arsenic was found, a 0.0021 mg/m<sup>3</sup> concentration was calculated for the 25 minute collection period; hence it is theoretically possible that the arsenic STEL was also exceeded at this fire. It should also be noted that none of the monitored gases exceeded exposure limits for fire in which arsenic concentrations did and only carbon monoxide exceeded the STEL for the other fire. NIOSH IDLH concentrations are also presented in Table 6-10 for the reader's reference despite limitations of the utilized collection method that prohibit direct comparison.

**Table 6-10: Number of fires in which inorganic element concentrations exceeded various recommended exposure limits.**

| Element          | NIOSH TWA (mg/m <sup>3</sup> ) <sup>[1]</sup> | No. of Fires Exceeding TWA | NIOSH STEL (mg/m <sup>3</sup> ) | No. of Fires Exceeding STEL | NIOSH IDLH (mg/m <sup>3</sup> ) |
|------------------|---|----------------------------|---------------------------------|-----------------------------|---------------------------------|
| Aluminum (Al)    | 5 <sup>[2]</sup>                              | 0                          |                                 |                             |                                 |
| Antimony (Sb)    | 0.5   | 0                          |                                 |                             | 50                              |
| Arsenic (As)     | 0.01 <sup>[3]</sup>                           | 0                          | 0.002                           | 1 <sup>[4]</sup>            | 5                               |
| Chromium (Cr)    | 0.5   | 0                          |                                 |                             | 250                             |
| Cobalt (Co)      | 0.05  | 0                          |                                 |                             | 20                              |
| Copper (Cu) dust | 1   | 0                          |                                 |                             | 100                             |
| Iron oxide (FeO) | 5   | 0                          |                                 |                             | 2,500                           |
| Lead (Pb)        | 0.05  | 0                          |                                 |                             | 100                             |
| Manganese (Mn)   | 1   | 0                          | 3                               | 0                           | 500                             |
| Nickel (Ni)      | 0.015   | 0                          |                                 |                             | 10                              |
| Phosphorus (P)   | 0.1   | 0                          |                                 |                             | 5                               |

Notes: <sup>[1]</sup> Where possible NIOSH limits are used as they are more conservative than OSHA limits

<sup>[2]</sup> Respirable

<sup>[3]</sup> OSHA limit

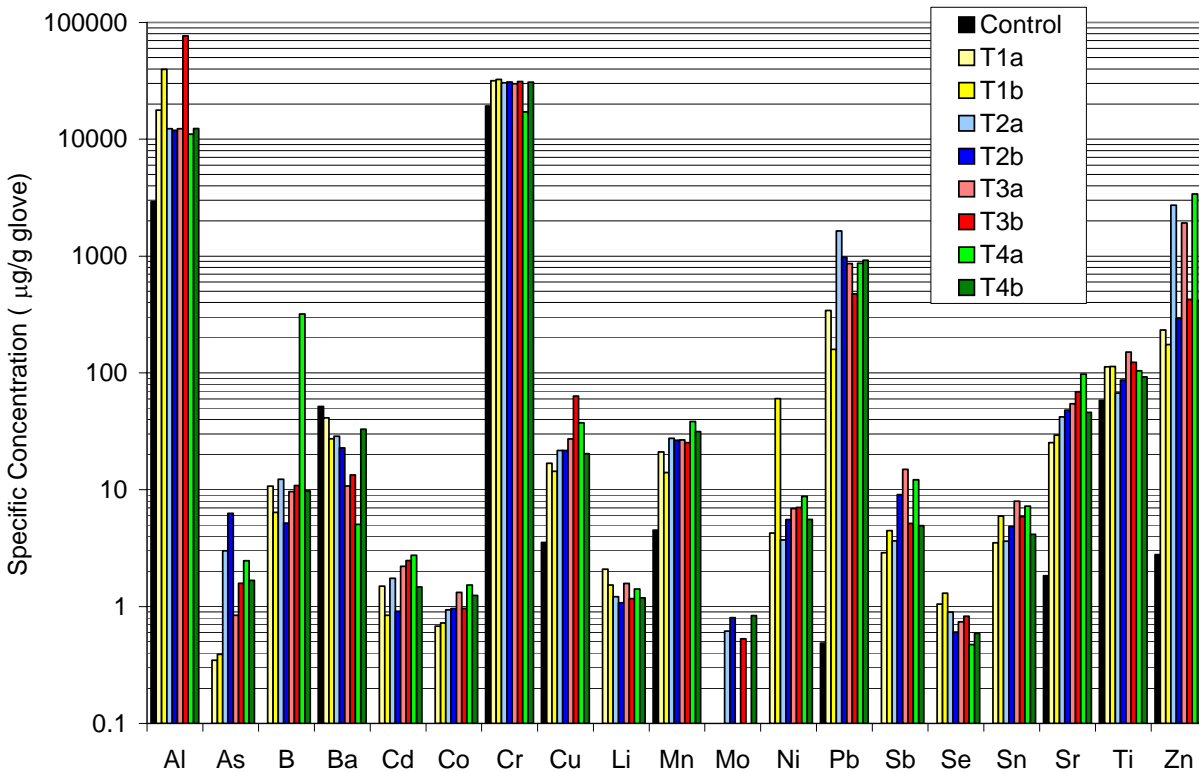
<sup>[4]</sup> It is also theoretically possible that the STEL was exceeded at a second fire.

### 6.3.4 Hood and Glove – Inorganic Content

Gloves and hoods used by the firefighters were analyzed for inorganic element content. Concentrations measured for the used gloves are plotted along with the unused control sample in Figure 6-9. Silver, beryllium, thallium, thorium, uranium, and vanadium were not found in any of the gloves. Generally measured element concentrations increased with usage, except barium and selenium. Barium concentrations decreased from unused control glove sample level with exposure time/usage; selenium concentrations also decreased with usage however no measurable levels of selenium were found in the unused control glove sample.

The most prevalent inorganic element found in the glove samples was chromium at concentration levels of 20,000 to 30,000 micrograms per gram of glove. The concentrations measured for the used glove samples were within a factor of two of the unused control glove sample. These consistent and high concentrations are most likely from chromium compounds used in leather tanning. The next most prevalent elements were aluminum, lead and zinc with concentrations consistently greater than 100 micrograms/g glove. Lead concentrations ranged from 150 to 1,500 micrograms per gram of glove, or nominally 150 to 1,500 ppm. In comparison to these measured lead concentrations, CPSIA Public Law 110-314 limits lead in paint to 90 ppm

and lead in children’s toys to 100 ppm effective (if technologically feasible)<sup>3</sup>. Concentrations of arsenic, which were found to exceed NIOSH STEL concentrations in at least one fire, were found to lie between 0.3 and 6.3 micrograms per gram of glove.



**Figure 6-9: Inorganic element concentration measured in exposed and unexposed firefighter gloves.**

Concentrations measured for the used hoods are plotted along with the unused control sample in Figure 6-10. Silver, beryllium, cadmium, cobalt, molybdenum, selenium, tin, thallium, thorium, uranium, and vanadium were not found in any of the hoods. Not unexpectedly measured concentrations were found to be roughly 10 to 100 times less than those measured for the corresponding gloves. Presumably the greater concentrations found in the gloves is due to transfer from direct handling of charred remains as well as smoke and laden equipment. Antimony and arsenic concentrations were roughly 1/10<sup>th</sup> glove concentrations. Chromium concentrations were approximately 1/1000<sup>th</sup> that of the gloves, which would further support the leather tanning process as the main source of the chromium found in the gloves. Barium concentrations appear to plateau to the same 10 microgram per gram sample concentration as with the gloves. Aluminum, lead and zinc were found at the greatest concentrations, 10 to 150 micrograms per gram of hood, and concentration appears to increase with usage.

<sup>3</sup> Effective August 14, 2011.

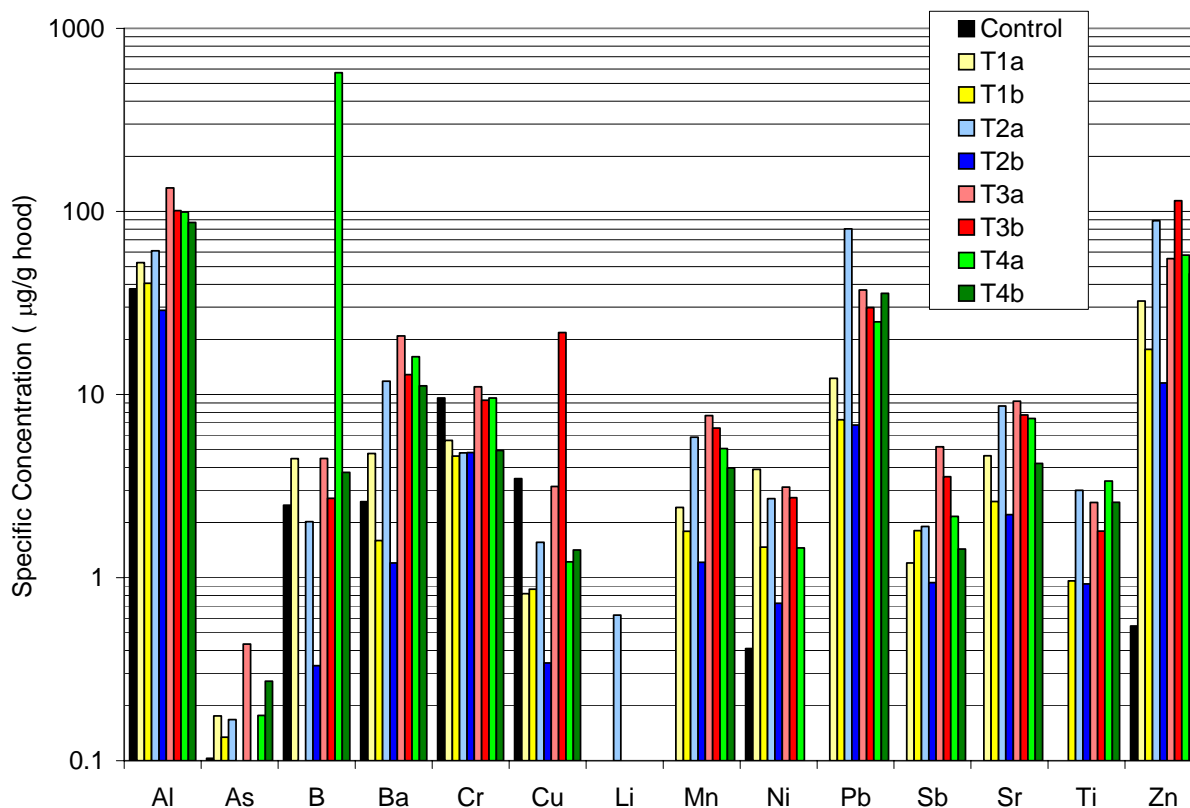
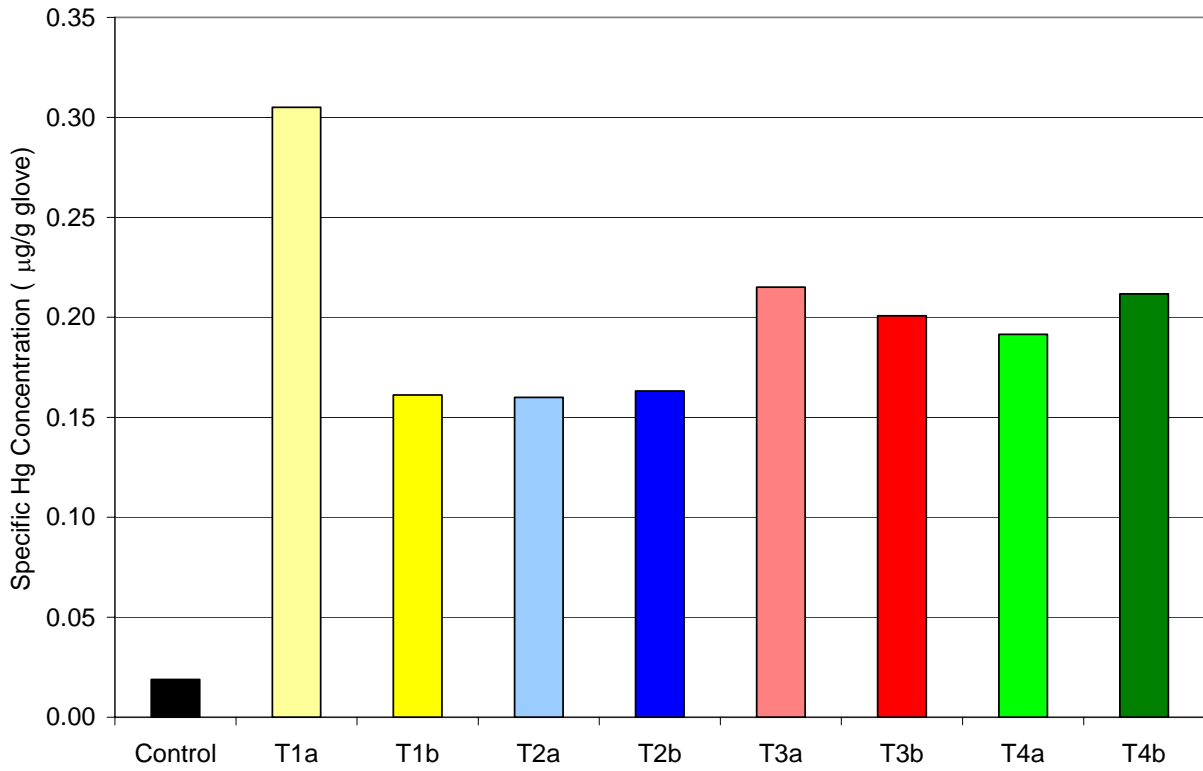


Figure 6-10: Inorganic element concentration measured in exposed and unexposed firefighter hoods.

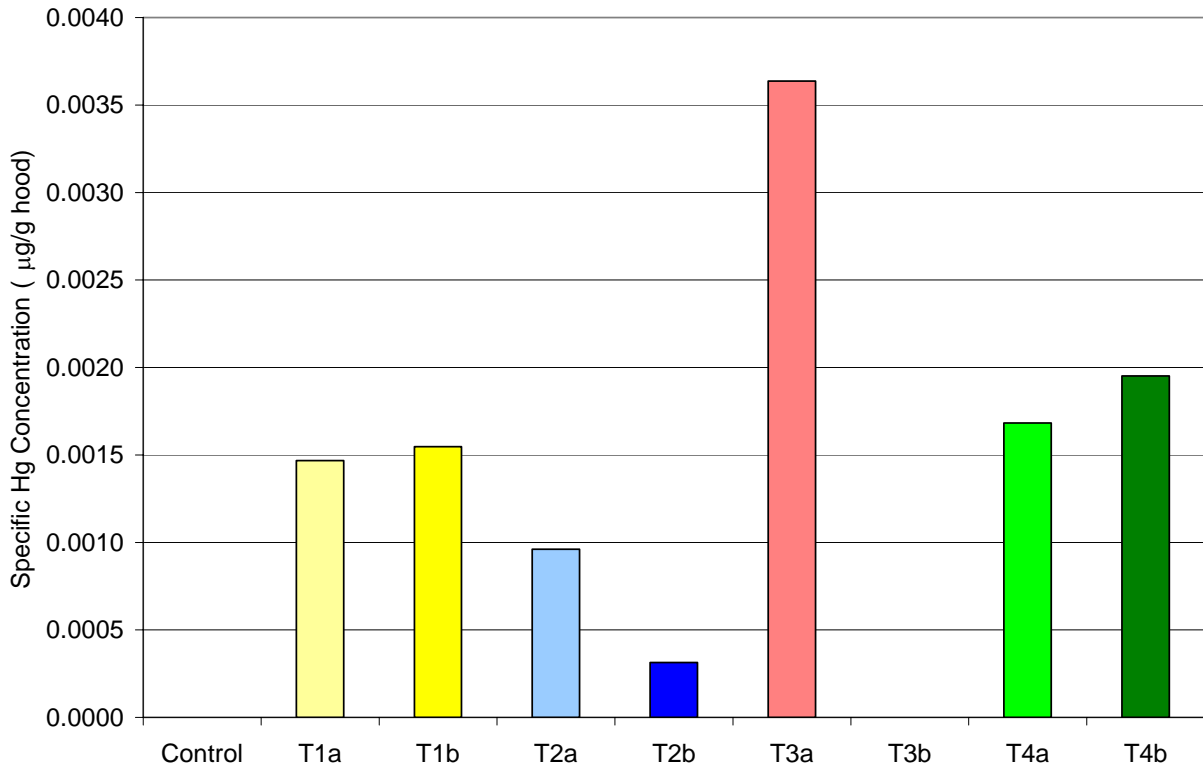
It is also worth noting that firefighter T4a’s hood and glove exhibited unusually high boron contents suggesting the firefighter using that garment set was exposed to high boron levels at one or more fires they responded to that the other participating firefighters did not. Of these seven fires in question (#15, 19, 20, 22, 28, 31, and 34), fire #34 was an attic fire in which firefighter T4a conducted overhaul activities. It is quite possible that borosilicates in the glass fiber insulation used in attic spaces were the source of the boron.

### 6.3.5 Hood and Glove – Mercury Content

Mercury concentrations in unexposed and exposed gloves and hoods are plotted in Figure 6-11 and Figure 6-12 respectively. No mercury was found in the unexposed hood but the unexposed glove had 0.02 micrograms per gram of glove, presumably from the leather tanning process. Mercury concentration in the exposed gloves was roughly 100 times greater than that of the exposed hoods, consistent with findings for the inorganic elements. Mercury levels in the gloves ranged from 0.16 to 0.3 micrograms per gram of glove and in the hoods up to 0.0036 micrograms per gram of hood. While NIOSH TWA levels for airborne mercury, 50 microgram/m<sup>3</sup>, cannot be directly compared to the measured results for the gloves and hoods, it does provide a perspective on the potential significance of the mercury accumulation in firefighter gloves and hoods.



**Figure 6-11: Mercury content in exposed and unexposed firefighter gloves.**



**Figure 6-12: Mercury content in exposed and unexposed firefighter hoods.**

### 6.3.6 Hood and Glove – Organic Content

PAH and other organic compound content were characterized for the gloves and hoods worn by the outfitted firefighters. Measured concentrations are plotted in Figure 6-13 for the gloves and in Figure 6-14 for the hoods. Consistent with trends seen for mercury and the other inorganic elements, concentrations of the organic compounds were approximately 100 times greater for the gloves than the hoods. In both cases however the most commonly found chemicals were phthalate esters, di-2-ethylhexylphthalate in particular. phthalate esters are used as plasticizers to improve plastic mechanical properties such as flexibility and tend to volatilize at elevated temperatures associated with flaming and smoldering combustion. Di-2-ethylhexylphthalate is classified by the EPA as group *B2 – probable human carcinogen* and has a NIOSH STEL of 10 mg/m<sup>3</sup> and a NIOSH TWA of 5 mg/m<sup>3</sup>, Table 6-11. The second most commonly found type of chemicals was phenols. Most phenol derivatives have not been rated for their potential carcinogenicity however phenol has and is classified by the EPA as group *D – not classifiable as to human carcinogenicity*. NIOSH has developed skin exposure STEL and TWA of 15.6 and 5 ppm respectively to which the 0.01 ppm phenol concentration for hoods can be compared. Of potentially greater concern are the materials classified as EPA group *A2 – suspected human carcinogens* (benzo[a]anthracene, benzo[a]pyrene), EPA group *A3 – confirmed animal carcinogen with unknown relevance to humans* (chrysene), and IARC group *2A – probably carcinogenic to humans* (dibenzo[a,h]anthracene). While each of these four chemicals was found in at least three of eight used gloves, none of the concentrations exceeded 0.02 micrograms per gram glove. For reference purposes the NIOSH TWA limits for these chemistries in airborne form are 200 µg/m<sup>3</sup>.

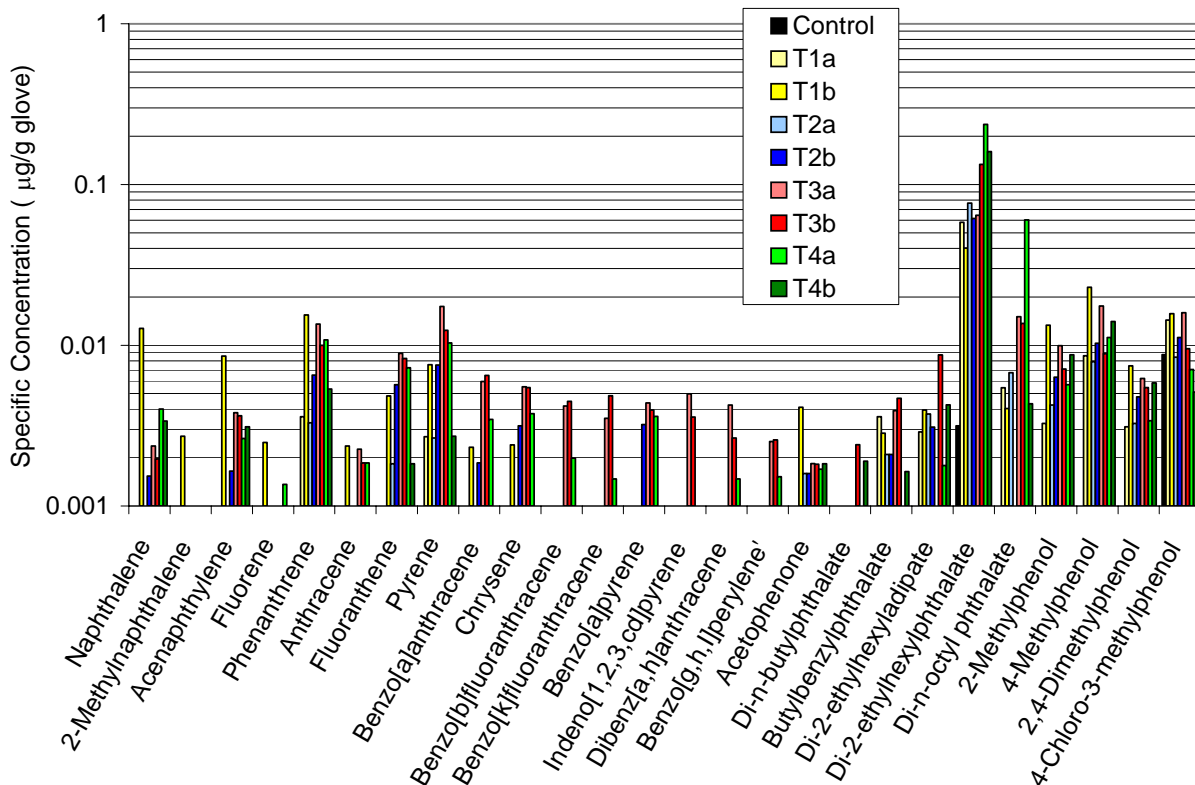


Figure 6-13: PAH and other organic compound content of unexposed and exposed firefighter gloves.

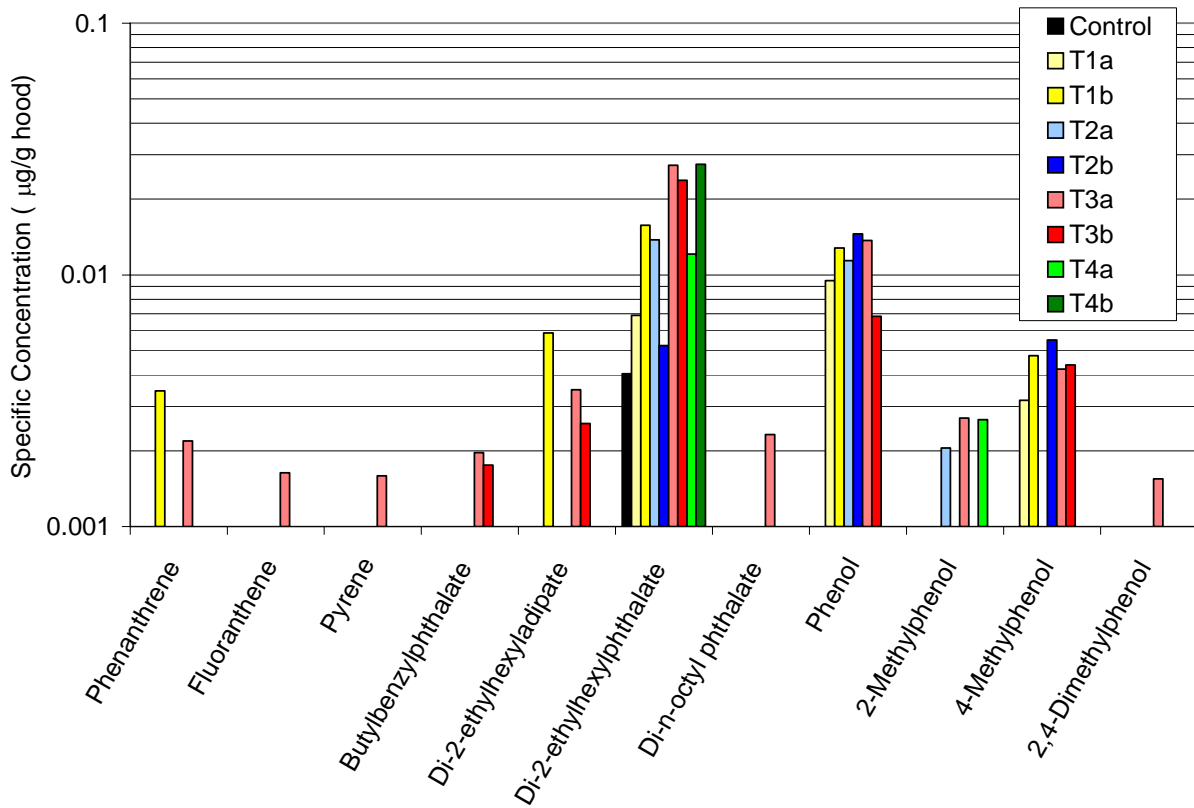


Figure 6-14: PAH and other organic compound content of unexposed and exposed firefighter hoods.

**Table 6-11: Exposure limits and environmental classifications for PAH and other organic compounds.**

| Species                  | NIOSH IDLH                                  | NIOSH STEL                              | NIOSH TWA                            | Carcinogenic Classification <sup>[1]</sup> |
|--------------------------|---|---|--------------------------------------|--|
| Naphthalene              | 250 ppm                                     | 75 mg/m <sup>3</sup><br>(15 ppm)        | 50 mg/m <sup>3</sup><br>(10 ppm)     | ACGIH A4                                   |
| 2-methylnaphthalene      |   |   |                                      | Not rated                                  |
| Acenaphthylene           |   |   |                                      | Not rated                                  |
| Fluorene                 |   |   |                                      | IARC 3                                     |
| Phenanthrene             |   |   | 0.2 mg/m <sup>3</sup>                | IARC 3                                     |
| Fluoranthene             |   |   |                                      | IARC 3                                     |
| Anthracene               |   |   | 0.2 mg/m <sup>3</sup>                | IARC 3                                     |
| Pyrene                   |   |   | 0.2 mg/m <sup>3</sup>                | IARC 3                                     |
| Benzo[a]anthracene       |   |   | 0.2 mg/m <sup>3</sup>                | EPA A2                                     |
| Chrysene                 |   |   | 0.2 mg/m <sup>3</sup>                | EPA A3                                     |
| Benzo[b]fluoranthracene  |   |   |                                      | Not rated                                  |
| Benzo[k]fluoranthracene  |   |   |                                      | Not rated                                  |
| Benzo[a]pyrene           |   |   | 0.2 mg/m <sup>3</sup>                | EPA A2                                     |
| Indeno[1,2,3,cd]pyrene   |   |   |                                      | Not rated                                  |
| Dibenzo[a,h]anthracene   |   |   |                                      | IARC 2A                                    |
| Benzo[g,h,i]perylene     |   |   |                                      | Not rated                                  |
| Acetophenone             | ACGIH TLV 10<br>ppm (49 mg/m <sup>3</sup> ) |   |                                      | Not rated                                  |
| Di-n-butylphthalate      | 5,000 mg/m <sup>3</sup>                     |   | 5 mg/m <sup>3</sup>                  | Not rated                                  |
| Butylbenzylphthalate     |   |   |                                      | IARC 3                                     |
| Di-2-ethylhexyladipate   |   |   |                                      | IARC 3                                     |
| Di-2-ethylhexylphthalate |   | 10 mg/m <sup>3</sup>                    | 5 mg/m <sup>3</sup>                  | EPA B2                                     |
| Di-n-octyl phthalate     |   |   |                                      | Not rated                                  |
| Phenol                   | 250 ppm                                     | 60 mg/m <sup>3</sup><br>(15.6 ppm) skin | 19 mg/m <sup>3</sup><br>(5 ppm) skin | EPA D                                      |
| 2-Methylphenol           |   |   |                                      | Not rated                                  |
| 4-Methylphenol           |   |   |                                      | Not rated                                  |
| 2,4-Dimethylphenol       |   |   |                                      | Not rated                                  |
| 4-Chloro-3-methylphenol  |   |   |                                      | Not rated                                  |

Note: <sup>[1]</sup> Definition of carcinogenic classifications –  
 EPA A2: suspected human carcinogen  
 EPA A3: confirmed animal carcinogen with unknown relevance to humans  
 EPA B2: probable human carcinogen  
 EPA D: not classifiable as to human carcinogenicity  
 IARC 2A: probably carcinogenic to humans  
 IARC 3: not classifiable as to its carcinogenicity to humans  
 ACGIH A4: not classifiable as a human carcinogen

## CHAPTER 7: HEALTH IMPLICATIONS

### 7.0 CHEMICAL SPECIFIC HEALTH IMPACTS

Potential health impacts resulting from exposure to the measured chemicals are listed below.

*Ammonia*: Irritant to eyes, skin and airways. Symptoms of mild to moderate exposure: headache, salivation, burning of throat, perspiration, nausea and vomiting. Prolonged exposure causes cough or respiratory arrest or bronchitis following exposure.

*Carbon monoxide*: asphyxiant interfering with oxygen-carrying capacity of blood. Symptoms of acute poisoning: headache, dizziness, drowsiness, nausea, fainting, coma and death. Cardiac effects: Enhancement of exercise-induced angina.

*Hydrogen cyanide*: asphyxiant affecting fundamental aspects of the respiratory process. Lower exposures cause weakness, headache, confusion, nausea and vomiting. Higher exposures may cause loss of consciousness and death.

*Hydrogen sulfide*: irritant and neurologic toxicant. Lower exposures may cause headache, dizziness, nausea and diarrhea. Higher exposures may cause respiratory failure, coma and death.

*Nitrogen dioxide*: irritant to the eyes and airways. Lower exposures may cause temporary bronchitis, which can disappear but later develop later into pulmonary edema. Higher exposures may cause chills, fever, malaise, nausea and vomiting and death if sufficiently high.

*Sulfur dioxide*: Strong irritant to eyes and upper airways. Asphyxiant at high exposures resulting in death. Lower chronic exposures cause fatigue, throat dryness, cough and nasal irritation. Long term effects may include bronchopneumonia and bronchitis. Pulmonary effects may be increased by respirable particle inhalation.

*Polycyclic aromatic hydrocarbons*: Chemical class of which benzo(a)pyrene is a common constituent and the most studied. Carcinogenic toward several tissues, including skin, mammary glands and respiratory system in experimental animals.

*Phthalate esters*: Class of chemicals used principally as plasticizers. A typical member of this class, di-(2-ethylhexyl)phthalate (DEHP) is an irritant for the eyes and mucous membranes and may cause nausea and diarrhea. It is also according to EPA classification of B2 an animal, and a probable human, carcinogen.

### 7.1 RESPIRATORY

The potential for municipal firefighters to experience acute and/or chronic respiratory health effects related to their workplace exposures has long been recognized. Specific potential exposures of concern for firefighters because of their potential respiratory toxicity include: (1) asphyxiants such as carbon monoxide, carbon dioxide and hydrogen sulfide; (2) irritants such as ammonia, hydrogen chloride, particulates, nitrogen oxides, phenol and sulfur dioxide; (3) allergens such as isocyanates, (4) respiratory carcinogens such as chromium and polycyclic aromatic hydrocarbons and (5) respirable particles ([www.toxnet.nlm.nih.gov](http://www.toxnet.nlm.nih.gov)).



Concentrations of several of these respiratory toxicants exceeded OSHA regulatory exposure limits and/or recommended exposure limits from NIOSH or ACGIH. (See Tables) These findings are consistent with previous studies evaluating firefighter workplace exposures, as well as with other studies evaluating workplace ultrafine particle exposure levels in a broader occupational health context<sup>1-4</sup>. A correlation between exposure to respirable particles and a biomarker of increased lung permeability has also been found in one group of firefighters.

Exposures to specific respiratory toxicants can produce acute respiratory effects that may result in chronic respiratory disease. The acute effects vary depending upon the toxicant, the nature/severity of the exposure(s) and other factors such as the medical history of the person exposed.<sup>5</sup>

Previous studies have not resulted in definitive conclusions as to the chronic respiratory health effects of exposures related to varied exposures in firefighting activities. Consequently, further research is needed to define the potential long-term respiratory health impact of the varied and complex mix of exposures such as those identified in this report and to inform decisions as to the selection and utilization of respiratory protection, especially during overhaul activities.

## 7.2 CARDIOVASCULAR

Several factors have been implicated in the induction of cardiovascular events in firefighters, including, excess weight/obesity, reduced physical fitness, heat and emotional stresses, and chemical and particulate exposures<sup>6-11</sup>. A highly significant finding in our studies was the generation of ultrafine particles at high levels relative to background and as the most prevalent, type of particulate matter during combustion of a range of common residential materials and products. This was true for all stages of fire suppression during which firefighter deaths from coronary heart disease and early retirement-related nonfatal coronary heart disease events have been found to principally occur relative to non-emergency duties<sup>12</sup>, including knockdown and overhaul. Firefighters are exposed to high levels of ultrafine particles throughout fire suppression, but during overhaul usually remove Self-Contained Breathing Apparatus (SCBA) which is frequently worn during other activities.

A positive correlation has been established between increased exposure to urban air pollution related particulate matter (PM10 and PM2.5) and increased cardiovascular morbidity and mortality in general population studies.<sup>13-17</sup> The corresponding relationship for ultrafine particles is currently unclear<sup>13-17</sup>. The density of ultrafine particles in urban air ranges from  $5 \times 10^3$  to greater than  $3 \times 10^5$  particles per cubic centimeter<sup>18</sup>; the values in the upper part of this range are therefore comparable to those found during fire suppression in this study. Ultrafine particles are generated primarily from fossil fuel combustion sources such as coal powered utilities and diesel engines in urban situations, however their number densities vary with time of day and decrease rapidly with distance from the source of generation as agglomeration increases particle diameters<sup>19</sup>. In recent clinical studies short-term exposures in healthy volunteers at average levels as low as  $1.2$  to  $1.45 \times 10^5$  ultrafine particles/cubic centimeter induced a variety of changes in cardiovascular parameters<sup>20, 21</sup>. A recent study examining the impact of ultrafine diesel exhaust particle exposure in construction workers showed analogous adverse effects on coronary heart disease<sup>22</sup>.

The invisibility of ultrafine particles to the human eye may create a false sense of safety that leads firefighters to remove their protective equipment in order to ameliorate the physical burden and potential heat stress associated with continued utilization of SCBA during overhaul. Recommendations for more consistent utilization of respiratory protective equipment during overhaul stemmed from previous firefighter studies showing that levels of exposure to several volatile chemicals, but not respirable or total particles, exceeded published ceiling exposure guidelines during this activity<sup>23</sup>. Changes in spirometric measurements and lung permeability parameters were also reported in firefighters not wearing respiratory protection<sup>24</sup>. The most appropriate method of utilization and type of respiratory protective equipment required to limit firefighters' workplace exposures to ultrafine particles requires further research<sup>25,26</sup>. These findings are consistent with other studies in terms of the relationship between background and workplace ultrafine particle exposure levels<sup>27-30</sup> in a broader occupational health context. Ultrafine particle concentrations ranged from  $1.2 \times 10^4$  to  $1.3 \times 10^5$  particles/cubic centimeter in an industrial setting involving welding, smelting, molding, laser cutting and fettling (removing excess materials from aluminum molds)<sup>29</sup>.

Healthcare workers experienced brief exposure to ultrafine particles in excess of  $1.0 \times 10^5$  particles per cubic centimeter during the use of electrocautery, lasers and ultrasonic scalpels in healthcare surgical settings<sup>30</sup>. In this study number densities in excess of these values were generally observed ( $4.6 \times 10^4$  to  $2.1 \times 10^6$  per cubic centimeter for scenarios involving structural materials and  $2.0 \times 10^4$  per cubic centimeter for the automobile passenger compartment). Instrument probe position during particle collection was not optimized, however, which could have led to underestimation of particle number densities in our studies.

These study results identify elevated ultrafine particle exposure as an additional risk factor that may account in part for the elevated cardiovascular morbidity and mortality associated with fire suppression activities. There is also an intense effort at the present time to characterize exposures and identify potential health effects from occupational and environmental exposures to engineered nanomaterials, which have the same physical dimensions as ultrafine particles.

In addition to ultrafines, other types of particulate matter and a variety of chemical exposures, such as toxic gases, including carbon monoxide and hydrogen sulfide, are suspected to be involved in occupationally-related cardiovascular disease, and have been detected in fire suppression situations on multiple occasions<sup>31</sup>. Possible interactions between the many agents and physiologic factors implicated and their relative contributions to cardiovascular disease in firefighters remain to be determined.

### 7.3 CANCER

Analysis of particulates and airborne agents in several model fire scenarios and firefighters' personal areas revealed measurable concentrations of metals and volatile organic compounds classified as possible or probable human carcinogens, including arsenic, cadmium<sup>32</sup>, chromium<sup>33</sup>, nickel<sup>34</sup>, benzene<sup>35</sup>, formaldehyde<sup>36</sup>, styrene<sup>37</sup>, phthalate esters and certain polycyclic aromatic hydrocarbons (PAH)<sup>38</sup>.

Formaldehyde was measured at levels above detection limits for all large-scale fire scenarios, whereas this was found for benzene and styrene in only half or less. Formaldehyde concentrations exceeded NIOSH ceiling limits for attic, kitchen, bedroom, living room and composite deck when area stands were used, although not consistently between the two instruments used. Concentrations of the other agents did not exceed OSHA PEL, NIOSH REL, ACGIH TLV or IDLH limits in any scenarios, and were not consistently detected above detection limits. Only chromium was detectable above detection limits in the majority of scenarios.

Concentrations of the metals did not, however, exceed OSHA PEL or NIOSH REL limits in any of the investigated Chicago metropolitan area fires, and were not consistently detected above detection limits fires for the balance of the eight hour exposure limit. The STEL for arsenic was exceeded at least one fire and possibly in a second fire. Measurable concentrations of arsenic, chromium and nickel were also found in hoods and gloves, as well as several PAHs and phthalate ester plasticizers. Several agents in these categories are listed as probable human carcinogens.

These studies therefore verify previous findings that firefighters are exposed to a wide range of inorganic (metal-containing) and organic carcinogens. When considered on an individual basis, the majority of these agents are not consistently found at levels that exceed federal regulatory limits, though the possibility exists that interaction between individual agents could lead to additive or synergistic effects.

#### **7.4 OTHER**

This initial characterization of contaminant deposition on firefighter protective equipment (gloves and hoods) provides preliminary data regarding the types of contaminants and levels of deposition during short-term equipment use in the field during firefighting activities. Findings of note include deposition of lead, mercury, phthalate esters and PAHs on firefighter protective equipment. Future research is needed to further characterize the deposition of contaminants on firefighter protective equipment and the subsequent potential for firefighter exposures health effects related to the contaminants, especially where exposure is protracted from seldom-cleaned equipment. Future research also should include studies of the usage and industrial hygiene practices related to the equipment, including cleaning patterns, length of use and storage practices.

#### **7.5 REFERENCES**

1. Dockery DW, Luttmann-Gibson H, Rich DQ. Association of air pollution with increased incidence of ventricular tachyarrhythmias recorded by implanted cardioverter defibrillators. *Environ Health Perspect* 2005;113:670-674.
2. Nemmar A., Hoet PHM, Dinsdale D, Vermeylen J, Hoylaerts MF, Nemery B. Diesel exhaust particles in lung acutely enhance experimental peripheral thrombosis. *Circulation* 2003;107:1202-1208.
3. Mutlu GM, Green D, Bellmeyer A, Baker CM, Burgess Z, Rajamannan N, Christman JW, Foiles N, Kamp DW, Ghio AJ, Chandel NS, Dean DA, Sznajder JI, Budinger GR. Ambient particulate matter accelerates coagulation via an IL-6-dependent pathway. *J Clin Invest* 2007;117: 2952-2961.

4. Baccarelli A, Zanobetti A, Martinelli I, Grillo P, Hou L, Giacomini S, Bonzini M, Lanzani G, Mannucci PM, Bertazzi PA, Schwartz J. Effects of exposure to air pollution on blood coagulation. *J Thromb Haemostasis* 2007; 5:252-260.
5. Elihn K, Berg P. Ultrafine particle characteristics in seven industrial plants. *Ann Occup Hyg* 2009 Jul;53(5):475-484.
6. Geibe JR, Holder J, Peeples, L, Kinney AM, Burress JW, Kales SN. Predictors of on-duty coronary events in male firefighters in the United States. *Am J Cardiol* 2008;101:585-589
7. Yoo HL, Franke WD. Prevalence of cardiovascular disease risk factors in volunteer firefighters. *J Occup Environ Med* 2009;51(8):958-962.
8. Glueck CJ, Kelley W, Wang P, Gartside PS, Black D, Tracy T. Risk factors for coronary heart disease among firefighters in Cincinnati. *Am J Ind Med* 1996;30:331-340.
9. Clark S, Rene A, Theurer WM, Marshall M. Association of body mass index and health status in firefighters. *J Occup Environ Med* 2002;44:940-946.
10. Soteriades ES, Hauser R, Kawachi I, Liarokapis D, Christiani DC, Kales SN. Obesity and cardiovascular disease risk factors in firefighters: a prospective cohort study. *Obes Res* 2005;13:1756-1763.
11. Ide CW. A longitudinal survey of the evolution of some cardiovascular risk factors during the careers of male firefighters retiring from Strathclyde Fire Brigade from 1985–1994. *Scott Med J* 2000;45:79-83.
12. Kales SN, Soteriades ES, Christophi CA and Christiani DC. Emergency Duties and Deaths from Heart Disease among Firefighters in the United States. *New Engl J Med* 2005;356:1207-1215.
13. Laden F, Schwartz J, Speizer FE, Dockery DW. Reduction in Fine Particulate Air Pollution and Mortality. Extended Follow-up of the Harvard Six Cities Study. *Am J Respir Crit Care Med* 2006;173:667–672.
14. Pope CA, Dockery DW. Health effects of fine particulate air pollution: lines that connect. *J Air Waste Manage Assoc* 2006;56:709–742.
15. Peters A., Dockery DW, Muller JE, Mittelman MA. Increased particulate air pollution and the triggering of myocardial infarction. *Circulation* 2001;103: 2810–2815.
16. Gold DR, Litonjua AA, Zanobetti A, Coull BA, Schwartz J, MacCallum G, Verrier RL, Nearing BD, Canner MJ, Suh H, Stone PH. Air pollution and ST-segment depression in elderly subjects. *Environ Health Perspect* 2005;113:883–887.
17. Ibald-Mulli A, Timonen KL, Peters A, Heinrich J, Wölke G, Lanki T, Buzorius G, Kreyling WG, de Hartog J, Hoek G, ten Brink HM, Pekkanen J. Effects of particulate air pollution on blood pressure and heart rate in subjects with cardiovascular disease: a multicenter approach. *Environ Health Perspect* 2004;112:369-377.
18. McMurry, PH; Woo, KS. Size Distributions of 3-100-nm Urban Atlanta aerosols: measurements and observations. *J Aerosol Med* 2002; 15; 169-178.

19. Zhu Y, William C. Hinds WC, Shen S, Sioutas C. Seasonal and Spatial Trends in Fine Particulate Matter. Seasonal Trends of Concentration and Size Distribution of Ultrafine Particles Near Major Highways in Los Angeles. *Aerosol Sci Technol* 2004; 38:5–13.
20. Gong H Jr, Linn WS, Clark KW, Anderson KR, Sioutas C, Alexis NE, Cascio WE, Devlin RB. Exposures of healthy and asthmatic volunteers to concentrated ambient ultrafine particles in Los Angeles. *Inhal Toxicol* 2008;20:533-545.
21. Samet JM, Rappold A, Graff D, Cascio WE, Berntsen JH, Huang YC, Herbst M, Bassett M, Montilla T, Hazucha MJ, Bromberg PA, Devlin RB. Concentrated ambient ultrafine particle exposure induces cardiac changes in young healthy volunteers. *Am J Respir Crit Care Med* 2009;79:1034-1042.
22. Torén K, Bergdahl IA, Nilsson T, Järholm B. Occupational exposure to particulate air pollution and mortality due to ischaemic heart disease and cerebrovascular disease. *Occup Environ Med* 2007;64:515-519.
23. Wittmaack K. In search of the most relevant parameter for quantifying lung inflammatory response to nanoparticle exposure: particle number, surface area, or what? *Environ Health Perspect* 2007;115:187-194.
24. Wiebert P, Sanchez-Crespo A, Seitz J, Falk R, Philipson K, Kreyling WG, Möller W, Sommerer K, Larsson S, Svartengren M. Negligible clearance of ultrafine particles retained in healthy and affected human lungs. *Eur Respir J* 2006 Aug;28(2):286-290.
25. Furuyama A, Kanno S, Kobayashi T, Hirano S. Extrapulmonary translocation of intratracheally instilled fine and ultrafine particles via direct and alveolar macrophage-associated routes. *Arch Toxicol* 2009;83:429-437.
26. Brook RD. Cardiovascular effects of air pollution. *Clin Sci* 2008;115:175-187.
27. Elihn K, Berg P. Ultrafine particle characteristics in seven industrial plants. *Ann Occup Hyg* 2009 Jul;53(5):475-484.
28. Evans DE, Heitbrink WA, Slavin TJ, Peters TM. Ultrafine and respirable particles in an automotive grey iron foundry. *Ann Occup Hyg* 2008;52:9-21.
29. Peters TM, Heitbrink WA, Evans DE, Slavin TJ, Maynard AD. The mapping of fine and ultrafine particle concentrations in an engine machining and assembly facility. *Ann Occup Hyg* 2006;50:249-257.
30. Brüske-Hohlfeld I, Preissler G, Jauch KW, Pitz M, Nowak D, Peters A, Wichmann HE. Surgical smoke and ultrafine particles. *J Occup Med Toxicol* 2008;3:31-45.
31. 2009 at <http://www.iaff.org/HS/phi/phiStates.asp>
32. Huff J, Lunn RM, Waalkes MP, Tomatis L, Infante PF. Cadmium-induced cancers in animals and in humans. *Int J Occup Environ Health*. 2007 Apr-Jun;13(2):202-212.
33. Holmes AL, Wise SS, Wise JP Sr. Carcinogenicity of hexavalent chromium. *Indian J Med Res*. 2008 Oct;128(4):353-372.
34. Zhao J, Shi X, Castranova V, Ding M. Occupational toxicology of nickel and nickel compounds. *J Environ Pathol Toxicol Oncol*. 2009;28(3):177-208.

35. Huff J. Benzene-induced cancers: abridged history and occupational health impact. *Int J Occup Environ Health*. 2007 Apr-Jun;13(2):213-221.
36. Duhayon S, Hoet P, Van Maele-Fabry G, Lison D. Carcinogenic potential of formaldehyde in occupational settings: a critical assessment and possible impact on occupational exposure levels. *Int Arch Occup Environ Health*. 2008 May;81(6):695-710.
37. Rueff J, Teixeira JP, Santos LS, Gaspar JF. Genetic effects and biotoxicity monitoring of occupational styrene exposure. *Clin Chim Acta*. 2009 Jan;399(1-2):8-23.
38. Internal Agency for Research on Cancer. *IARC monographs on the Carcinogenic Risk of chemicals to Humans: Polynuclear Aromatic Hydrocarbons*, vols 32 and 33 Lyon, France (1983).

## CHAPTER 8: SUMMARY OF FINDINGS

A summary of findings from the conducted research investigation is presented herein.

### 8.1 OVERALL

- Concentrations of combustion products were found to vary tremendously from fire to fire depending upon the size of the fires, the chemistry of materials involved in the fires, and the ventilation conditions of the fire.

### 8.2 MATERIAL-SCALE TESTS

- Type and quantity of combustion products (smoke particles and gases) generated depended on the chemistry and physical form of the materials being burned.
- Synthetic materials produced more smoke than natural materials.<sup>1</sup>
  - The most prolific smoke production was observed for styrene based materials commonly found in residential households and automobiles. These materials may be used in commodity form (e.g. disposable plastic glasses and dishes), expanded form for insulation, impact modified form such as HIPS (e.g. appliances and electronics housing), copolymerized with other plastics such as ABS (e.g. toys), or copolymerized with elastomers such as styrene-butadiene rubber (e.g. tires).
  - Vinyl polymers also produced considerable amounts of smoke. Again these materials are used in commodity form (e.g. PVC pipe) or plasticized form (e.g. wiring, siding, resin chairs and tables).
  - As the fraction of synthetic compound was increased in a wood product (either in the form of adhesive or mixture such as for wood-plastic composites), smoke production increased.
  - Average particle sizes ranged from 0.04 to 0.15 microns with wood and insulation creating the smallest particles.
  - For a given particle size, synthetic materials will generate approximately 12.5X more particles per mass of consumed material than wood based materials.
- Combustion of the materials generated asphyxiants, irritants, and airborne carcinogenic species that could be potentially debilitating. The combination and concentrations of gases produced depended on the base chemistry of the material:
  - All of the materials resulted in water, carbon dioxide and carbon monoxide.
  - Styrene based materials led to formation of benzene, phenols, and styrene.
  - Vinyl compounds led to formation of acid gases (HCl and HCN) and benzene.
  - Wood based products led to formation of formaldehyde, formic acid, HCN, and phenols.
  - Roofing materials led to formation of sulfur gas compounds such as sulfur dioxide and hydrogen sulfide.

---

<sup>1</sup> The reader may note that this trend is consistent with results reported in the Smoke Characterization Report; however, these conclusions were drawn solely on the materials investigated for this project, which total more than twice as many as investigated in the Smoke Characterization Report, all of which are different.

### 8.3 LARGE-SCALE TESTS

- The same asphyxiants, irritants, and airborne carcinogenic species were observed as in material-level tests supporting the premise that gases generated in large-complex fires arise from individual component material contributions.
- Ventilation was found to have an inverse relationship with smoke and gas production such that considerably higher levels of smoke particulates and gases were observed in contained fires than uncontained fires, and the smoke and gas levels were greater inside of contained structures than outside.
  - Recommended exposure levels (IDLH, STEL, TWA) were exceeded during fire growth and overhaul stages for various gases (carbon monoxide, benzene, formaldehyde, hydrogen cyanide) and arsenic.
  - Smoke and gas levels were quickly reduced by suppression activity however they remained an order of magnitude greater than background levels during overhaul.
  - 99+ % of smoke particles collected during overhaul were less than 1 micron in diameter. Of these 97+ % were too small to be visible by the naked eye suggesting that “clean” air was not really that clean.
- While not the focus of this research, it should be noted that the ion alarm activated sooner than the photoelectric alarm in every room fire scenario (living rooms, bedroom, kitchen). This is consistent with results reported in the Smoke Characterization Report for model flaming fire tests conducted in the smoke alarm fire test room. Carbon monoxide alarm activation lagged behind both ion and photoelectric alarms, furthermore.

### 8.4 FIELD EVENTS & CONTROLLED FIELD TESTS

- Concentrations of certain toxic gases were monitored at field events during the course of normal firefighter duties. These results were analyzed to determine:
  - Average gas concentrations and exposures calculated for the field events, which may be useful for estimating total exposure from repeated exposures during a firefighter’s career.
  - Potential gas concentration and exposures calculated for the field events, which may be useful for planning firefighter preparedness.
  - Gas exposures in excess of NIOSH IDLH, STEL, and OSHA TWA. These were repeatedly observed at the monitored field events. Carbon monoxide concentrations most often exceeded recommended exposure limits; however instances were observed where other gases other than carbon monoxide exceeded recommended exposure limits yet carbon monoxide did not.
- Collected smoke particulates contained multiple heavy metals including arsenic, cobalt, chromium, lead, and phosphorous.
  - The NIOSH STEL concentration for arsenic was exceeded at one fire and possibly at a second. Gas monitors would not provide warning for arsenic exposure.
- Chemical composition of the smoke deposited and soot accumulated on firefighter gloves and hoods was virtually the same except concentrations on the gloves were 100X greater than the hoods.
  - Deposits contained lead, mercury, phthalates and PAHs.
- Carbon monoxide monitoring may provide a first line of gas exposure defense strategy but does not provide warning for fires in which carbon monoxide does not exceed recommended limits but other gases and chemicals do.



- The OP-FTIR was difficult to successfully implement in the field and even for the controlled field events in passive mode.
    - While the OP-FTIR could be set-up in less than 2 minutes, it typically took as long as 5 to 10 minutes to start data collection. This time frame is too long when compared to the aggressive time frames of fire suppression.
- Poor thermal contrast led to insufficient signal-to-noise ratios

## 8.5 HEALTH IMPLICATIONS

- Multiple asphyxiants (e.g. carbon monoxide, carbon dioxide and hydrogen sulfide), irritants (e.g. ammonia, hydrogen chloride, nitrogen oxides, phenol and sulfur dioxide), allergens (e.g. isocyanates), and chemicals carcinogenic for various tissues (e.g. benzene, chromium, formaldehyde and polycyclic aromatic hydrocarbons) were found in smoke during both suppression and overhaul phases. Carcinogenic chemicals may act topically, following inhalation, or following dermal absorption, including from contaminated gear.
  - Concentrations of several of these toxicants exceeded OSHA regulatory exposure limits and/or recommended exposure limits from NIOSH or ACGIH.
  - Exposures to specific toxicants can produce acute respiratory effects that may result in chronic respiratory disease.
- High levels of ultrafine particles (relative to background levels) were found during both suppression and overhaul phases.
  - Exposure to particulate matter has been found to show a positive correlation with increased cardiovascular morbidity and mortality for general population studies.
  - The high efficiency of ultrafine particle deposition deep into the lung tissue can result in release of inflammatory mediators into the circulation, causing toxic effects on internal tissues such as the heart. Airborne toxics, such as metals and polycyclic aromatic hydrocarbons, can also be carried by the particles to the pulmonary interstitium, vasculature, and potentially subsequently to other body tissues, including the cardiovascular and nervous systems and liver.
- Interactions between individual exposure agents could lead to additive or synergistic effects exacerbating adverse health effects.
- Long-term repeated exposure may accelerate cardiovascular mortality and the initiation/progression of atherosclerosis.

## **CHAPTER 9: ACKNOWLEDGEMENTS**

This research was funded by the Department of Homeland Security AFG Fire Prevention & Safety program under grant number EMW-2007-FP-02093 and conducted jointly by Underwriters Laboratories Inc, the Chicago Fire Department, and the University Of Cincinnati College Of Medicine. The authors wish to express their gratitude to the fine men and women of the Chicago Fire Department and the staff of Underwriters Laboratories who have contributed to and worked on this project.

## **APPENDIX A: LITERATURE STUDY RESULTS**

### **A.0 PURPOSE OF THE SEARCH**

This fire research study fills gaps identified in previous studies on fire fighters' exposure to combustion products. The study focuses on gas effluent and smoke particulates generated during residential structure and automobile fires and subsequent contact exposure resulting from residual contamination from personal protective equipment. Exposure to gas and particulates has been linked to acute and chronic effects resulting in increased fire fighter mortality and morbidity (higher risk of specific cancers and cardiovascular disease).

This project will investigate and analyze the combustion gases and particulates generated from three scales of fires: residential structure and automobile fires; simulated real-scale fire tests; and material based small-scale fire tests. Working in collaboration with University of Cincinnati College of Medicine, the data will be reviewed to assess the potential adverse health effects of the gas effluents and smoke particles to the firefighter professional.

This research has the potential to benefit the target audiences including both professional and volunteer fire services and allied safety organizations across the United States. The information developed from this research will provide a valuable background to interpret fire hazards and can be used by: (a) the medical community to advance their understanding of the epidemiological effects of smoke exposure; (b) first responders to develop situational assessment guidelines for self-contained breathing apparatus (SCBA) usage and personal protection equipment cleaning regimen; (c) organizations such as NIOSH and NFPA to develop new test method standards and performance criteria for respirators used by first responders and the care and maintenance of personal protection equipment.

This literature study was conducted to review and collect the current data and research on firefighter exposures to smoke both during suppression as well as the overhaul stages of the fire, their potential for cancer or other health problems and any other relevant research that would help guide the path of the research. The search topics covered research on overhaul, firefighter cancer, firefighter pulmonary and cardiovascular problems, smoke characterization, wildland fires, vehicle fires, Fourier Transform Infrared Spectrometry and other topics relevant to our study. Documents were collected from universities, fire service publications, medical publications, fire research journals, national organizations and government agencies. There were many document types to include scientific reports, articles, books, standards, presentation materials, web sites and many others.

### **A.1 SUMMARY OF THE SEARCH**

The search was composed of two main activities: a general internet search and a technical publication search. The internet search used Google and site-specific search engines to find articles, reports, proceedings, presentations, and other documents related to the topic. The technical publication search included electronic databases of periodicals, books, proceedings, etc. The Illinois Fire Services Institute utilized the University of Illinois library resources to obtain copies of documents not electronically available and any other documents that may have added to the search. Additionally, after a review of the documents, relevant references were specifically added to the search.

Once gathered, all of the documents were reviewed for relevance and sorted by topic area. A total of approximately 300 documents were reviewed and narrowed down to 120 relevant documents. These documents were logged into a database and reviewed further for information pertinent to this study. Information identifying the 120 most relevant documents is located in the document list in APPENDIX A-1: DOCUMENT LIST. Furthermore, a detailed review of the 120 documents narrowed the list down to the 20 most relevant documents which are expanded upon in APPENDIX A-2: REFERENCES AND SUMMARIES OF MOST RELEVANT DOCUMENTS. Each of these entries includes a full reference, an abstract or introduction of the document and a review including information important to the direction of the study. Further appendix material is included for those documents that have important tables or figures with summaries of data collected, methodologies used or other important information for our study.

## **A.2 TOPIC AREAS**

Due to the complexity of this study a number of topic areas needed to be reviewed to see what research has already been done in the fields that all contribute to the success of this project. A description of each of the topic areas and how it fits into the total project is provided below.

- **Overhaul**

This is the topic area that we are most concerned with. Overhaul is the practice of searching a fire scene to detect hidden fires or sparks that may rekindle. This is the point in the fire where firefighters may remove their breathing apparatus leaving them vulnerable to an atmosphere with numerous products of combustion. The measurements taken of this atmosphere and the methods of measurement in previous studies were of utmost importance. 16 documents were found as relevant and reviewed.

- **Firefighter Cancer**

This is the potential end result of the exposures of the firefighters to harmful atmospheres during their careers. We examined 14 documents on this topic to see what evidence there was to link fire fighter exposures to cancer rates.

- **Firefighter Lung and Heart**

Cancer is not the only concern when it comes to being exposed to harmful environments. We identified and examined 20 documents that covered different aspects of pulmonary and cardiac problems in firefighters.

- **Smoke Characterization**

Many studies have been conducted to determine the various characteristics of smoke and its components and toxicology. This research was reviewed to see the different measurements and yields that have been done with various sources of smoke production. Thirteen documents were reviewed on this subject.

- **FTIR**

An Open Path Fourier Transform Infrared Spectrometer was a measurement device used in our experiments to identify key smoke components. Utilizing this device in the field to

record data has not been done often so 12 documents were reviewed on this topic to make sure it was used properly and effectively.

- **Wildland Smoke**

More research has been done in the wildland smoke inhalation area than in the overhaul stage of a fire to identify the exposure to the firefighters breathing potentially harmful smoke. Wildland fires are often fought without the protection of a self-contained breathing apparatus (SCBA). Seven documents were reviewed in this area to try to learn lessons on the measurement techniques or conclusions drawn.

- **Vehicle Fire Smoke**

Another type of incident where firefighters may be exposed to smoke without the protection of a SCBA is a vehicle fire. We reviewed 9 documents that highlighted the components of the smoke produced from burning vehicles.

- **Other Relevant Documents**

There were 29 other documents that were relevant to the study but did not fit into one of these specific topic areas. These documents included statistical reports, documents on SCBA, studies on other firefighter exposures, etc.

### **A.3 SEARCH RESULTS**

#### **A.3.1 Problem**

Currently gaps exist in the knowledge of the size distribution of smoke particles generated in fires and the absorbed chemicals on the particles' surfaces. Some gas effluents may condense on the protective equipment and exposed skin leaving an oily residue or film. These factors can pose a significant threat to firefighter health (e.g., skin, eye, inhalation). More research is required to document the gas effluent composition from fires involving residential construction and contents.

The need for SCBA use by firefighters is obvious and firefighters are trained to use the equipment when they are exposed to high temperatures and carbon monoxide levels. However SCBA are not typically used during the overhaul phase, when the direct fire threat has diminished. During these operations, firefighters may inhale unknown concentrations of residual gases and/or smoke particles with absorbed chemicals and may be exposed to condensed oily residue. Depending upon the smoke particle sizes, they may remain entrenched in respiratory and pulmonary systems and pose long-term threat to firefighters. The gases, condensed liquids and smoke particulates generated during the various stages of fire growth, as well as during firefighting efforts, have not been well characterized for residential fires.

Smoke deposits and condensed residues accumulate on firefighting garments and skin from fire exposure and subsequent overhaul operations and remain on firefighter personal protection equipment and skin until cleaned. These contaminants may lead to further exposure to firefighters and other individuals that come in contact with the firefighter personal protection equipment.

### A.3.2 Previous Research Methodology

**Anthony [2007]** – Laboratory experiments with a test chamber to simulate overhaul smoke conditions to evaluate the ability of air purifying respirator cartridges to protect firefighters. Measurements included: CO (MSA Passport personal monitor), 91 other chemical compounds using standard test methods [aldehydes (EPA T011, 15 compounds), methylisothiocyanate (OSHA 2), PAHs (NIOSH 5506, 16 compounds), hydrocarbons (MC-MS scans EPA T01/T02, 59 compounds), Particle concentrations (personal DataRams), Respirable dust (gravimetric NIOSH 0500), Free Radicals (37mm cassettes using PVC filters NIOSH Morgantown)]

**Austin [2001]** – Field experiments in which firefighters collected samples from 9 structural fires with Summa canisters when they felt SCBA would be removed. Measurements included: Gas chromatography/mass spectral detection (144 target compounds in selected ion mode and scan mode)

**Bolstad-Johnson [2000]** - Field experiments in which Phoenix firefighters collected samples during the overhaul stage from 25 structural fires. Measurements Included: Personal samples were collected with pumps for aldehydes (DNPH tube); benzene (Charcoal tube); toluene (charcoal tube); ethyl benzene (charcoal tube); xylene (charcoal tube); hydrochloric acid (ORBO 53 tube); polynuclear aromatic hydrocarbons (PTFE filter/ORBO 43 tube); respirable dust (PVC filter); and hydrogen cyanide (soda lime tube). 4-gas meter (Metrosonics) Gas analyzers monitored carbon monoxide (CO), HCN, nitrogen dioxide (NO<sub>2</sub>), and sulfur dioxide (SO<sub>2</sub>). Area samples were collected for asbestos (0.8 μm, 25mm, MCE filter), metals (Cd, Cr, Pb) (0.8 μm, 37mm, MCE filter), and total dust (5 μm, 37mm, PVC filter).

**Brandt-Rauf [1988]** - Field experiments in which Buffalo firefighters collected samples during the suppression and overhaul stage from 14 fires (26 samples). Measurements included: Carbon monoxide, hydrogen chloride, hydrogen cyanide, sulphur dioxide, Benzene and Formaldehyde (Calorimetric detector tubes). Dichlorofluoromethane, methylene chloride, trichloroethylene, chloroform, perchloroethylene, toluene, and trichlorophenol (charcoal sorbent tubes). GC/MS analysis was used. Particulate samples (glass fiber filters, 5 samples). Temperature monitoring (color detector strips).

**Burgess J [2001]** - Field experiments in which 26 Phoenix and 25 Tucson firefighters conducted overhaul operations. The Phoenix firefighters connected a filter to their face piece in 7 actual fires and 2 training fires and the Tucson firefighters used no protection during 5 actual fires and 2 training fires. After exposures blood was drawn and tested and lung function was tested. Measurements included: Dräger Miniwarn four-gas direct-read meters (configured to detect carbon monoxide, nitrogen dioxide, sulfur dioxide, and methane) and Pac III single-gas meters (configured for hydrogen cyanide). Sorbent tube samples were collected for aldehydes (acetaldehyde, acrolein, benzaldehyde, formaldehyde, glutaraldehyde, isovaleraldehyde), benzene, hydrogen chloride, and sulfuric acid. Hydrogen cyanide was measured with sorbent tubes in Phoenix only. In Tucson, lead, cadmium, and chromium were measured in a personal total dust sample. Respirable dust was sampled using personal cyclone samplers (Mine Safety Appliance, Pittsburgh, PA) equipped with pre-weighed polyvinyl chloride filters.

**Burgess WM [1977]** - Field experiments in which Boston firefighters conducted suppression and overhaul operations in 72 structure fires over 10 months. Measurements included: oxygen concentration and carbon monoxide concentrations (personal air sampler).

**Gold [1978]** - Field experiments in which Boston firefighters conducted suppression and overhaul operations and obtained 90 samples. Measurements included: Oxygen (Bag sample/paramagnetic analyzer at firehouse), Carbon Dioxide (bag sample/detectortubes at firehouse), Carbon Monoxide (Bag sample/Ecolyzer at firehouse), Nitrogen Dioxide (13X molecular sieves impregnated with triethanolamine), Hydrogen Chloride (sieves impregnated with triethanolamine), Hydrogen Cyanide (30-60 mesh Ascarite) and Particulate content (gravimetric/25mm glass fibers).

**Jankovic [1991]** - Field experiments in which firefighters collected samples during knockdown and overhaul operations on 22 fires (6 training, 15 residential, 1 automobile) with measurements inside and outside their SCBA mask. Measurements included: Numerous gases (tedlar bags/on-sire FTIR), Hydrochloric acid (silica gel tube/GC), Hydrofluoric acid (silica gel tube/GC), Nitric acid (silica gel tube/GC), Sulphuric acid (silica gel tube/GC), Hydrogen Cyanide (soda lime tube/Konig reaction), Acetaldehyde (polymer tube/GC/FID), Formaldehyde (polymer tube/GC/FID), Acrolein (polymer tube/GC FID), VOCs (Charcoal tube/GC/FID/Spectrometry), Fibres (cellulose ester filter/phase contrast microscopy), Bulk materials (hand collected/polarized light microscopy), Particle size distribution (cascade impactor/gravimetric), PNAs (Teflon folter/GC/FID), CO (direct reading meter/electrochemical cell).

**Jankovic [1993]** - Field experiments in which firefighters collected samples during knockdown and overhaul operations on 22 fires (6 training, 15 residential, 1 automobile) with measurements inside and outside their SCBA mask. Measurements included: Short-lived reactive species (chemiluminescence field measurement) Long-lived free radicals (electron spin resonance spectroscopy)

**Kinnes [1996]** - Field experiments in which fire investigators sampled the environment after 5 fires in the investigation stage of the fire after overhaul (2 actual and 3 experiments). Measurements included: Hydrogen Cyanide (soda lime tube/spectrophotometry), Inorganic acids (ORBO 53 sorbent tubes/ ion chromatography), Aldehydes (XAD -2 sorbent tubes/ GC-FID), Formaldehyde (Impinger/spectroscopy), PAHs (Zeflour filter on ORBO 42 sorbent tube/HPLC), VOCs (thermal desorption tubes/ GC/MS), Solvents (charcoal sorbent tube/GC-FID), metals (MCE filter/ICP), Total particulate (PVC filter/gravimetric), Respirable particulate (PVC filter/gravimetric), Grimm Portable Dust Monitoring, Elemental/organic carbon (quartz fiber filters/optical)

**Lowry [1985]** - Field experiments in which Dallas area firefighters collected samples from 72 residential fires in areas with light to dense smoke with low thermal energy. Measurements included: Carbon monoxide, hydrogen cyanide, formaldehyde and acetaldehyde (bag samples/infrared gas analyzer), Personal samplers (MSA) – CO, HCl, HCN, Formaldehyde (calorimetric tubes), organics (GS/MS)

**Treitman [1980]** - Field experiments in which Boston firefighters wore a personal sampling system at over 200 fires. Measurements included: Measurements included: Acrolein (Activated 13X molecular sieves/GC), benzene (activated charcoal/GC), Carbon Dioxide (bag sample/detectortubes at firehouse), Carbon Monoxide (Bag sample/Ecolyzer at firehouse), Nitrogen Dioxide (13X molecular sieves impregnated with triethanolamine), Hydrogen Chloride (sieves impregnated with triethanolamine), Hydrogen Cyanide (30-60 mesh Ascarite/calorimetric) and Particulate content (gravimetric/25mm glass fibers).

### **A.3.3 Previous Research Results**

Numerical results from each of the studies described above can be found in the appendix in tabular format. Many of the tables compare data from previous research and provide further detail as to the methodology used and the uncertainty of the measurements. Some of the results have acute health effects associated with the different gases or species measured and references to published threshold limits for the respective exposure times.

### **A.3.4 Identified Research Focus Areas**

Measurements have been taken and documented for all stages of a fire that firefighters may be exposed to, fire attack or knockdown, overhaul and investigation, as well as wildland fires and vehicle fires. There are good sets of data to compare overhaul environment data against as well as a few different methodologies to compare results such as personal sampling, bagged samples that are analyzed outside of the environment and area sampling. There is no firefighting data to which to compare the OP-FTIR data against but there have been measurements taken in other fields such as the flare document reviewed below that has a comprehensive sensitivity analysis to which to learn from. None of the studies make any measurements from deposits that may be found on protective clothing.

There have been very comprehensive studies done that link components found in smoke to cancer and there have been numerous studies that have identified firefighters as statistically being at a higher risk of cancers as well as coronary and pulmonary problems. There is not a strong link between the smoke experiments and actual cases of firefighter cancer. This study will help solidify that missing link.

Conclusions of the previous studies indicate, “future studies should be expanded to include industrial fires and sampling of polar VOCs”, “additional health-based studies on the use of APR’s during overhaul should be used to confirm their effectiveness”, “further study is necessary to validate and expand these results, it will be desirable to correlate this information on exposure with health outcomes and the morbidity and mortality experience of firefighters”, “future research needs are in the areas of health effects for firefighters from overhaul, particulate characterization in overhaul and detector response in the overhaul environment”, “increase the time period between extinguishment and overhaul or continue the use of the SCBA for overhaul is recommended”, “it is impossible for firefighters to anticipate the conditions under which breathing apparatus must be used. Until a suitable instrument is available to monitor the exposure, breathing apparatus should be used continually at structural fires.”, “The exposures experienced by firefighters in this study might therefore differ from those in newer residential or industrial areas. Hence, more widespread sampling is necessary to establish the general applicability of the results.”, “The presence of these radicals, at a time when firefighters are not



wearing respiratory protection, may have chronic toxicological implications. Association of these radicals with respirable particles would allow them to penetrate deeply into the lungs where lung injury may occur.”, “the fires sampled in the study were predominantly structural in nature. Other situations, such as fires involving chemicals, train tunnels, vehicles and brush would probably present an entirely different contaminant profile.”, “wildfire smoke may cause acute lung injury. Since particle size and surface area of the smoke exposure are significant factors in radical generation and particle deposition, particle size should be considered when developing protective strategies.”, “Our results confirm previous findings of an elevated relative risk for multiple myeloma among firefighters. In addition, a probable association with non-Hodgkin lymphoma, prostate, and testicular cancer was demonstrated.”, “Of the 804,000 eligible records, 3,659 had firefighting as their occupation. Firefighting was associated with testicular cancer, melanoma, brain cancer, esophageal cancer, and prostate cancer.”

**APPENDIX A-1: DOCUMENT LIST****OVERHAUL (16)**

| <b>Primary Author</b> | <b>Title</b>   | <b>Association</b>                    | <b>Year</b> |
|-----------------------|--|---------------------------------------|-------------|
| Anderson, David       | Firefighters' health and safety during overhaul operations   | Advanced Environmental Services, Inc. | 1997        |
| Anthony, T. Renee     | Method Development Study for APR Cartridge Evaluation in Fire Overhaul Exposures                             | University of Arizona                 | 2007        |
| Austin, C.C.          | Characterization of Volatile Organic Compounds in Smoke at Municipal Structural Fires                        | McGill University                     | 2001        |
| Bolstad-Johnson, Dawn | Characterization of Firefighter Exposures During Fire Overhaul   | City of Phoenix                       | 2000        |
| Brandt-Rauf, Paul     | Health hazards of fire fighters: exposure assessment   | Columbia University                   | 1988        |
| Bryant, Rodney        | Real-Time Particulate Monitoring –Detecting Respiratory Threats for First Responders: Workshop Proceedings   | NIST                                  | 2007        |
| Burgess, Jeffery      | Adverse Respiratory Effects Following Overhaul in Firefighters   | University of Arizona                 | 2001        |
| Burgess, Jeffery      | Minimum protection factors for respiratory protective devices for firefighters.                              | University of Arizona                 | 1977        |
| Dunn, Vincent         | Salvage and Overhaul Operations  | FDNY (ret)                            | 2004        |
| Gold, Avram           | Exposure of firefighters to toxic air contaminants   | Harvard School of Public Health       | 1978        |
| Hester, Stephen       | The "Other" Occupational Hazard  | Great Falls (MT) Fire Rescue Dept.    | 2006        |
| Jankovic, John        | Environmental Study of Firefighters  | NIOSH                                 | 1991        |
| Jankovic, John        | Measurement of Short-Lived Reactive Species and Long-Lived Free Radicals in Air Samples From Structure Fires | Martin Marietta Energy Systems        | 1993        |
| Kinnes, Gregory       | Health Hazard Evaluation Report 96-0171-2692   | ATF                                   | 1998        |
| Lowry, William        | Studies of Toxic Gas Production During Actual Structural Fires in the Dallas Area                            | Institute of Forensic Sciences        | 1985        |
| Schnepf, Rob          | Smoke: Perceptions , Myths and Misunderstandings   | Cyanide Poisoning Treatment Coalition | 2006        |
| Treitman, Robert      | Air Contaminants Encountered by Firefighters   | Harvard School of Public Health       | 1980        |

**FIREFIGHTER CANCER (14)**

| <b>Primary Author</b> | <b>Title</b>  | <b>Association</b>   | <b>Year</b> |
|-----------------------|---|--|-------------|
| Baris, Dalsu          | Cohort Mortality Study of Philadelphia Firefighters                             | National Cancer Institute                                    | 2001        |
| Bates, Michael        | Registry-Based Case-Control Study of Cancer in California Firefighters          | University of California Berkely                             | 1986        |
| Editor                | Fighting Fires. Fighting Cancer.  | International Fire Fighter                                   | 2008        |
| Enterline, Philip     | Differential mortality from lung cancer by occupation                           | US Public Health Service                                     | 1963        |
| Feuer, Elizabeth      | Mortality of Police and Firefighters in New Jersey                              | New Jersey State Department of health                        | 1986        |
| Fischer, L.J.         | Evaluation of the Risk of Cancer among Fire Fighters                            | Michigan Environmental Science Board                         | 1999        |
| Golden, A             | The risk of cancer in firefighters  | Mount Sinai School of Medicine                               | 1995        |
| Golka, Klaus          | Fire Fighters, Combustion Products, and Urothelial Cancer                       | Institut für Arbeitsphysiologie an der Universität Dortmund  | 2008        |
| Haas, Nelson          | Latent Health Effects in Firefighters   | Department of Occupational Health, Newport, VT               | 2003        |
| Hansen, Eva           | A cohort study on the mortality of firefighters                                 | Institute of Community Health, University of Odense, Denmark | 1990        |
| Kang, Dongmug         | Cancer Incidence Among Male Massachusetts Firefighters, 1987–2003               | National University School of Medicine, Busan, Korea         | 2008        |
| LeMasters, Grace      | Cancer Risk Among Firefighters: A review and Meta-analysis of 32 Studies        | University of Cincinnati                                     | 2006        |
| Sjogren, Bengt        | RE: Mortality in Florida Professional Firefighters, 1972–1999                   | Karolinska Institutet, Stockholm                             | 2006        |
| White, John           | Developing a Cancer Prevention Program For the Arlington County Fire Department | Arlington County Fire Department                             | 2001        |

**FIREFIGHTER LUNG AND HEART (20)**

| <b>Primary Author</b>  | <b>Title</b>   | <b>Association</b>                                | <b>Year</b> |
|------------------------|--|---|-------------|
| Barnard, R James       | Near-Maximal ECG Stress Testing and Coronary Artery Disease Risk Factor Analysis in Los Angeles City Fire Fighters | University of California                          | 1975        |
| Bates, John            | Coronary Artery Disease Deaths in the Toronto Fire Department  | Toronto Fire Department                           | 1987        |
| Burgess, Jeffrey       | Longitudinal Decline in Lung Function: Evaluation of Interleukin-10 Genetic Polymorphisms in Firefighters          | University of Arizona                             | 2004        |
| Burgess, Jeffrey       | Serum Pneumoproteins: A Cross-Sectional Comparison of Firefighters and Police                                      | University of Arizona                             | 2003        |
| Douglas, DB            | Pulmonary function of London firemen   | TUC Centenary Institute of Occupational Health    | 1985        |
| Dueñas-Laita,, Antonio | Heart Disease Deaths among Firefighters  | Hospital Universitario Río Hortera, Spain         | 2007        |
| Geibe, Jesse           | Predictors of On-Duty Coronary Events in Male Firefighters in the United States                                    | Harvard Medical School                            | 2008        |
| Josyula, Arun          | Cytokine Genotype and Phenotype Effects on Lung Function Decline in Firefighters                                   | University of Arizona                             | 2007        |
| Kales, Stefanos        | Emergency Duties and Deaths from Heart Disease among Firefighters in the United States                             | Harvard Medical School                            | 2007        |
| Kales, Stefanos        | Firefighters and on-duty deaths from coronary heart disease: a case control study                                  | Harvard Medical School                            | 2003        |
| Mastromatteo, E        | Mortality in City Firemen  | Toronto, Canada                                   | 1959        |
| Miedinger, David       | Diagnostic Tests for Asthma in Firefighters  | University Hospital, Basel, Switzerland           | 2008        |
| Miedinger, David       | Respiratory symptoms, atopy and Bronchial hyperactivity in professional firefighters                               | University Hospital, Basel, Switzerland           | 2007        |
| Peabody, Homer         | Pulmonary Function and the Fire Fighters   | Rees-Stealy Clinic Research Foundation            | 1976        |
| Peters, John           | Chronic Effect of Fire Fighting on Pulmonary Function  | Harvard School of Public Health                   | 1974        |
| Rosenstock, Linda      | Firefighting and Death from Cardiovascular Causes  | UCLA School of Public Health                      | 2007        |
| Sidor, Reinhard        | Prevalence Rates of Chronic Non-Specific Respiratory Disease in Fire Fighters                                      | Harvard School of Public Health                   | 1974        |
| Slutzker, AD           | Bronchiectasis and progressive respiratory failure following smoke inhalation                                      | University of Illinois at Chicago                 | 1989        |
| Sparrow, David         | The Effect of Occupational Exposure on Pulmonary Function  | Harvard Medical School                            | 1982        |
| Unger, Kenneth         | Smoke inhalation in firemen  | The University of Texas Medical School at Houston | 1980        |

**SMOKE CHARACTERIZATION (13)**

| <b>Primary Author</b>     | <b>Title</b>  | <b>Association</b>  | <b>Year</b> |
|---------------------------|---|---|-------------|
| Alarie, Yves              | Toxicity of Fire Smoke  | Graduate School of Public Health, Pittsburgh, PA              | 2002        |
| Babrauskas, Vytenis       | The Role of Bench-Scale Test Data in Assessing Real-Scale Fire Toxicity                 | NIST  | 1991        |
| Boettner, E.A.            | Analysis of the Volatile Combustion Products of Vinyl Plastics                          | University of Michigan  | 1969        |
| Comm. On Fire Toxicology, | Fire and Smoke: Understanding the Hazards   | National Research Council                                     | 1986        |
| Cornish, Herbert          | Experimental Toxicology of Pyrolysis and Combustion Hazards                             | University of Michigan  | 1975        |
| Fabian, Thomas            | Smoke Characterization Project  | UL  | 2007        |
| Hartzell, Gordon          | Toxic Products From Fires   | Southwest Research Institute                                  | 1983        |
| Montgomery, Ruth          | Comments on Fire Toxicology   | Haskell Laboratory for Toxicology                             | 1975        |
| Nevaizer, Julie           | Evaluation of Toxic Potency Values for Smoke from Products and Materials                | NIST  | 2004        |
| Qiyuan, Xie               | An Experimental Setup for Measurements of Stokes Scattering Matrixes of Smoke Particles | University of Science and technology of China                 | 2007        |
| Sumi, K                   | CBD 144. Toxic Gases and Vapours Produced at Fires                                      | NRCC  | 1971        |
| Sumi, K                   | CBD 197. Evaluating the Toxic Hazard of Fires   | NRCC  | 1978        |
| Terrill, James            | Toxic Gases from Fires  | Department of Medicine and Environmental Health, Monsanto Co. | 1978        |

**OTHER RELEVANT DOCUMENTS (29)**

| Primary Author                  | Title  | Association   | Year |
|---------------------------------|--|---|------|
| ACGIH                           | TLVs and BEIs Based on the Documentation of the Threshold Limit Values for Chemical Substances and Physical Agents & Biological Exposure Indices | American Conference of Governmental Industrial Hygienists | 2006 |
| Austin, CC                      | Municipal Firefighter Exposure Groups, Time Spent at Fires and Use of Self-Contained-Breathing-Apparatus   | University of Quebec (UTQR)                               | 2001 |
| Babrauskas, Vytenis             | Toxic Hazard From Fires: A Simple Assessment Method  | NIST  | 1993 |
| Burgess, Jefferey               | Rapid Decline in Sputum Il-10 Concentration Following Occupational Smoke Exposure  | University of Arizona                                     | 2002 |
| C2 Technologies                 | Firefighter Fatalities in the United States in 2007  | USFA  | 2008 |
| Capleton, Alexander             | An overview of occupational benzene exposures and occupational exposure limits in Europe and North America                                       | MRC Institute for Environment and Health                  | 2005 |
| Chaturvedi, Arvind              | Blood Carbon Monoxide and Hydrogen Cyanide Concentrations in the Fatalities of Fire and non-fire Associated Civil Aviation Accidents, 1991-1998  | Toxicology and Accident Research Laboratory, FAA          | 2001 |
| Cone, David                     | Threats to Life in Residential Structure Fires   | Yale University School of Medicine                        | 2008 |
| Cone, David                     | Noninvasive Fireground Assessment of Carboxyhemoglobin Levels in Firefighters  | Yale University School of Medicine                        | 2004 |
| Cook, Charles                   | Do We Really Need a Written Respiratory Protection Policy?   | Central Yavapai Fire District (NFA EFO)                   | 2003 |
| Dills, Russell                  | Evaluation of Urinary Methoxyphenols as Biomarkers of Woodsmoke Exposure   | University of Washington                                  | 2006 |
| Fahy, Rita                      | Firefighter Fatalities in the United States - 2007   | NFPA  | 2007 |
| Firefighter Handbook, Chapter 7 | Self-Contained breathing Apparatus   | Thomson Delmar  | 2004 |
| Fireman, Elizabeth              | Induced Sputum Assessment in New York City Firefighters Exposed to World Trade Center Dust   | Institute for Pulmonary and Allergic Diseases             | 2004 |
| Hansen, Sam                     | A Comprehensive Respiratory Protection Plan  | Vestavia Hills Fire and Rescue (NFA EFO)                  | 2002 |
| Hansen, Eva                     | A mortality Study of Danish Stokers  | University of Copenhagen, Denmark                         | 1992 |
| Karter, Michael                 | Fire Loss in the United State During 2006  | NFPA  | 2007 |
| Klitzman, Susan                 | Implications of the World trade Center Attack for the Public Health and Health Care Infrastructures  | Hunter College, City University of New York               | 2003 |
| Loke, Jacob                     | Carboxyhemoglobin Levels in Fire Fighters  | Yale University School of Medicine                        | 1976 |
| NFPA 1851                       | Standard on Selection, care and maintenance of protective ensembles for structural fire fighting and proximity fire fighting                     | NFPA  | 2008 |

**OTHER RELEVANT DOCUMENTS (29) – continued**

| <b>Primary Author</b> | <b>Title</b>  | <b>Association</b>                       | <b>Year</b> |
|-----------------------|---|--|-------------|
| NFPA 1852             | Standard on Selection, care and maintenance of Open-Circuit Self-Contained Breathing Apparatus (SCBA)   | NFPA                                     | 2002        |
| One Stop Data Shop    | U.S. Home Structure Fires   | NFPA                                     | 2005        |
| Pettit, Ted           | One Fire Fighter Dies of Smoke Inhalation, One Overcome by Smoke While Fighting an Attic Fire--New York                                       | NIOSH                                    | 1997        |
| Poller, Wolfgang      | Cardiovascular Manifestations of Carbon Monoxide Poisoning  | Charite-Universitätsmedizin Berlin       | 2006        |
| Slutzker, AD          | Bronchiectasis and Progressive respiratory failure following smoke inhalation   | University of illinois at Chicago        | 1989        |
| Stull, Jeffrey        | Firefighter Autopsy Protocol  | International Personnel Protection, Inc. | 2008        |
| Tridata               | The Economic Consequences of Firefighter Injuries and Their Prevention. Final Report.   | NIST/Tridata                             | 2005        |
| Wijngaarden, Edwin    | Critical Literature Review of Determinants and levels of Occupational Benzene Exposure for United States Community-Based Case-Control Studies | Applied Epidemiology Inc.                | 2003        |
| Wing, Kung            | Hydroxocobalamin for Acute Cyanide Poisoning in Smoke Inhalation  | Hong Kong Poison Information Centre      | 2008        |

**FTIR (12)**

| Primary Author   | Title  | Association  | Year |
|------------------|--|--|------|
| 40 CFR Part 58   | Ambient Air Quality Surveillance Siting Criteria for Open Path Analyzers   | U.S. EPA   | 1990 |
| Christian, T.J.  | Comprehensive laboratory measurements of biomass-burning emissions: 2. First intercomparison of open-path FTIR, PTR-MS, and GC-MS/ FID/ ECD  | University of Montana                                  | 2004 |
| Chu, P.M.        | The NIST Quantitative Infrared Database  | NIST   | 1999 |
| Goode, Jon       | Measurements of Excess O <sub>3</sub> , CO <sub>2</sub> , CO, CH <sub>4</sub> , C <sub>2</sub> H <sub>4</sub> , C <sub>2</sub> H <sub>2</sub> , HCN, NO, NH <sub>3</sub> , HCOOH, CH <sub>3</sub> COOH, HCHO and CH <sub>3</sub> OH in 1997 Alaskan Biomass Burning Plumes by Airborne Fourier Transform Infrared Spectroscopy (AFTIR) | University of Montana                                  | 2000 |
| Karl, T.G.       | The Tropical Forest and Fire Emissions Experiment: method evaluation of volatile organic compound emissions measured by PTR-MS, FTIR, and GC from tropical biomass burning   | National Center for Atmospheric Research, Boulder, USA | 2007 |
| Kroutil, Robert  | Emergency response chemical detection using passive infrared spectroscopy  | LANL/Center for Homeland Security Los Alamos, NM       | 2006 |
| Russwurm, George | Compendium of Methods for the Determination of Toxic Organic Compounds in Ambient Air  | U.S. EPA   | 1999 |
| URS Corporation  | Passive FTIR Phase I Testing of Simulated and Controlled Flare Systems   | Texas Commission on Environmental Quality              | 2004 |
| Yokelson, Robert | Trace gas measurements in nascent, aged, and cloud-processed smoke from African savanna fires by airborne Fourier transform spectroscopy (AFTIR) infrared  | University of Montana                                  | 2003 |
| Yokelson, Robert | The tropical forest and fire emissions experiment: laboratory fire measurements and synthesis of campaign data   | University of Montana                                  | 2008 |
| Yokelson, Robert | Open-path Fourier Transform Infrared Studies of large-scale laboratory biomass fires   | University of Montana                                  | 1996 |
| Yokelson, Robert | Emissions of formaldehyde, acetic acid, methanol, and other trace gases from biomass fires in North Carolina measured by airborne Fourier transform infrared spectroscopy  | University of Montana                                  | 1999 |



**WILDLAND SMOKE (7)**

| Primary Author    | Title  | Association                            | Year |
|-------------------|--|--|------|
| Aisbett, Brad     | Fighting with fire How bushfire suppression can impact on fire fighters' health                          | The University of Melbourne, Victoria  | 2007 |
| Barregard, L      | Experimental exposure to wood smoke: effects on airway inflammation and oxidative stress                 | Goteborg University, Goteborg, Sweden  | 2007 |
| De Vos, Annemarie | Effect of Protective Filters on Fire Fighter Respiratory Health During Simulated Bushfire Smoke Exposure | The University of Western Australia    | 2006 |
| Foote, Kenneth    | Determination of Toxic Material Penetrations for Wildland Respirator Filters                             | Lawrence Livermore National Laboratory | 1994 |
| Leonard, Stephen  | Particle size-dependent radical generation from wildland fire smoke                                      | NIOSH                                  | 2007 |
| Sharkey, Brian    | Health Hazards of Smoke  | USDA Forest Service                    | 1997 |
| Zelikoff, Judith  | The Toxicology of Inhaled Woodsmoke  | New York University School of Medicine | 2002 |

**VEHICLE FIRE SMOKE (9)**

| Primary Author   | Title   | Association               | Year |
|------------------|---|---------------------------|------|
| Janssens, Marc   | Development of a database of full-scale calorimeter tests of motor vehicle burns  | SWRI                      | 2008 |
| Mangs, Johan     | On the Fire Dynamics of Vehicles and Electrical Equipment   | VTT                       | 2004 |
| Ohlemiller, Tom  | An Overview of Fire Test Results On Certain Automotive Components   | NIST                      | 2001 |
| Sanrock, Jeffrey | Part 1: Full Scale Vehicle Fire Tests of a Control Vehicle and a Test Vehicle Containing an HVAC Module Made from Polymers Retardant Chemicals Containing Flame | General Motors            | 2002 |
| Sanrock, Jeffrey | Part 2B: Evaluation of a Fire Suppression System in a Full Scale Vehicle Crash Test and Static Vehicle Fire Tests - Underbody Gasoline Fires                    | General Motors            | 2003 |
| Sanrock, Jeffrey | Part 3: Full Scale Vehicle Fire Tests of a Control Vehicle and a Test Vehicle Containing an Intumescent Paint on its Underbody                                  | General Motors            | 2003 |
| Wichman, Indrek  | A Review of the Literature of Material Flammability, Combustion and Toxicity Related to Transportation  | Michigan State University | 2002 |
| Wichman, Indrek  | Theoretical and Experimental Study of Thermal Barriers Separating Automobile Engine and Passenger Compartments  | Michigan State University | 2001 |
| Wichman, Indrek  | Material flammability, combustion, toxicity and fire hazard in transportation   | Michigan State University | 2003 |

## **APPENDIX A-2: REFERENCES AND SUMMARIES OF MOST RELEVANT DOCUMENTS**

**1. Anderson, David, Webb, Terry. "Firefighters' health and safety during overhaul operations." Occupational Health & Safety; Aug 1997; 66, 8; ABI/INFORM Global pg. 44**

- Identifies that there are standards that govern suppression (NFPA 1500, NFPA 600, HAZWOPER, OSHA) but not overhaul.
- "Unfortunately, many exhausted firefighters, once the fire is extinguished, feel that they may no longer need to wear the heavy and clumsy self-contained breathing apparatus during these procedures. An IDLH situation may no longer exist, but a potential route of entry for toxic materials may still exist."
- Many dangers still present during overhaul, extreme temperatures, lacerations, punctures, slips/trips, poor visibility, and building collapse.
- The authors define the problem: "Thermal decomposition product residuals from fires can be extremely toxic. In a typical office, residential, or structural fire, many synthetic compounds are commonly found, including plastics, foams, insulation, and paints. Ceiling and wall materials may also contain toxics, and lead-based paint is often found in older construction. When these materials are involved in fires, they can liberate both gases and vapors, as well as aerosols, fibers (as from asbestos), possibly metal fumes, and other particles.

Thermal decomposition may produce carbon soot and complex organic molecules called pyrenes. Occasionally gases and vapors may be absorbed onto the surface of the particles, and when inhaled, may present a hazard from both the gas/vapor and the particulate phase.

Some of the gases and vapors that may be present include hydrogen cyanide, oxides of nitrogen, aldehydes (formaldehyde) and other organics, carbon monoxide, and isocyanates. Some of these have good warning properties, such as odors, and some have none. Exposures to any or all of these can produce toxic effects, both from an acute (immediate) effect and a chronic effect.

After the fire has been extinguished, carbon monoxide usually does not remain in the air for long periods (half-life = 28 seconds). It generally does not present a problem. In order to protect the respiratory system of the firefighters, full-face respirators equipped with organic vapor/acid gas chemical cartridges and a high efficiency particulate air filter may be considered. Training and planning may help to minimize some of the other hazards that may be present during overhaul operations.

With all of these potential hazards present during overhaul operations, local authorities are being challenged to define or standardize these procedures, which is a very difficult

task. Because of a lack of expertise in chemistry, toxicology, safety techniques, and so forth, some local agencies may not be able to address every concern in anything other than general terms.

Larger public service departments rely the safety officer assigned to the scene to make an intelligent decision when to remove PPE. This safety officer is normally trained and educated regarding hazardous situations, and the decisions are based on scientific data available, such as air monitoring results. “

Unfortunately, the monitoring devices are usually not specific for the multiple contaminants present, and they may give a false sense of security. Many public service fire departments are seeking better answers and are upgrading their equipment and training or relying on outside resources, such as health and safety consultants, if available. As always, budgetary constraints may dictate the level of equipment and resources that are available.

**2. Anthony TR, Joggerst P, James L, Burgess JL, Leonard SS and SHogren ES (2007) Method Development Study for APR Cartridge Evaluation in Fire Overhaul Exposures. *Am. OCCup. Hyg.*, Vol. 51, No.8, pp. 703-716.**

**Abstract:** In the US, firefighters do not typically wear respiratory protection during overhaul activities, although fitting multi-gas or chemical, biological, radiological and nuclear cartridges to supplied air respirator facepieces has been proposed to reduce exposures. This work developed a method to evaluate the effectiveness of respirator cartridges in smoke that represents overhaul exposures to residential fires. Chamber and penetration concentrations were measured for 91 contaminants, including aldehydes, polynuclear aromatic hydrocarbons, hydrocarbons and methyl isothiocyanate, along with total and respirable particulates. These laboratory tests generated concentrations in the range of field-reported exposures from overhaul activities. With limited tests, no styrene, benzene, acrolein or particulates were detected in air filtered by the respirator cartridge, yet other compounds were detected penetrating the respirator. Because of the complexity of smoke, an exposure index was determined for challenge and filtered air to determine the relative risk of the aggregate exposure to respiratory irritants. The primary contributors to the irritant exposure index in air filtered by the respirator were formaldehyde and acetaldehyde, with total hydrocarbons contributing only 1 % to the irritant index. Respirator cartridges were adequate to minimize firefighter exposures to aggregate respiratory irritants if the American Conference of Governmental Industrial Hygienists ceiling limit for formaldehyde is used (0.3 ppm) but not if National Institute for Occupational Safety and Health Recommended Exposure Limit (NIOSH REL) (0.1 ppm) is used, where three of five concentrations in filtered air exceeded the NIOSH REL. Respirator certification allows 1 ppm of formaldehyde to pass through it when challenged at 100 ppm, which may not adequately protect workers to current short-term exposure/ceiling limits. The method developed here recommends specific contaminants to measure in future work (formaldehyde, acrolein, acetaldehyde, naphthalene, benzene, total hydrocarbons as toluene and particulate mass) along with inclusion of additional irritant gases and hydrogen cyanide to finally evaluate whether air-purifying respirators reduce exposures to the aggregate gases/vapors present in overhaul activities.

**Review:**

- Contains a good background discussion of previous work.
- A grill was used to create smoke which filled a chamber. The smoke was monitored then pulled through a filter and the gas was measured on the other side of the filter for penetration.
- Smoke was created by burning wood/paper or wood/paper/foam/carpet.
- 2 filters were analyzed a multi-gas and a CBRN.
- The multi-gas was approved for atmospheres containing: ammonia, chlorine, chlorine dioxide, formaldehyde, hydrogen chloride, hydrogen fluoride, methylamine, organic vapors and sulfur dioxide, with a P100 designation that requires 99.97% protection against particulates.
- The CBRN was approved for all of the same as the multi-gas and added nitrogen dioxide and other warfare/nerve agents.
- The following were measured: CO readings were recorded inside the chamber using a Passport Five-Star personal alarm monitor (MSA, Pittsburgh, PA, USA). The MSA Passport was calibrated before use and zeroed in clean air prior to each burn test. Standard methods were used to collect and analyze 91 chemical compounds: aldehydes (EPA TO11, 0.7lpm, 15 compounds), methyl isothiocyanate (MITC) (Occupational Safety and Health Administration 2, 0.2 lpm), PAHs (NIOSH 5506, 2.0lpm, 16 compounds) and hydrocarbons in gas chromatography-mass spectroscopy (GC-MS) scans [Environmental Protection Agency (EPA) TO1/T02, 0.05 lpm, 59 compounds]. Samples for these components of smoke were analyzed by ESIS Environmental Health Lab in Cromwell, CT, USA, Industrial Hygiene Laboratory Accreditation Program (IHLAP) accredited. These respirator cartridges are certified to meet P100 (99.97% efficiency) NIOSH criteria. Thus, we did not anticipate particle penetration with these respirator cartridges. Particle concentrations in the chamber and in air filtered by the cartridge were monitored to evaluate the tightness of our seals.
- Two personal DataRAMs (*PDR*, Thermo Electron, Waltham, MA, USA) were used to measure realtime respirable dust concentrations inside the smoke chamber and downstream of the respirator cartridge. Using the manufacturer's directions, the *PDR* was calibrated prior to the study and zeroed in filtered air prior to each test. Gravimetric samples were also collected, with total dust using a closed-face 37-mm cassette with a 3.5-lpm sampling rate (NIOSH 0500) and respirable dust using SKC aluminum cyclones operated at 2.5 Lpm inside the chamber and a BGI cyclone in line with the *PDR*, operated at 2.6 lpm, in filtered air. All gravimetric dust samples were analyzed by Aerotech Laboratory in Phoenix, AZ, USA, IHLAP accredited. Free radical samples were analyzed by the NIOSH in Morgantown, WV, USA, to determine their capacity to generate carbon and hydroxyl radicals in the samples we collected. We prepared 37-mm cassettes using PVC filters and cellulose backup pad to collect total and respirable dust samples in conformance to NIOSH 0500/0600 gravimetric methods. Total radicals were collected using traditional closed-face 37-mm cassettes; respirable radicals used cyclones (SKC and BGI) to sample respirable particles. Immediately after sampling, these filters were removed from the 37-mm cassettes, transferred to Petri dishes and stored in the freezer at -20°C. When all samples were accumulated, they were transported on dry ice to NIOSH in Morgantown, WV, USA, for analysis. Electron spin resonance techniques (Leonard *et*

*ai.*, 2000) were used to investigate the reactivity of the materials trapped by the PVC filter. Spin trapping is the method of choice for detection and identification of free radical generation due to its specificity 708 T. R. Anthony *et al.* and sensitivity. Because the method is relatively new to industrial hygienists, a brief description of the analytical method is provided.

- Two types of radicals were evaluated: carbon and hydroxyl. The carbon radical is fairly stable and does not provide an indication of how reactive or toxic the material is but rather provides an idea of how much total 'smoke product' was on the sample filter. The hydroxyl radical identifies how much hydroxide radical is generated by the compounds collected on the sample filter following the addition of peroxide to the sample, yielding an indication of the radical potential of the smoke once it is inhaled. Data were reported as peak heights (mrn) from the electronic spin resonance (ESR) spectra per liter of sampled air (mrn l-1). Calibration of hyperfine couplings were measured (to 0.1 G) directly from magnetic field separation using potassium tetraperoxochromate (K<sub>3</sub>CrO<sub>8</sub>) and 1,1-diphenyl-2-picrylhydrazyl (DPPH) as reference standards (Buettner, 1987). Carbon radicals were measured directly by placing the filter into a 5-mrn quartz sample tube and placing it in the ESR cavity. Hydroxyl radicals were measured using the addition type reaction of a short-lived radical with a paramagnetic compound (spin trap) to form a relatively long lived free radical product (spin adduct), which can then be studied using conventional ESR. Reactants were mixed in test tubes in a final volume of 1.0 ml. The reaction mixture was then transferred to a flat cell for ESR measurement. The intensity of the signal indicates the amount of short-lived radicals trapped, and the hyperfine couplings of the spin adduct are characteristic of the original trapped radicals. Relative radical intensity was calculated using peak-to-peak measurement.
- All ESR measurements were conducted using a Bruker EMX spectrometer (Bruker Instruments Inc., Billerica, MA, USA) and a flat cell assembly. Acquisit software provided by Bruker Instruments Inc., was used for data acquisitions and analyses. Analyses were performed at room temperature and under ambient air. Even though there are currently no exposure limits to determine what measure of free radicals are 'safe' the free radical results can provide an indication of relative toxicity of the sampled smoke. A comparison of the amount of free radicals in the chamber and those that passed through the respirator provides an indication of the ability of air-purifying respirators to remove smoke-generated free radicals from the breathing air. With the exception of CO, all samples for this study were collected simultaneously both inside the chamber and in air filtered by the respirator cartridge. Data for six test burns were paired, by test, to evaluate contaminant penetration. CO measures were taken only within the smoke chamber, as these respirators do not protect against this gas.
- Document contains a chart that shows all of the concentrations of the 92 contaminants that they measured.
- There were only 6 tests.
- Formaldehyde and acrolein were present above their exposure limits.
- Glutaraldehyde should be measured in future experiments.
- Of the 59-component hydrocarbon scan only benzene at 8-30 times below the STEL and naphthalene at 200-1500 times below the STEL were measured. Total hydrocarbon should be analyzed.
- PAH tests were not useful because of the concentrations.

- Free radicals did not penetrate the respirator.
- There was a link between CO and respirable dust but not a strong one.
- Additional work is required to evaluate whether an acceptable air-purifying respirator cartridge is suitable for use in overhaul activities. The method developed here recommends specific contaminants to measure (formaldehyde, acrolein, acetaldehyde, naphthalene, benzene, total hydrocarbons as toluene and particulate mass), although additional irritants 716 T. R. Anthony *et al.* should be included in future studies (hydrogen chloride, hydrogen cyanide, nitrogen dioxide and sulfur dioxide) to better quantify the total irritant exposure index for the challenge gas and evaluate the performance of respirator cartridges currently under consideration by firefighters.

**3. Austin CC, Wang D, Ecobichon DJ, Dussault G. (2001) Characterization Of Volatile Organic Compounds In Smoke At Municipal Structural Fires. Journal of Toxicology and Environmental Health, Part A, 63:437–458.**

**Abstract:** The objective of this study was to characterize volatile organic compounds (VOCs) found at municipal structural fires in order to identify sources of long-term health risks to firefighters, which may be contributing factors in heart disease and cancer. Firefighters collected air into evacuated Summa canisters inside burning buildings at nine municipal structural fires under conditions where they judged that at least some firefighters might remove their self-contained breathing apparatus masks. Volatile organic compounds were identified and quantified for 144 target compounds using cryogenic preconcentration and gas chromatography/mass spectral detection (GC/MSD) methodology operating in selected ion monitoring mode. Samples were also analyzed in SCAN mode and examined for the appearance of substances that were not present in the instrument standard calibration mixture. The spectra of municipal structural fires were surprisingly similar and remarkable for their simplicity, which was largely due to the dominating presence of benzene along with toluene and naphthalene. Propene and 1,3-butadiene were found in all of the fires, and styrene and other alkyl-substituted benzene compounds were frequently identified. Similar “fingerprints” of the same 14 substances (propene, benzene, xylenes, 1-butene/2-methylpropene, toluene, propane, 1,2-butadiene, 2-methylbutane, ethylbenzene, naphthalene, styrene, cyclopentene, 1-methylcyclopentene, isopropylbenzene) previously identified at experimental fires burning various solid combustible materials were also found at municipal structural fires, accounting for 76.8% of the total VOCs measured. Statistically significant positive correlations were found between increasing levels of benzene and levels of propene, the xylenes, toluene, 1-butene/2-methylpropene, 1,3-butadiene, and naphthalene. Given the toxicity/carcinogenicity of those VOCs that were found in the highest concentrations, particularly benzene, 1,3-butadiene, and styrene, further investigation of VOC exposures of firefighters is warranted. Benzene, or its metabolic product *s*-phenylmercapturic acid in urine, was identified as a suitable chemical marker for firefighter exposure to combustion products.

**Review:**

- Details a number of studies that have found evidence of increased risk of cancer in firefighters.
- Utilize GC/Mass spectral detection to samples taken in evacuated Summa canisters.

- Benzene, toluene, 1,3-butadiene, naphthalene and styrene were found at higher concentrations.
- Has good table of potential firefighter exposures to combustion products from other studies and their methods. APPENDIX A-3: TABLES FROM [AUSTIN 2001]
- Samples were taken at 9 structure fires (7 mixed occupancy, an industrial fire, one smoldering structure fire)
- FF's were advised to take samples when they would normally take their mask off.
- There were 144 target compounds in the air samples obtained.
- There was a linear correlation between benzene and a ratio of selected VOCs.
- Of the 144 possible VOCs measured, 14 substances (propene, benzene, xylenes, 1-butene/2-methylpropene, toluene, propane, 1,2-butadiene, 2-methylbutane, ethylbenzene, naphthalene, styrene, cyclopentene, 1-methylcyclopentene, and isopropylbenzene) were found in proportionately higher concentrations, accounting for 76.8% (SD = ±10.4%) of the 123 VOCs found. "Fingerprints" of these 14 substances were found to be similar from fire to fire (Figure 4). Twenty-one substances, many of them chlorinated compounds present at levels less than 1 ppb (bromoform, bromotrichloromethane, *tert*-butylbenzene, carbon tetrachloride, dibromochloromethane, 1,2-dibromoethane, 1,2-dichlorobenzene, 1,3-dichlorobenzene, 1,1-dichloroethane, *c*-1,2-dichloroethene, *t*-1,2-dichloroethene, 1,1-dichloroethene, *c*/*t*-1,3-dichloropropene, *c*-1,3-dichloropropene, 2,2-dimethylhexane, hexachlorobutadiene, *c*-2-pentene, tetrachloroethene, 1,1,2-trichloroethane, trichloroethene, and 2,2,5-trimethylhexane), were excluded from the database.
- In spite of the small number of fire samples collected, the consistency of the results obtained indicates that there may be less variability in VOC exposures between fires than had been previously thought. Given the toxicity /carcinogenicity of those VOCs that were found in the highest concentrations, particularly benzene, 1,3-butadiene, and styrene, investigation of time-integrated personal exposures of firefighters to VOCs is warranted. Future studies should be expanded to include industrial fires and sampling of polar VOCs.

**4. Bolstad-Johnson DM, Burgess JL, Crutchfield CD et al. (2000) Characterization of firefighter exposures during fire overhaul. Am Ind Hyg Assoc J; 61: 636-41.**

**Abstract:** Previous studies have characterized firefighter exposures during fire suppression. However, minimal information is available regarding firefighter exposures during overhaul, when firefighters look for hidden fire inside attics, ceilings, and walls, often without respiratory protection. A comprehensive air monitoring study was conducted to characterize City of Phoenix firefighter exposures during the overhaul phase of 25 structure fires. Personal samples were collected for aldehydes; benzene; toluene; ethyl benzene; xylene; hydrochloric acid; polynuclear aromatic hydrocarbons (PNA); respirable dust; and hydrogen cyanide (HCN). Gas analyzers were employed to continuously monitor carbon monoxide (CO), HCN, nitrogen dioxide (NO<sub>2</sub>), and sulfur dioxide (SO<sub>2</sub>). Area samples were collected for asbestos, metals (Cd, Cr, Pb), and total dust. During overhaul the following exceeded published ceiling values: acrolein (American Conference of Governmental Industrial Hygienists [ACGIHT] 0.1 ppm) at 1 fire; CO (National Institute for Occupational Safety and Health [NIOSH] 200 ppm) at 5 fires; formaldehyde (NIOSH 0.1 ppm) at 22 fires; and glutaraldehyde (ACGIH 0.05 ppm) at 5 fires. In addition, the following exceeded published

short-term exposure limit values: benzene (NIOSH 1 ppm) at two fires, NO<sub>2</sub> (NIOSH 1 ppm) at two fires, and SO<sub>2</sub> (ACGIH 5 ppm) at five fires. On an additive effects basis, PNA concentrations exceeded the NIOSH recommended exposure limits (0.1 mg/M<sup>3</sup>) for coal tar pitch volatiles at two fires. Maximum concentrations of other sampled substances were below their respective permissible exposure limits. Initial 10-min average CO concentrations did not predict concentrations of other products of combustion. The results indicate that firefighters should use respiratory protection during overhaul. In addition, these findings suggest that CO should not be used as an indicator gas for other contaminants found in this atmosphere.

**Review:**

- 12 firefighters were trained and used to take measurements and they worked 12 hr shifts from the same fire station.
- Firefighters shadowed other firefighters performing overhaul activities.
- The sampling strategy involved both personal and area sampling.
- The personal sampling included 4 – 4 gas monitors (Metrosonics)
- The sampling pumps were held in a custom-made sleeve that fit over the air tank of the firefighter's self-contained breathing apparatus (SCBA) unit. The configuration of the sampling train included one pump dedicated to the collection of respirable dust, one pump dedicated to the collection of polynuclear aromatic hydrocarbons (PNAs), and one pump equipped with a low-flow adapter with adjustable flow rates for aldehydes and BTEX (benzene, toluene, ethyl benzene, and xylene), and a t-adapter to a hydrochloric acid sampling tube.
- The area sampling train consisted of two area sampling pumps for the area of origin and another area adjacent to the fire origin where overhaul activities occurred within the structure. The configuration of the area sampling train included one pump dedicated to the collection of airborne asbestos fibers and the other pump dedicated to the collection of total dust and metals (Cd, Cr, Pb). A t-adapter was used to connect the different types of media utilized for the collection of total dust and airborne metals samples. Preweighed 5.0 mm polyvinyl chloride and 0.8 mm mixed cellulose ester filters were used to collect total dust and metal samples, respectively. Flow rates were set for total dust near 4.0 L/min and ranged between 1.0 and 2.0 L/min for the metals samples.
- A minimum sampling time of 20 min was required to accommodate the various limits of detection for the analytical methods. All samples were submitted to an American Industrial Hygiene Association-accredited laboratory for analysis.
- There were 25 fires for complete analysis.
- Monitoring activities occurred at 14 houses, 6 apartments, and 5 commercial buildings. Not all analytes were collected at all fires due to equipment and sampling difficulties.
- During overhaul, the following analytes exceeded published ceiling values: acrolein (American Conference of Governmental Industrial Hygienists [ACGIH] 0.1 ppm) at 1 fire; CO (National Institute for Occupational Safety and Health [NIOSH] 200 ppm) at 5 fires; formaldehyde (NIOSH 0.1 ppm) at 22 fires; and glutaraldehyde (ACGIH 0.05 ppm) at 5 fires. In addition, the following analytes exceeded published short-term exposure limit (STEL) values: benzene (NIOSH 1 ppm) at two fires; NO<sub>2</sub> (NIOSH 1 ppm) at two fires; and SO<sub>2</sub> (ACGIH 5 ppm) at five fires.



- **Conclusion:** Concentrations of air contaminants during fire overhaul exceed occupational exposure limits. Without the use of respiratory protection, firefighters are overexposed to irritants, chemical asphyxiants and carcinogens. Therefore, respiratory protection is recommended during fire overhaul. SCBA should be used in atmospheres with CO concentrations above 150 ppm, and APRs may be used when CO concentrations are below 150 ppm. Finally, CO concentrations should not be used to predict the presence of other contaminants found in the overhaul environment.
- See APPENDIX A-4: TABLES FROM [BOLSTAD-JOHNSON 2000] for measurement results in tabular format.

**5. Brandt-Rauf, P. W., Fallon, L. F., Tarantini, T., Idema, C., and Andrews, L. (1988). Health hazards of firefighters: exposure assessment. *Br. J. Ind. Med.* 45:606–612.**

**Abstract:** There is growing concern over the detrimental health effects to firefighters produced by exposure to combustion byproducts of burning materials. To assess the types and levels of exposure encountered by firefighters during their routine occupational duties, members of the Buffalo Fire Department were monitored during firefighting activities with personal, portable, ambient environmental sampling devices. The results indicate that firefighters are frequently exposed to significant concentrations of hazardous materials including carbon monoxide, benzene, sulphur dioxide, hydrogen cyanide, aldehydes, hydrogen chloride, dichlorofluoromethane, and particulates. Furthermore, in many cases of the worst exposure to these materials respiratory protective equipment was not used owing to the visual impression of low smoke intensity, and thus these levels represent actual direct exposure of the firefighters. Many of these materials have been implicated in the production of cardiovascular, respiratory, or neoplastic diseases, which may provide an explanation for the alleged increased risk for these illnesses among firefighters.

**Review:**

- Study is on Buffalo, NY firefighters
- 51 firefighters in 2 stations participated over a 10 day period in January 1986. The sampling pumps used for the study were from Gilian Instruments, Inc, and combined high and low flow pumping systems. They are portable, battery powered units that draw air at a fixed rate either by maintaining constant flow for high flow (> 500 cc/ Portable personal sample pump with elapsed time indicator Schematic diagram of sampling pump with six stage variable orifice manifold and tube holder system carried by firefighters for personal ambient environmental monitoring during fires. min) or through constant pressure regulated by a variable orifice for low flow (1-500 cc/min). They include a programmable timer that can be used to start and stop the pump at preset intervals and a display timer to indicate total time of operation. The flow rate of the unit is calibrated by using a calibrated flow meter.
- Samples were collected during various stages of firefighter activities (rescue, fire control, overhaul). If respiratory protective equipment was being worn samples were collected outside the face pieces. The samples collected thus represented the potential inhalation exposure of the firefighters not wearing respiratory protection.
- Colorimetric detector tubes manufactured by Drager, Inc, were used in the pump manifold system to detect the presence of six compounds: carbon monoxide, hydrogen

chloride, hydrogen cyanide, sulphur dioxide, benzene, and formaldehyde. In addition to the colorimetric tubes, charcoal sorbent tubes were used to sample organic compounds present in the combustion environment; these tubes were desorbed after exposure and analysed by gas chromatography/ mass spectrometry (GC/MS) methodology. Also, cassettes containing 37 mm glass fibre filters were used to sample particulate matter encountered during firefighting activities; these were analysed for total particulates by weight before and after exposure. Ambient temperatures in the firefighters' occupational environment were monitored by using Thermotech T-500 temperature sensitive color detector strips. The strips have color indicators that turn black at predetermined temperatures. These strips were placed on the exterior of carrier packs or mounted on randomly selected firefighters' helmets.

- See Tables in APPENDIX A-5: TABLES AND FIGURES FROM [BRANDT-RAUF 1988] for numerical results.
- There were 14 fire events and CO and benzene when present were well in excess of the 8 hr TVL-TWA.
- All the particulate samples exceeded the TLV and one HCN exceeded the IDLH level. of 2 ppm.<sup>28</sup> Five glass fibre filtered particulate samples were obtained. Concentrations ranged from 10.1 to 344.4 mg/3, all exceeding the ACGIH TLV-TWA for nuisance particulates of 10 ppm.
- Heat monitoring results using the temperature sensitive color detector strips showed that all temperatures encountered were less than 200°F, the minimum detection limit of these strips.
- On the uncertainty of the Colorimetric tubes: The limitations of the technology used in this study must be recognized. Colorimetric detector tubes were selected because they are inexpensive and easy to use and thus would lend themselves to large scale use on a routine basis. These tubes, however, have problems with specificity and accuracy. Regarding specificity, the reaction mechanisms used for various tubes will rarely be restricted to only one substance. Although the manufacturers have tested for and reported the influence of common interfering substances on specific tubes, not all possible interferences have been tested. Considering the chemical mixture that is obviously emitted from a fire, it is quite possible that the length of colour stain developed on any given colorimetric tube will reflect the reaction of not only the contaminant of interest but also the effect of both positive and negative interferences from co-contaminants in the same environment. In general, positive interferences are more likely than negative ones. Thus it is possible that the concentrations of some of the contaminants reported on the basis of the colorimetric tubes are biased high. This was a known problem, for example, with the formaldehyde tube detection since other aldehydes that could be present in fires (acrolein, acetaldehyde) would be detected. Secondly, colorimetric detector tubes are not very accurate even under ideal conditions (approximately 25% of the tube concentration). As a check on this, we compared the concentrations for benzene as determined colorimetrically with that determined by GC/ MS analysis on a charcoal sorbent tube from the same fire (call number 12). Four firefighters in this fire were monitored for benzene using the colorimetric tube method; concentrations of benzene recorded were 0, 25, 33, and 50 ppm. Another firefighter was monitored during the same incident using the charcoal tube/GC/ MS method and his estimated benzene exposure was about 1 ppm. Such a wide discrepancy between the highest and lowest values obtained by the

colorimetric technique and between the values determined by the two different techniques may be attributed to many factors. For example, this may merely be indicative of the wide range of non-comparable exposure conditions encountered at any given fire. Nevertheless, it may also reflect the limited accuracy of the colorimetric techniques. In consideration of this and the potential for interferences from other chemicals in the emissions plume as noted above, it is probably best to consider the measured concentrations by colorimetric techniques to be approximations rather than accurate determinations. Future studies with more elaborate back up determinations including more concomitant charcoal sorbent/GC/MS assays will provide a clearer picture of the accuracy of colorimetric assays for routine field monitoring of firefighters.

- More research is needed, over a longer period of time and compared to morbidity and mortality in FFs.

**6. Bryant RA, Butler KM, Vettori RL, Greenberg PS. (2007) Real-Time Particulate Monitoring – Detecting Respiratory Threats for First Responders: Workshop Proceedings. NIST Special Publication 1051.**

**Abstract:** The overhaul of a fire scene is a stage of firefighting where respiratory protection is often disregarded due to the perception of low risk and the desire to remove the heavy and cumbersome self-contained breathing apparatus. The need for alternative options for respiratory protection that are fitted to the task and environment has been voiced by the firefighter community. Choosing the appropriate respiratory protection for individual events can only be accomplished with real-time information about the exposure hazards. Hand-held direct-reading particulate detectors have been used in other environmental monitoring applications, and it may be possible to transfer the technology to meet the needs of the firefighter.

The workshop on Real-Time Particulate Monitoring held at the National Institute of Standards and Technology (NIST) on 3-4 May 2007 brought together members of the fire service, particulate detector manufacturers, public health professionals, airborne particulate researchers, and standards organizations to discuss the need for better technology to assess the level of respiratory protection that is required for environments encountered by first responders. The program included invited speakers who presented information on characterization of respiratory threats during fire overhaul and the need for respiratory protection, performance needs and priorities for the fire service application, and state-of-the-art and recent developments in particulate detection. After the presentations, attendees divided into three breakout sessions, and each group responded to a predetermined set of questions related to the following topics: Research Needs, Performance Criteria, Standards, and Technological Advances.

The consensus of the workshop participants was that future research is needed to better understand the health effects of particulates on firefighters, to better characterize the particulates present during overhaul, and to better characterize the response of particulate detectors to the overhaul environment. Defining performance criteria to address first responder needs regarding data telemetry and logging, instrument operation and data interpretation, and the physical performance of the instrument were also areas of consensus.

The group also felt that developing standards for the physical performance of the instrument was important and that data telemetry and logging would benefit from developing technology.

The consensus resulting from workshop discussions is expected to provide a strong foundation for the development of new tools to aid firefighters in selecting the appropriate respiratory protection, standard testing protocols to insure that equipment meets the needs of first responders, and performance criteria that allow industry to adapt the technology to the specific need and improve where necessary.

**Review:**

- Focuses on particulates and dust.
- They range in size from 0.002  $\mu\text{m}$  to 100  $\mu\text{m}$
- The American Conference of Governmental Industrial Hygienists (ACGIH) “believes that even biologically inert, insoluble, or poorly soluble particles may have adverse effects and recommends that airborne concentrations should be kept below 3  $\text{mg}/\text{m}^3$  for respirable particles, and 10  $\text{mg}/\text{m}^3$ , for inhalable particles....” [6] Respirable particles are defined as particulate material that is hazardous when deposited in the alveoli region of the lungs, while inhalable particles refer to particulate matter that is hazardous when deposited anywhere within the respiratory tract. [6] The U.S. Department of Labor Occupational Safety and Health Administration (OSHA) suggest that 8-hour time-weighted average (TWA) exposures be kept below 5  $\text{mg}/\text{m}^3$  for respirable dust and 15  $\text{mg}/\text{m}^3$  for total suspended (inhalable) dust.
- The health effect of particulate exposure is a function of the size, shape, and chemical composition. A particle’s size is often given in terms of its aerodynamic diameter, defined as the diameter of a sphere with 1  $\text{g}/\text{cm}^3$  density that has the same settling velocity of the particle of interest. Particles up to 100  $\mu\text{m}$  can be inhaled into the respiratory system, although only particles less than 10  $\mu\text{m}$  penetrate into the pulmonary region of the lung. Fine particles smaller than 4.0  $\mu\text{m}$  may enter the alveoli, where only a thin layer of cells separate the respired air from blood in the circulatory system. These small particles that deposit into the alveoli may transfer out of the lungs and into the blood, where they are transported to and may affect other organs. Within the lung itself, high concentrations of deposited particles may exceed the natural ability of the lung to clear particles; when this happens, particles may become imbedded in the lung tissue itself and cause chronic pulmonary inflammation and cancer. Fibrous particles that are long and thin may also penetrate deeply into the lungs. Finally, the chemical composition of the particle and any gases that adsorb onto the particle may transport irritants or carcinogens to the lung tissue.
- Toxic components of particulates can include: Asbestos, lead, other metals, PCBs, PAHs, VOCs and alkalinity.
- Comments on the extreme case of the world trade center collapse.
- Summary table of particulate measurements from other studies in APPENDIX A-6: TABLES FROM [BRYANT 2007].
- Descriptions of the types of particle monitors and measurement devices.

- The research needs determined by the workshop were: Health Effects for Firefighters from Overhaul, Particulate Characterization in Overhaul, Detector Response in Overhaul, Demonstration of Benefits, Hazard of Overhaul, New Filter Cartridge

**7. Burgess JL, Nanson CJ, Bolstad-Johnson DM *et al.* (2001) Adverse respiratory effects following overhaul in firefighters. *J Occup Environ Med*; 43: 467-73.**

**Abstract:** Overhaul is the stage in which firefighters search for and extinguish possible sources of reignition. It is common practice not to wear respiratory protection during overhaul. Fifty-one firefighters in two groups, 25 without respiratory protection and 26 wearing cartridge respirators, were monitored for exposure to products of combustion and changes in spirometric measurements and lung permeability following overhaul of a structural fire. Testing at baseline and 1 hour after overhaul included forced vital capacity (FVC), forced expiratory volume in one second (FEV1), serum Clara cell protein (CC16), and serum surfactant-associated protein A (SP-A). Overhaul increased CC16 in both groups, indicating increased alveolarcapillary membrane permeability. Contrary to expectations, SP-A increased and FVC and FEV1 decreased in the firefighters wearing cartridge respirators. Changes in FEV1, CC16, and SP-A were associated with concentrations of specific products of combustion or carboxyhemoglobin levels. Firefighter exposures during overhaul have the potential to cause changes in spirometric measurements and lung permeability, and self-contained breathing apparatus should be worn during overhaul to prevent lung injury.

**Review:**

- Positive-pressure SCBA provide protection factors often exceeding 10,000, indicating a 10,000-fold reduction in concentration of contaminants inside the respirator facepiece as compared with the ambient environment.
- A limitation of most firefighter studies has been that the only measurement of lung injury used was spirometry, and other adverse pulmonary effects, such as decline in diffusing capacity, can occur without changes in spirometric measurements.
- However, concentrations of certain products of combustion can still be elevated during overhaul.<sup>5,23</sup> These products include acrolein, benzene, carbon monoxide, formaldehyde, glutaraldehyde, nitrogen dioxide, particulates, and sulfur dioxide. Given that the overhaul phase is generally short (.30 minutes for most fires), the health effects of exposure to these chemical concentrations are not known. The purpose of this research was to measure the adverse effects of exposure to products of combustion during overhaul using both spirometry and serum pneumoproteins, and to determine whether the use of cartridge respirators could decrease any adverse health effects associated with this exposure.
- A total of 105 firefighters (53 in Tucson and 52 in Phoenix) participated in baseline testing, of whom 51 (25 in Tucson and 26 in Phoenix) participated in overhaul testing.
- The Tucson firefighters removed their SCBA during overhaul and the Phoenix firefighters used a cartridge on their facepiece (A T-piece adaptor was used to place multipurpose cartridges (Scott Aviation Model 642-MPC-P100, Monroe, NC) on the facepiece.
- These cartridges protect against particulate, organic vapor, ammonia, methylamine, sulfur dioxide, formaldehyde, chlorine, chlorine dioxide, hydrogen chloride, and hydrogen

fluoride exposure. Phoenix firefighters generally monitored carbon monoxide concentrations and did not begin overhaul until levels were below 150 parts per million (ppm).

- Blood was drawn from the participants and was tested before and after exposure. Pulmonary function testing was also done.
- Overhaul activities were conducted for a minimum of 25 minutes.
- Other measurements included National Dräger (Pittsburgh, PA) Miniwarn four-gas direct-read meters (configured to detect carbon monoxide, nitrogen dioxide, sulfur dioxide, and methane) and Pac III single-gas meters (configured for hydrogen cyanide) were used to collect continuous exposure data. Sorbent tube samples were collected for aldehydes (acetaldehyde, acrolein, benzaldehyde, formaldehyde, glutaraldehyde, isovaleraldehyde), benzene, hydrogen chloride, and sulfuric acid. Hydrogen cyanide was measured with sorbent tubes in Phoenix only. In Tucson, lead, cadmium, and chromium were measured in a personal total dust sample. Respirable dust was sampled using personal cyclone samplers (Mine Safety Appliance, Pittsburgh, PA) equipped with preweighted polyvinyl chloride filters
- Measurements were made in 7 actual fires and 2 training fires in Phoenix and 5 actual fire and 2 training fires in Tucson.
- See tabular results in APPENDIX A-7: TABLES FROM [BURGESS 2001]
- Our study observed acute changes in spirometric measurements and lung permeability following firefighter overhaul; these changes were not prevented by the use of full-face cartridge respirators.
- Finally, the long-term consequences of these findings are not known. We expect that the changes observed in this study are transient. We intend to evaluate annual follow-up data on the firefighters in this study to confirm this expectation. However, repeat acute exposures could have persistent adverse health effects, and given that wood combustion products contain substances capable of damaging DNA,<sup>38</sup> cancer from occupational exposure is also a concern. The present practice of performing overhaul without respiratory protection should be reevaluated in light of the findings of this study. The use of serum pneumoproteins provided additional information on lung permeability to complement the use of spirometry and helped to determine the extent of lung injury associated with fire overhaul.
- Because cartridge respirators do not seem to provide complete protection against changes in spirometric measurements and serum pneumoproteins, either increasing the time interval between extinguishment and overhaul or continuing the use of SCBA for overhaul is recommended.

**8. Burgess WA, Lynch JJ, Buchanan P *et al.* (1977) Minimum protection factors for respiratory protective devices for firefighters. *Am Ind Hyg Assoc J*; 38: 18-23.**

**Abstract:** Carbon monoxide and oxygen concentrations were measured in seventy-two structural fires using a personal air sampler carried by working firefighters. In a total sampling time of 1329 minutes the carbon monoxide concentration exceeded 500 ppm approximately 29 percent of the time. The maximum carbon monoxide concentration was 27,000 ppm and in 10 percent of the fires, the maximum concentration exceeded 5500 ppm. Only six runs indicated oxygen concentrations less than 18 percent. On the basis of these

exposure data, a minimum protection factor of 100 is proposed for breathing apparatus for structural firefighting.

**Review:**

- In Aug 1972, samplers were placed with 2 Boston Fd engine companies and 1 month later placed with 2 more engine companies.
- Field measurements lasted 10 months and data was recorded at 72 fires.
- Average sampling time was 18.5 min.
- Of the 1329 min of total sampling CO exceeded 0.05%, 29% of the time.
- Highest CO value recorded was 2.7%
- Only 6 incidents had oxygen concentration less than 18% and the lowest was 15.5%
- Measurements are thought to represent worse case scenarios and not routine exposures.
- The mean exposure of Co without a respirator was .4%
- The sampling program suggests it is impossible for the firefighters to anticipate the conditions under which breathing apparatus must be used. Until a suitable instrument is available to monitor the exposure, breathing apparatus should be used continuously in structural fires.
- See APPENDIX A-8: TABLES AND FIGURES FROM [BURGESS 1977] for tabular results.

**9. Gold A, Burgess WA, Clougherty EV. (1978) Exposure of firefighters to toxic air contaminants. Am Ind Hyg Assoc J; 39: 534--539.**

**Abstract:** A personal sampling apparatus for firefighters was developed to sample the fire atmosphere for CO, CO<sub>2</sub>, O<sub>2</sub>, N<sub>2</sub>, HCl, HCN and particulate content. Two fire companies made ninety successful sample runs during structural fires. CO presented a potential acute hazard and particulate concentrations were high. HCN was detected at low levels in half the samples. Hel was detected in only eight samples but on two occasions exceeded 100 ppm. CO<sub>2</sub> and N<sub>2</sub> levels and O<sub>2</sub> depression do not appear to represent significant hazards.

**Review:**

- Studied two units of the Boston Fire Department and identified four atmospheric components that represented serious health hazards: carbon monoxide, hydrogen cyanide, hydrogen chloride, and particulates.
- See APPENDIX A-9: TABLES AND FIGURES FROM [GOLD 1978] for picture of sampling device and results table.
- 2 companies each made 45 sample runs. They were asked to activate in the area of the fire and shut down upon leaving the area.
- *Nitrogen dioxide.* The analysis is based on a modified Saltzmann method(12,13) in which the N<sub>2</sub> is trapped on 13X molecular sieves impregnated with triethanolamine (TEA).
- *Carbon monoxide, oxygen and carbon dioxide.* These three gases are determined in the bag ~ sample at the fire station. CO is determined with an Ecolyzer Model 2400, O<sub>2</sub> is determined by a Beckman Model D paramagnetic oxygen analyzer and CO<sub>2</sub> by Bendix 2L CO<sub>2</sub> detector tubes.

- *Particulates.* Particulates are collected on pretared 25 mm binderless glass fiber filters and determined gravimetrically. The filter cassette is attached to the Ascarite reagent tube.
- The median value for CO was 110 ppm. The median concentration of particulates was 22 mg/m<sup>3</sup>. 6 incidents had HCN over 1ppm. The highest value of HCl was 150 ppm.
- The data indicate that carbon monoxide is the one gas of those monitored that could involve a potential acute hazard for the firefighters of Aerial Tower 2 and Engine 43. Particulates may occur in high enough concentrations to have significant long term health effects. Although hydrogen cyanide was frequently detected, concentrations did not pose an acute hazard based on the Short Term Exposure Limit of 15 ppm.

**10. Hester SA. (2006) The “Other” Occupational Hazard. National Fire and Rescue; November/December: 18.**

**Review:**

- 1 page magazine article from a fire chief in Montana.
- Poses the question of what is coming off of the gear and equipment after a fire. If you can smell it days later is it hazardous, also “Could that telltale smell shorten my lifespan?”
- He looks at research that has been done which while not conclusive seems to identify that many products produced by fire are bad for firefighters.
- He suggests that, the fireground gets treated like a HazMat incident, designate fire house clean areas, enforce strict personnel decontamination and hygiene procedures and properly decontaminate all fire ground tools, equipment and apparatus.

**11. Jankovic J, Jones W, Burkhard J et al. (1991) Environmental study of firefighters. Ann Occup Hyg; 35: 581-602.**

**Abstract:** A study of firefighter exposures was undertaken at the request of the U.S Fire Administration. This work was part of a larger study which included field evaluation of the performance of the self-contained breathing apparatus (SCBA) worn by firefighters during structural firefighting. Measurements were made for a variety of contaminants including CO, CO<sub>2</sub>, benzene, HCN, HCl, H<sub>2</sub>SO<sub>4</sub>, HF, acrolein, CH<sub>4</sub>, formaldehyde and PNAs. Many of the analyses were performed by collection of bag samples followed by Fourier transform infrared spectroscopy using a field mobile spectrometer. Measurements were also made using solid sorbent tubes and direct reading meters. Sampling was done both during the knockdown and during overhaul phases of structural firefighting. Also, in order to estimate exposures including those when the SCBAs were worn, measurements were made both inside and outside the SCBA facepiece.

Carbon monoxide was the most common contaminant found during knockdown, and about 10% of the samples were greater than 1500 ppm. Formaldehyde, acrolein, hydrogen chloride, hydrogen cyanide, sulfuric acid and hydrogen fluoride all exceeded their respective short-term exposure limits (STEL) on some occasions. Approximately 50% of the knockdown samples for acrolein exceeded the STEL. During overhaul, when masks were usually not worn, many of the contaminants found during knockdown were detected, but typically at much lower concentrations. Inside-mask sampling data suggest that exposure to low



concentrations of a variety of compounds is occurring but this is believed to be principally the result of early mask removal or of non-use during knockdown rather than of leakage. The three basic sampling approaches (bag sampling, sorbent tubes and direct-reading meters) proved in this study to be complementary and served to maximize our ability to detect and quantify a wide range of combustion products.

**Review:**

- For measurements both inside and outside the firefighters mask, it was decided to limit sampling to gases collected in an airbag and analysed using Fourier transform infrared spectroscopy (FTIR). This technique was chosen because of the compactness of the sampling system, the variety of gases which absorb in the i.r. region and the availability of a system which could operate from a mobile laboratory, thus making possible rapid analysis of the samples. Recognizing that even with quick analysis reactive gases might be lost, and that components in other phases would not be detectable with the FTIR system, we also used a variety of solid sorbent tubes, filters, impactors and direct-reading meters.
- Interferograms for each gas sample were produced as rapidly as possible, usually within 30 min of collection, using a Nicolet 20 SXC FTIR spectrometer equipped with a liquid-nitrogen-cooled mercury-cadmium—telluride (MCT) sandwich detector (Nicolet Instrument Corp.)
- A total of 32 interferograms were collected and averaged for each sample at a spectral resolution of 0.5 cm<sup>-1</sup>. All sample spectra were collected at a total pressure of 740 Torr. Sample spectra were ratioed against a background of high purity nitrogen. Gas concentrations for a variety of pre-determined compounds were calculated by computer, using a least-squares fit (LSF) algorithm modified by the manufacturer for our application (HAALAND and EASTERLING, 1982)
- During the course of this study we were able to collect and analyse samples from a total of 22 fires: six training fires, 15 residential fires and one automobile fire.
- See APPENDIX A-10: TABLES AND FIGURES FROM [JANKOVIC 1991] for pictures and tabular results.
- Examining the results from the i.r. analysis of air bag samples with the GC-MS assay from charcoal tube samples it is evident that many of the compounds observed by GC-MS, which are known to absorb in the i.r. region, do not appear in the i.r. analysis. This demonstrates the increased sensitivity gained by concentrating the sample on a solid sorbent allowing for the determination of compounds present in too low a concentration to be observed unconcentrated in a bag sample. On the other hand, solid sorbents vary in their efficiency in capturing different classes of compounds, while the collection efficiency for bag sampling is essentially 100% for all gases. Thus we were able to detect low-boiling-point hydrocarbons in the i.r. spectra while these compounds were not detected on the GC-MS spectra owing to inefficient collection on charcoal tubes. The two approaches are, therefore, complementary and when used together can maximize the ability to detect combustion products.
- Carbon monoxide was the most persistent contaminant with about 10% of values greater than 1500 ppm.

- Levels of acrolein, formaldehyde, HCL, HCN and sulphuric acid were all on occasion greater than their respective short-term exposure limits. About 50% of the acrolein samples exceeded the STEL. Environmental study of firefighters 601
- For those contaminants which had been previously measured in past studies of firefighters there was generally good agreement with our results.
- *Overhaul measurements* — Many of the same contaminants found in knockdown were also detected during overhaul activities.
- Concentrations were low relative to ambient knockdown values and generally of the order of concentrations measured inside the masks during knockdown. The exception was fibre counts which were higher in overhaul than in knockdown.

**12. Jankovic H, Jones W, Castarnova Vet ai. (1993) Measurement of short-lived reactive species and long-lived free radicals in air samples from structural fires. Appl Occup Environ Hyg; 8: 650-4.**

**Abstract:** This article constitutes part of a comprehensive firefighter exposure study undertaken by the National Institute for Occupational Safety and Health at the request of the u.s. Fire Administration. An earlier study reported the detection of a wide variety of contaminants during knockdown and overhaul phases of structural fires (Jankovic *et al.*: Ann. Occup. Hyg. 35:581; 1991). This article describes a chemiluminescence (CL)-based field methodology for detecting short-lived reactive intermediates in the fire atmosphere. The results demonstrate the presence of short-lived, hence reactive, chemical species even when no smoke was visible. Additionally, electron spin resonance (ESR) spectroscopic measurements on filter samples collected from the same fires demonstrate the presence of long-lived (half-life of several days) organic- free radicals whose concentration correlates with the amount of smoke in the atmosphere. The presence of CL-detected short-lived reactive intermediates and ESR detected long-lived radicals provides a plausible mechanism to explain the known phenomena of "incapacitation without cause" as well as chronic lung injury related to smoke inhalation.

**Review:**

- This paper is an expansion of the previous paper.
- Combustion involves a series of oxidation-reduction reactions which generate reactive species and free radicals. Two laboratory techniques were utilized to monitor reactive compounds associated with fire smoke. These techniques were chemiluminescence (CL) and electron spin resonance (ESR) spectroscopy.
- Laboratory trials indicate that reactive species from fire smoke can be monitored by luminol-enhanced CL.
- CL was highest immediately after sampling and rapidly declined with time as would be expected for reactions involving short-lived reactive species. However, CL from the smoke samples remained elevated above controls for as long as 22 hours after sampling. The half time for decay to the 22 hour level was 4 minutes for filter samples and 5 minutes for impinger samples. In genera~ CL from impinger samples was approximately three times greater than that obtained from filter samples.
- Both short- and long-lived radicals were found during the overhaul phase of fire fighting. The presence of these radicals, at a time when fire fighters are not wearing respiratory

protection, may have chronic toxicological implications. Short-lived radicals appear to be detected by the CL technique employed in the study and do not appear to be directly related to visible smoke. The short-lived radicals, because they are highly reactive, may have limited potential for pulmonary penetration. Further study will be necessary to elucidate the potential for free radical penetration in the respiratory system in the absence of visible smoke. On the other hand, high concentrations of longer-lived free radicals seemed to be entrapped in smoke particles and were measured on filter samples by ESR spectrometry. The magnitude of the ESR signal was related to the intensity of the smoke. Association of these radicals with respirable particles would allow them to penetrate deeply into the lungs where lung injury may occur.

**13. Kinnes GM and Hine GA, (1998) Health Hazard Evaluation Report 96-0171-2692 Bureau of Alcohol, Tobacco, and Firearms Washington, D.C., HETA-96-0171-2692 NIOSH, Cincinnati, Ohio.**

**Summary:** In April 1996, the National Institute for Occupational Safety and Health (NIOSH) received a request for a health hazard evaluation (HHE) from the Bureau of Alcohol, Tobacco, and Firearms (ATF), in Falls Church, Virginia, regarding respiratory hazards associated with fire investigations. ATF trains a select number of special agents as fire investigators as part of the ATF arson enforcement program. These special agents work with counterparts in state and local fire departments to investigate the origin and cause of fires. ATF special agents and local fire investigators in the northern Virginia jurisdictions were concerned about the potential respiratory health effects from conducting fire scene examinations and the adequacy of their respiratory protection.

In response to this request, environmental monitoring was performed during the investigation of two house fires on February 12 and 13, 1997, in metropolitan Washington, D.C., and Prince George's County, Maryland, and three staged fires on June 3, 1997, at the Fort Belvoir military base in Alexandria, Virginia. During these fire scene examinations, environmental samples were collected for total and respirable dust, metals, hydrogen cyanide, inorganic acids, aldehydes including formaldehyde, polycyclic aromatic hydrocarbons (PAHs), elemental carbon, and volatile organic compounds (VOCs).

The environmental monitoring indicated that low or trace concentrations, between the minimum detectable concentration (MDC) and minimum quantifiable concentration (MQC), were found for most of the analytes. However, formaldehyde was detected at concentrations up to 0.18 parts per million (ppm). Two formaldehyde samples collected during the staged fire scenes exceeded the NIOSH recommended exposure limit of 0.1 ppm (ceiling). Low or trace concentrations of acetaldehyde, acrolein, and furfural were also detected. NIOSH considers both formaldehyde and acetaldehyde to be potential occupational carcinogens and recommends that exposures be controlled to the lowest feasible concentration. Area air concentrations of hydrogen cyanide ranged from not detected to 0.04 ppm, while the concentrations for personal breathing zone (PBZ) samples ranged from a trace concentration to 0.03 ppm. Sulfuric acid was the only inorganic acid that had a concentration above the MQC, ranging from trace concentrations to 0.29 milligrams per cubic meter (mg/m<sup>3</sup>) of air. The major VOCs identified during these fire scenes were aliphatic hydrocarbons in the C<sub>9</sub>

and higher molecular weight range, acetone, acetic acid, ethyl acetate, isopropanol, styrene, benzene, toluene, xylene, styrene, furfural, phenol, and naphthalene. Several PAHs were also detected, and three of these are considered to have carcinogenic potential in humans. These included benz(*a*)anthracene with concentrations ranging from 0.09–0.29 micrograms per cubic meter (:g/m<sup>3</sup>) of air, benzo(*b*)fluoranthene with concentrations ranging from trace–0.21 :g/m<sup>3</sup>, and benzo(*a*)pyrene with concentrations ranging from 0.11–0.39 :g/m<sup>3</sup>. With the exception of the formaldehyde concentrations, all of these concentrations were well below the relevant evaluation criteria.

Total and respirable dust were also detected at time-weighted average (TWA) concentrations up to 5.3 and 1.3 mg/m<sup>3</sup>, respectively. These concentrations were below their relevant evaluation criteria. However, peak total dust concentrations up to 30 mg/m<sup>3</sup> were measured with a real-time portable dust monitor (Grimm); this indicated that excessive total and respirable dust concentrations were encountered for short durations during some activities. The mass median aerodynamic dust diameters extended from 6.1 micrometers (Fg = 3.1) to 12 micrometers (Fg = 2.5). These results indicated that dust generated during these activities can be respirable and inhalable.

Formaldehyde concentrations exceeding the NIOSH ceiling limit of 0.1 ppm and exposures to several PAHs (which are suspected of having carcinogenic potential in humans) were measured. This indicates that fire investigator exposures to irritants which cause acute effects and carcinogens which have chronic effects are of concern. Total and respirable dust levels were detected at TWA concentrations up to 5.3 and 1.3 mg/m<sup>3</sup>, respectively, and peak concentrations up to 30 mg/m<sup>3</sup> (total dust). A significant percentage of this measured mass was due to particle sizes in the respirable and inhalable range. Both the environmental sampling results and observations made during the five fire scene investigations indicated that the use of appropriate respiratory protection and mechanical ventilation equipment can reduce the potential for exposure. Several fire investigators, who did not wear respiratory protection, experienced both eye and respiratory irritation during these investigations.

**Review:**

- Focuses on fire investigation which would be after overhaul and sometimes significantly after overhaul.
- 3 staged fires and 2 actual fire scenes were measured and documented.
- Except for the samples obtained with the direct-reading instrument (Grimm), air samples were *Health Hazard Evaluation Report No. 96-0171 Page 7* collected using calibrated battery-operated sampling pumps with the appropriate sorbent tube or filter media connected via Tygon® tubing. The area and personal breathing zone sample concentrations were calculated based on the actual monitoring time (time-weighted average [TWA-actual] concentrations) instead of calculating an 8-hour TWA concentration, so that the sampling data could be compared between the different scenes with unequal monitoring durations. Calibration of the air sampling pumps with the appropriate sampling media was performed daily, before and after each monitoring period. Field blanks were submitted to the laboratory for each analytical method.

- The environmental monitoring indicated that contaminant concentrations were generally greater during the staged fire scene investigations than the actual fire scene investigations.
- Although the environmental sampling conducted during this investigation indicated that most contaminant concentrations did not exceed the relevant evaluation criteria, it still indicated that the potential for exposure exists. In addition, the sampling indicated that the potential for exposure to carcinogens existed to some extent. Exposures to formaldehyde concentrations which exceeded the NIOSH ceiling limit of 0.1 ppm and to several PAHs (which are suspected of having carcinogenic potential in humans) were observed. This indicates that both acute and chronic exposures to fire investigators are of concern. Total and respirable dust were also detected at TWA concentrations up to 5.3 and 1.3 mg/m<sup>3</sup>, respectively. The Grimm *Page 12 Health Hazard Evaluation Report No. 96-0171* portable dust analyzer indicated that peak concentrations of total dust up to 30 mg/m<sup>3</sup> were possible and that a significant percentage of this measured mass was due to particle sizes in the respirable and inhalable range. Observations made during the five fire scene investigations indicated that the use of appropriate respiratory protection and mechanical ventilation equipment can significantly reduce the potential for exposure. Several fire investigators, who did not wear respiratory protection, experienced both eye and respiratory irritation during these investigations.
- See APPENDIX A-11: TABLES FROM [KINES 1996] for data.

**14. Lowry, W. T., Juarez, L., Petty, C. S., and Roberts, B. (1985) Studies of toxic gas production during actual structural fires in the Dallas area. *J. Forens. Sci.* 30:59-71.**

**Abstract:** Gases produced during structural fires were studied as to their potential toxicities. Carbon monoxide was the only gas measured in concentrations considered to be lethal within a short period of time. No correlations were found between gases produced and materials burning. However, significant correlations were discovered between gases produced and the physical aspects of the fire (intensity, burning rate, and the like). The organic compounds identified within the gases gave insight as to another potential health hazard not yet considered. These organic compounds are the products of free radical reactions and as free radicals their potential as toxics is enormous.

**Review:**

- 72 residential fires were monitored using portable monitoring devices on firefighters.
- The maximum CO reading during the study was 27000ppm.
- In only 6 fires the oxygen concentration dropped below 18%.
- The areas the samples were to be taken was where there was light to dense smoke with little heat.
- Gas samples were analyzed with a Miran IA general IR gas analyzer
- The firefighters wore Model TD Monitaire samplers with a pump calibrated to 0.7 Lpm from MSA
- One pumps pulled samples through calorimetric tubes for CO, HCl, HCN, formaldehyde. The second pump was rigged with a charcoal sampling tube holder.
- Gas was also collected with a Teflon gas collecting tube, a disposable syringe and a paint can.

- A GS/MS was used on the samples.
- The averages measured were CO – 1450, HCl – 1.1ppm, Hydrocyanic Acid – 3.7ppm, Aldehydes 0.5 ppm, Total hydrocarbons – 800 ppm.
- CO exceeded the 400ppm STEL 28.5% of the fires and the 1500ppm IDLH in 10.5%
- Hydrogen Cyanide was detected in 12% of the fires. The maximum measured was 40 ppm. The STEL of 15ppm was found in 10.5% of the fires
- HCl was detected in 9% of the fires with a max of 40ppm seen and only 2.6% exceeded the 5ppm STEL.
- Aldehydes were found in every fire but the STEL was only exceeded in 2.5% of the fires.
- There were no significant patterns of organics seen.

**15. Schnepf, R, ed. (2006) Smoke Perceptions, Myths and Misunderstandings. Cyanide Poisoning Treatment Coalition; 21p.**

**Introduction:** Americans are, by and large, assaulted with a steady stream of so-called “revolutions.” There’s been no shortage of fitness and dietary revolutions over the years, each one offering unbelievable results with a money back guarantee. The ongoing technology revolution has promised increased productivity and more free time, while the computerized banking industry has almost rendered cash obsolete. And while each of these examples has had an impact on daily life, they appear to be more evolutionary than revolutionary. It’s gotten to the point where “revolution” has become synonymous with benign terms like change, development, or progress. Unfortunately, such common usage of the term has watered down its meaning.

In reality, true revolutions are anything but benign. Revolutions are fueled by a new way of thinking, risk taking, and the courage to do things completely differently. Something the American fire service is not entirely comfortable with. This is not to say that the fire service is backward or unable to embrace new ideas. It is however, accurately characterized as 200 years of tradition unimpeded by progress.

Why all the talk of revolution? Because the fire service is on the eve of one. A far-reaching and possibly tumultuous revolution that will challenge everything we thought we knew about smoke - the constant companion of the firefighter.

Research conducted over the years has proven that smoke is bad - we all know that. We all know that smoke kills more people than flames and that breathing smoke isn’t good. So why do we still go to fires and not wear our SCBA? And I’m not talking about wearing the tank with the mask dangling around your neck. After the fire is knocked down, why is it that firefighters drop their SCBA and perform overhaul in the smoldering debris, breathing all those products of incomplete combustions? Why do we put so much effort into rapid intervention teams, when the current method of medically treating someone after the rescue is largely ineffective? We’ve figured out a better way to rescue our own, but have not completed the loop by providing an effective antidote to correct a potential cause of death in smoke inhalation victims - cyanide poisoning. Typically, when someone dies in a fire, it’s attributed to the nebulous cause of “smoke inhalation.” In truth, it’s more complicated than that - we just haven’t been looking at it the right way. We haven’t really digested the

combustion chemistry to truly understand why the smoke is so nasty. Understanding the basics of combustion chemistry is the first step toward gaining a new respect for an old foe.

It's fitting that this smoke revolution finds its roots in a busy fire department like Providence, Rhode Island - a key player in the American Revolution. In this supplement, Chief of Department David Costa provides a detailed description of a series of fire incidents that are emerging as a shot heard 'round the world for the fire service. He describes an investigation that reached an unexpected conclusion: a large number of his firefighters were exposed to cyanide - from the smoke - after fighting a series of structure fires. These firefighters were operating at the same kind of fires occurring every day in each and every part of this country - the typical residential structure fire.

I encourage you to read about Chief Costa's journey. A journey that every Fire Chief hopes to avoid - one that ends with a visit to a firefighter's spouse, telling them that their loved one has been injured on the job.

I hope you'll take the time to read the articles following Chief Costa's foreword. You'll learn about combustion chemistry, better ways to manage your air while fighting fire, the signs and symptoms of smoke inhalation, and why current methods of treating smoke inhalation victims may be futile. The last piece, written by Dr. Jean-Luc Fortin, offers a look inside a successful resuscitation of a firefighter in Paris, France. The firefighter, overcome by smoke after getting lost inside a structure fire, is alive and well today because of aggressive pre-hospital care and an antidote for cyanide poisoning.

The bottom line is this - the fire service needs to become better educated about smoke. Hopefully, an increased level of knowledge will reinforce the importance of respiratory protection on the fireground, and the need to properly manage your air supply. It's better to avoid getting into trouble than relying on a rapid intervention team to come in and find you! Unfortunately, a low air emergency does not come with a "money back" guarantee.

Smoke has become such a constant companion for us that we may have lost respect for it. According to Chief Costa, his department was shocked by the cyanide exposures. "We haven't come up with a firm grasp of what will be different," he says. "It's too early to tell. There is, however, a lot of lively discussion going on around the firehouse coffee table."

And that's what we need to better appreciate the immediate and long terms effects of breathing smoke - a lively discussion. We also need a drastic modification of our attitude toward smoke. Most of all, it's important to keep an open mind about the research and data presented here. You might discover some solutions on the following pages, but more than anything, I hope it raises some questions.

#### **Review:**

- This is a compilation of 7 articles that focus on cyanide and overhaul is included.
- Use of fiberglass insulation in American building construction is much higher today than 30 years ago. Many fire departments' tactical overhaul and extinguishing operations have not been updated to address these and other changes that make smoke increasingly

dangerous. For their health and safety, firefighters need to understand that today's fire smoke is more dangerous than ever. The days of the "smoke-eater" culture needs to end.

- Mentions the hazards of isocyanates with references to Sweden
- RECOMMENDATIONS TO THE AMERICAN FIRE SERVICE **1.** Increase education of firefighters and civilians about the risk of cyanide poisoning from fire smoke. **2.** Support blood testing for cyanide of firefighters and fire victims. **3.** Support the use of safe cyanide treatment antidotes (hydroxocobalamin) in the United States to treat firefighters and civilian smoke inhalation victims. **4.** Submit to the NFPA scientific research to identify health and safety issues related to mandatory air management standards especially during overhaul operations.
- An overhaul policy must have a few important pieces to make it work. • First, there should be an air support unit on scene. Fire crews will be breathing through many SCBA cylinders during overhaul, so the air unit must be there to refill or replace empty cylinders in a timely fashion. • Next, firefighters should follow the ROAM (see the preceding article entitled "Air Management on the Fireground: The Need - The Mandate - The Solution" for more details on the ROAM) concept during fire overhaul. • Finally, firefighters should ensure they are out of the hazardous environment before their low-air warning alarm activates. Again, this gives firefighters a safety margin should they become trapped or lost in the structure.
- Fire overhaul is necessary to assure that the fire is out and will not rekindle. However, the post-fire environment is dangerous due to irritants, toxic gases, and carcinogens in the atmosphere. Firefighters must wear their SCBA during this overhaul phase of firefighting to protect them from breathing in these harmful compounds. Fire departments must adopt a comprehensive respiratory protection program that mandates the wearing and use of SCBA during all phases of the fire and adheres to safe and effective air management practices.

**16. Treitman RD, Burgess WA, Gold A. (1980) Air contaminants encountered by firefighters. Am Ind Hyg Assoc J; 41: 796-802.**

**Abstract:** The concentrations of eight air contaminants suspected of causing acute and chronic health problems for firefighters were measured in over 200 fires in the City of Boston using a personal air sampler. Threatening concentrations of both carbon monoxide and acrolein were found in a small proportion of the fires. Less hazardous levels of hydrogen chloride, hydrogen cyanide, nitrogen dioxide and carbon dioxide were also noted. Benzene was found in most fires, but at concentrations well below those expected to cause acute injury. The air sampling data have application in treatment of smoke inhalation victims, development of firefighting strategies and selection of respiratory protection devices.

**Review:**

- In consultation with the Boston firefighters, we developed the chest-mounted air sampling unit shown in Figure 1. A solid-state commutated DC motor, powered by a rechargeable nickel-cadmium battery, drives two diaphragm air sampling pumps. One pump element services a sampling train consisting of a glass fiber filter, a charcoal tube, and a Tedlar collection bag. After passing through the filter which removes the particulates, the air sample passes through the activated charcoal tube for collection of



aromatic hydrocarbons and other gases and vapors. The pump discharge is then split; a portion is directed to the Tedlar bag while the balance is exhausted inside the sample case. The 1 L Tedlar bag sample is used for analysis of carbon monoxide and carbon dioxide. This procedure permits collection of a 1L bag sample while passing several liters of air through the filter and charcoal, thus improving the detection limit for ~ the air contaminants collected on these elements. The second air sample flows into an inlet manifold which holds tubes containing Ascarite for the collection of hydrogen cyanide, activated molecular sieve for the collection of acrolein, and triethanolamine-treated molecular sieve for the collection of hydrogen chloride and nitrogen dioxide. A stroke counter and "on" light are also powered by the battery.

- Benzene was collected on activated charcoal, desorbed with carbon disulfide, and analyzed by gas chromatography. The detection limit is 3 ppm in a 1L sample.
- See APPENDIX A-12: TABLES AND FIGURES FROM [TREITMAN 1980] for tables with measurement methods and results
- NO<sub>2</sub> alone does not pose an acute hazard
- HCl could be found in doses to cause irritation but no acute hazards
- HCN did not approach significant levels and was not detected in 90% of the fires.
- Acrolein had 50% of the fires were above the STEL and 10% were in excess of 3ppm, close to IDLH
- Particulates were in high enough concentrations to cause severe irritation.
- CO exceeded the 400ppm STEL 16 times and the 1500ppm 4 times
- CO<sub>2</sub> exceeded the 15000 ppm STEL 3 times and the 50000 IDLH once.
- Benzene was detected in 181 of 197 samples analyzed.
- The personal monitoring of firefighter exposures to toxic air contaminants during structural fires in Boston has confirmed the complexity of the exposures. Carbon monoxide and acrolein were the most hazardous specific air contaminants in this series of fires, while combinations of respiratory irritants (e.g., acrolein, hydrogen chloride, and nitrogen dioxide) acting in a synergistic manner may be important in selected fires. The combined effects of mixtures of these and other irritants, especially in the presence of high particulate concentrations, often make effective work by the firefighter impossible without respiratory protection. The concentrations of hydrogen cyanide and carbon dioxide were not found to be significant health hazards. This study confirms earlier work by this laboratory which indicates that firefighters should wear respirators at all structural fires.

**17. Leonard SS, Castranova V, Chen BT, et al. (2007) Particle size-dependent radical generation from wildland fire smoke. Toxicology 236, 103-113.**

Abstract: Firefighting, along with construction, mining and agriculture, ranks among the most dangerous occupations. In addition, the work environment of firefighters is unlike that of any other occupation, not only because of the obvious physical hazards but also due to the respiratory and systemic health hazards of smoke inhalation resulting from combustion. A significant amount of research has been devoted to studying municipal firefighters; however, these studies may not be useful in wildland firefighter exposures, because the two work environments are so different. Not only are wildland firefighters exposed to different combustion products, but their exposure profiles are different. The combustion products

wildland firefighters are exposed to can vary greatly in characteristics due to the type and amount of material being burned, soil conditions, temperature and exposure time. Smoke inhalation is one of the greatest concerns for firefighter health and it has been shown that the smoke consists of a large number of particles. These smoke particles contain intermediates of hydrogen, carbon and oxygen free radicals, which may pose a potential health risk. Our investigation looked into the involvement of free radicals in smoke toxicity and the relationship between particle size and radical generation. Samples were collected in discrete aerodynamic particle sizes from a wildfire in Alaska, preserved and then shipped to our laboratory for analysis. Electron spin resonance was used to measure carbon-centered as well as hydroxyl radicals produced by a Fenton-like reaction with wildfire smoke. Further study of reactive oxygen species was conducted using analysis of cellular H<sub>2</sub>O<sub>2</sub> generation, lipid peroxidation of cellular membranes and DNA damage. Results demonstrate that coarse size-range particles contained more carbon radicals per unit mass than the ultrafine particles; however, the ultrafine particles generated more OH radicals in the acellular Fenton-like reaction. The ultrafine particles also caused significant increases in H<sub>2</sub>O<sub>2</sub> production by monocytes and lipid peroxidation. All particle sizes showed the ability to cause DNA damage. These results indicate that the radical generation and the damage caused by them is not only a function of surface area but is also influenced by changing chemical and other characteristics due to particle size.

**Review:**

- In many parts of the country municipal firefighters also respond to wildland or large brush fires and see these exposures. While different they can be compounding.
- Previous studies of wildland firefighters showed cross-season changes in prevalence of one or more respiratory symptom(s) (Rothman et al., 1991; Liu et al., 1992; Betchley et al., 1997). Respiratory problems are estimated to affect 5–10% of wildland firefighters. Studies of forest firefighters have shown both short and long-term effects on their pulmonary functions (Rothman et al., 1991; Serra et al., 1996). Another study (Jalava et al., 2006) found major differences between the coarse and ultrafine particles in proinflammatory cytokines production and apoptosis in RAW 264.7 cells. However, differences in MTT tests and NO production were relatively small. The study suggests that the aerosol smoke particles, which had undergone long-range transport, had chemically transformed during aging.
- We hypothesize that free radicals are associated with wildfire smoke and that particle size plays a role in the type of radicals generated. Furthermore, these radicals are related to hydrogen peroxide generation, and have the ability to cause lipid peroxidation and DNA strand breaks. Our hypothesis will be tested by performing experiments related to the following specific aims: (1) determine and quantify particle-induced ROS associated with particle size using a cell-free model. (2) Define the mechanism and types of radicals involved in the process. (3) Determine if cellular exposure to wildland fire can cause activation of redox systems. (4) Determine if wildland fire smokes samples have the ability to cause DNA strand breaks associated with ROS. The major goals of the present study are focused on answering these questions.
- Six sets of aerodynamically size-selected aerosol samples were collected with the Micro-Orifice Uniform Deposit Impactor (MOUDI) model# 110 with rotator (MSP, Inc.,

Minneapolis, MN, USA) at wildfire mop-up and back-burn operations over the course of 5 days.

- The MOUDI is an 11-stage research-grade cascade impactor (including a final filter to collect particles  $<0.056 \mu\text{m}$ ). Filters used were from Millipore Corp. (Billerica, MA, USA) 47 mm, 0.8 m, PVC model PVC0847600. PVC was selected because it was previously demonstrated to have no effect in the analysis. The MOUDI substrates are normally coated with grease to ensure adherence of deposited particles and to avoid bounce of large particles to lower stages of the impactor. However, grease can alter the surface of collected aerosol particles and is not suitable for use in collecting samples for free radical analysis. Therefore, the cascade impactor was operated without grease substrates to collect and fractionate the smoke aerosol. This approach was based on the assumption that the tarry nature of smoke particles would negate major concerns for particle bounce or entrainment. The MOUDI samplers were placed as close to the fire as was permitted by the hotshot crews in regard to safety of the firefighters and the NIOSH personnel taking the samples. The samplers were supported on a tripod of steel legs in order to place the sampling inlet approximately 5 ft off the ground to simulate breathing space of a firefighter. The average sampling time was 3.5 h. The long sampling time was required in order to obtain sufficient mass within the time period of firefighter exposure. Particle bounce, particularly in the larger sizes, may have been an issue due to the long sampling time. The mass concentration of particulates ranged from 0.75 to 1.3 mg/m<sup>3</sup>. Filters were immediately placed on dry ice and shipped to NIOSH for temporary storage at  $-80 \text{ }^{\circ}\text{C}$  until free radical analysis was performed.
- ESR spin trapping was used to detect both carbon radicals and short-lived free radical intermediates. Carbon radicals were measured directly by placing the filter into a 5mm quartz sample tube and placing it in the ESR cavity. Hydroxyl radicals were measured using the addition-type reaction of a short-lived radical with a paramagnetic compound (spin trap) to form a relatively long-lived free radical product (spin adduct), which can then be studied using conventional ESR. For hydroxyl radical measurements, reactants were mixed in test tubes at a final volume of 1.0 ml of PBS in the presence of 1mM H<sub>2</sub>O<sub>2</sub>. The reaction mixture was then transferred to a flat cell for ESR measurement. Experiments were performed at room temperature and under ambient air.
- Our results determined that wildfire smoke contains both carbon radicals and precursors, which are able to react and generate hydroxyl radicals ( $\bullet\text{OH}$ ) from a Fenton-like reaction with H<sub>2</sub>O<sub>2</sub> as well as ROS generation after exposure to cells. Electron spin resonance (ESR) analysis showed that carbon radicals were found in all filter samples; however, a higher concentration per milligram was found in the coarse (4.2–24  $\mu\text{m}$ ) particles leading us to believe that the larger particles were made up mostly of ash, not fully combusted wood particles, and some soil particles swept up during the process of burning. The decreasing amount of carbon radicals measured in the fine (0.42–2.4  $\mu\text{m}$ ) and the ultrafine (0.042–0.24  $\mu\text{m}$ ) sizes demonstrate that these groups were made up of particles further along in the pyrolysis
- Our results indicated that there were more ROS per milligram in the smaller particles. Specifically, ultrafine particles showed the highest production per unit milligram, which is of interest because these same particles are able to penetrate deep into the pulmonary system and into the alveolar region.

- The results indicate that wildfire smoke is heterogeneous and complex. Particle surface area may be a critical factor in radical production characteristics of wildfire smoke.
- Therefore, our results suggest that wildfire smoke may cause acute lung injury. Since particle size and surface area of the smoke exposure are significant factors in radical generation and particle deposition, particle size should be considered when developing protective strategies.
- See APPENDIX A-13: TABLES FROM [LEONARD 2007] for Table of particle sizes measured.

**18. LeMasters GK, Genaidy AM, Succop P, et al. (2006) Cancer Risk Among Firefighters: A Review and Meta-analysis of 32 Studies. J Occup Environ Med. 2006;48:1189–1202**

**Summary: Objective:** The objective of this study was to review 32 studies on firefighters and to quantitatively and qualitatively determine the cancer risk using a meta-analysis. **Methods:** A comprehensive search of computerized databases and bibliographies from identified articles was performed. Three criteria used to assess the probable, possible, or unlikely risk for 21 cancers included pattern of meta-relative risks, study type, and heterogeneity testing. **Results:** The findings indicated that firefighters had a probable cancer risk for multiple myeloma with a summary risk estimate (SRE) of 1.53 and 95% confidence interval (CI) of 1.21–1.94, non-Hodgkin lymphoma (SRE = 1.51, 95% CI = 1.31–1.73), and prostate (SRE = 1.28; 95% CI = 1.15–1.43). Testicular cancer was upgraded to probable because it had the highest summary risk estimate (SRE = 2.02; 95% CI = 1.30–3.13). Eight additional cancers were listed as having a “possible” association with firefighting. **Conclusions:** Our results confirm previous findings of an elevated metarerelative risk for multiple myeloma among firefighters. In addition, a probable association with non-Hodgkin lymphoma, prostate, and testicular cancer was demonstrated.

**Review:**

- *Likelihood of Cancer Risk.* Statistically significant increases in cancer risks among firefighters were evaluated as the likelihood for cancer risk given a three-criteria assessment. The three criteria included “pattern of meta-relative risk association,” “study type,” and “consistency” among studies.
- 28 studies were used in their review
- The meta-analysis and criteria assessment designate the likelihood of cancer among firefighters as probable for multiple myeloma and prostate cancer.
- See APPENDIX A-14: TABLES FROM [LEMASTERS 2006] for tabular results
- These findings of an association of firefighting with significant increased risk for specific types of cancer raise red flags and should encourage further development of innovative comfortable protective equipment allowing firefighters to do their jobs without compromising their health. Studies are especially needed that better characterize the type and extent of exposures to firefighters.

**19. Bates MN. (2007) Registry-Based Case–Control Study of Cancer in California Firefighters. Am. J. Ind. Med. 50:339–344.**

**Summary/Background:** There is no consensus whether firefighters are at increased cancer risk for particular cancers. Previous studies have been small, mostly investigated cancer mortality, and suggested increased risks for brain, bladder, testicular, prostate, thyroid and colo-rectal cancers, leukemia, and melanoma. Methods Records of all male cancers registered in California during 1988–2003 were obtained. Firefighters were identified from occupation and industry text fields. Logistic regression analysis used other cancers as controls. Results Of the 804,000 eligible records, 3,659 had firefighting as their occupation. Firefighting was associated with testicular cancer (odds ratio 1.54, 95% confidence interval: 1.18–2.02), melanoma (1.50, 1.33–1.70), brain cancer (1.35, 1.06–1.72), esophageal cancer (1.48, 1.14–1.91), and prostate cancer (1.22, 1.12–1.33). Conclusions Use of other-cancer controls and lack of an occupational history may have biased relative risks towards the null. However, this study, which contained more firefighter cancers than any previous epidemiologic study, produced evidence supporting some prior hypotheses.

### Review:

- Firefighters are exposed to numerous combustion products. These include polycyclic aromatic hydrocarbons (PAHs), formaldehyde, benzene, chromium compounds, dioxins, asbestos, particulates and arsenic, all of which are known or strongly suspected carcinogens [IARC, 1995; Wogan et al., 2004].
- Mortality studies have suggested firefighters may be at risk for, in particular, brain, bladder and colo-rectal cancers, leukemia, non-Hodgkin's lymphoma, multiple myeloma, and malignant melanoma [Howe and Burch, 1990; Golden et al., 1995; Guidotti, 1995; Haas et al., 2003; LeMasters et al., 2006].
- More recent studies examining cancer incidence in firefighters have suggested increased risks for testicular and thyroid cancers, cancers with low fatality rates, may also occur [Bates et al., 2001; Stang et al., 2003; Ma et al., 2006].
- As a result of the increasing use of new building materials, particularly synthetic polymers, firefighter combustion product exposures may have been changing both qualitatively and quantitatively in the last few decades [Guidotti, 1995]. Therefore, the results of the firefighter studies carried out in the 1970s and 1980s may no longer be relevant to the more recent generation of firefighters.
- The objective of this study was to use these text fields to examine whether they provided evidence that California firefighters were at increased cancer risk relative to other occupations, particularly for the cancer types that have previously been linked with firefighting.
- Anonymized records of all male cancers registered by the California Cancer Registry for 1988–2003 were obtained from the Registry. These records included text fields for occupation and industry, tumor classification variables, demographic variables (age, race, sex, and county and zip code of residence) and a variable for socio-economic status.
- There were 1.1 million records of male cancer cases obtained. Of these, 140,000 (13%) were discarded because of no recorded occupation or industry. A total of 804,107 of the remaining subjects aged 21–80 at cancer diagnosis were retained for this analysis. Of these, 3,659 had firefighting recorded as their main occupation (including retired firefighters).
- See APPENDIX A-15: TABLES AND FIGURES FROM [BATES 2007] for tabular results.

- Most notably the analysis supports previous results that firefighting may be associated with cancers of the testes [Bates et al., 2001; Stang et al., 2003; Ma et al., 2006], prostate [Grimes et al., 1991; Demers et al., 1994] and brain [Vena and Fiedler, 1987; Grimes et al., 1991; Demers et al., 1992; Aronson et al., 1994; Burnett et al., 1994], and melanoma of the skin [Sama et al., 1990; Bates et al., 2001]. There is also evidence of an association with esophageal cancer and possibly leukemia.
- In conclusion, this study has added to the evidence that firefighters are at increased risk for certain cancers, particularly testicular and brain cancers and melanoma of the skin. However, final resolution of the question of whether firefighters are at increased occupational cancer risk will probably require a large occupational cohort study followed by an appropriate nested case-control study (probably with several cancer endpoints) that combines several exposure assessment methods, including work records and questionnaires to collect detailed covariate data. However, reconstruction of firefighting exposure histories will be challenging. Most of the approximately 25 other published investigations of cancer in firefighters have been cohort studies and relatively small. To date, none of these cohort studies has been followed by a nested case-control study.

## **20. URS Corporation. (2004) Passive FTIR Phase I Testing of Simulated and Controlled Flare Systems. Austin, TX.**

**Summary:** The Texas Commission on Environmental Quality (TCEQ) is working to improve emission estimates for flares. Currently, these estimates are based on emission factors that were derived from limited data obtained as part of EPA-sponsored testing in 1980. Flare emissions may vary based on actual flare operation, and there may be more variables that affect flare operation than were identified in the 1980 studies. Thus, it is desirable to be able to determine speciated emissions and combustion efficiency during actual operation. Therefore, the TCEQ has contracted the University of Houston (UH) and URS Corporation (URS) to evaluate the feasibility of Passive Fourier Transform Infrared (PFTIR) spectroscopy as a candidate method for measuring flare emissions, and to use those measurements to calculate combustion efficiency of flares based on the following equation: (Cut) In cooperation with TCEQ and UH, the URS teamed with Industrial Monitor and Control Corporation (IMACC) and John Zink Company (John Zink). The team developed a multi-phase study for the purpose of assessing if the PTFIR is a viable candidate method for determining the combustion efficiency and total speciated mass emissions from operating process flares with a known level of accuracy and precision. The first phase of the study was to evaluate the ability of the PFTIR to measure concentrations of simulated flare emissions in a controlled test environment. The second phase will be to evaluate the PFTIR technology on actual process flares operating in the HGA. This report summarizes the results of the Phase I testing.

### **Review:**

- While the topic of this report is not relevant the use of the open path FTIR is rare and this provides information on its implementation and data achieved.
- Rationale for choosing Passive FTIR: Traditional extractive sampling methods generally collect an aliquot of the pollutant gases or species of interest from within a well-mixed exhaust stack prior to their release to the atmosphere. In most cases these exhaust stacks

are equipped with platforms and sampling ports to permit easy access for the sampling equipment and personnel. This permits a variety of continuous or integrated measurement techniques to be used to quantify the emissions from these 1-2 sources. Because the combustion of industrial flares occurs at the flare tip and the exhaust gases are emitted directly to the atmosphere at a height of several hundred feet; use of traditional stack sampling methods for characterizing flare emissions are not practical.

- Passive Fourier Transform Infrared (PFTIR) spectroscopy was selected as a candidate method for sampling flares for three reasons. First, passive remote sensing using PFTIR offers the possibility of characterizing flare emissions non-intrusively and at a distance. This approach eliminates the need for special cones, sampling rakes, and lifting devices to hoist the sampling packages into position over the flare plume. All of these are manpower intensive and logistically complicated. Secondly, PFTIR may be capable of cost effectively quantifying major constituents of the flare emissions in industrial settings. As compared with other types of remote sensing devices, the PFTIR can quantify many compounds simultaneously (many of which are products of complete and incomplete combustion), thus the measurements can be made more cost effectively. Finally, the PFTIR approach may provide a method for directly assessing flare performance continuously and in near real-time. This could be very advantageous when measuring flares that may be over steamed (or air assisted), or when characterizing the effects of wind speed on flare efficiency.
- Report includes a quality assurance plan which may be good to look at.
- Using traditional “active” open path absorption techniques to measure emissions from flare plumes would require transmitting a collimated beam of infrared light through a plume and then positioning a detector on the opposite side of the flare plume to detect the amount of energy absorbed by those compounds of interest. In this case, the specific wavelengths absorbed are indicative of the presence of specific compounds being present and the amount of light that is absorbed is proportional to the concentration of these species. The use of this approach is further complicated by the fact that the plume may change its direction of travel (relative to the light source) because of prevailing winds, thus requiring periodic re-alignment of the “active” light source and detector. While the use of “active” open path monitoring techniques might be used to characterize the emissions from some ground flares, it is impractical for use on elevated flares.
- An alternate approach, and the one employed in this study, is to use PFTIR for characterizing flare plumes. Unlike traditional spectroscopic methods, which rely on detecting the amount of light that is absorbed to identify and quantify the specie(s) present, the PFTIR operates on the principal of analyzing the amount of thermal radiation emitted by hot gases. In this case, the technique is “passive” since no “active” infrared light source is used. Rather, the hot gases of the flare become the infrared source and the PFTIR spectrometer is used to measure the amount of energy radiated from the flare plume. The use of PFTIR is possible because the IR radiation emitted by hot gases has the same pattern of wavelengths or “fingerprints” as the corresponding infrared absorption spectra. Consequently observing a flare from a distance with an IR instrument coupled to a receiver 1-5 telescope, allows for the rapid identification and quantification of the species in the flare plume. In this case, the signature arising from the hot gases is proportional to the concentration of the gas and to its temperature. Therefore, to conduct PFTIR measurements, the temperature must be deduced from the data, in addition to the

concentration. This type of measurement also requires that the PFTIR be calibrated in absolute units of radiance (watts/cm<sup>2</sup>/ster/cm<sup>-1</sup>) using a black body radiation source.

- Radiant emission signal levels were analytically simulated to provide estimates of the PFTIR signal levels that would be encountered in the field measurement program. To predict signal levels from a flare, radiant signature spectra for all significant chemical species were generated using a high temperature version of the HITRAN atlas in conjunction with rigorous software codes capable of constructing spectra from this atlas. Signal levels for all planned plume generator tests, defined in Section 4 of this report, were simulated.
- To determine minimum detection limits for various species, laboratory simulations were conducted, as discussed above, for several chemicals at specific concentrations and at three temperatures: 150oC, 225oC, and 232oC.
- Initially, the PFTIR system had to be calibrated to determine the radiance levels or equivalently the concentrations of the target compounds that the PFTIR instrument could detect. The calibration used a NIST traceable blackbody (as discussed in Section 4.1.4 Passive FTIR) because it has a known emissivity (0.95) and an accurately known temperature, it has a known radiance output. The calibration of the PFTIR provides a spectral response function for the instrument giving the radiance input per volt of system output. If the noise level of the PFTIR is measured, this noise level can be converted to a noise equivalent radiance or the noise limited minimum detectable gas concentration.
- To determine the PFTIR noise level, the black body source was replaced by a liquid nitrogen cooled “cold plate.” The spectrum measured with this cold plate was considered the system noise level. The RMS noise levels seen in each of the three major analysis bands were: 1.33X10<sup>-8</sup> at 1000 to 1025 cm<sup>-1</sup>, 1.70X10<sup>-8</sup> at 2500 to 2600 cm<sup>-1</sup> and 3.3X10<sup>-8</sup> at 3300 to 3543 cm<sup>-1</sup>. Table 5-2 shows the peak radiance levels determined from reference spectra for CO, ethylene, propylene, propane, and butane at specific concentrations and at three temperatures. These radiance levels translate into the noise-limited detections shown in the sixth and seventh columns of the table. Two spectral ranges are shown for propane because its signature is very weak in the 1000 cm<sup>-1</sup> region (that is used for analysis of most other compounds), making it difficult to measure there. Since its band is much stronger in the 3000 cm<sup>-1</sup> region, the detection of propane can be enhanced by using the shorter wavelength (larger wavenumber) band.
- The laboratory simulations showed that noise limited detections of less than 1 part per million per meter of pathlength (ppm-m) should be possible at 225°C for all compounds except propane. The 225°C (498K) condition corresponds to the “high temperature” cases in the plume generator tests. With the detection limits shown for this temperature the maximum detectable efficiency would be 99.96 percent. At 150°C the detection limits are higher so the maximum combustion efficiency detectable is lower at 99.95 percent.
- The controlled flare test was conducted to determine how to apply PFTIR to an actual flare and evaluate measurement performance for the current state of method development. The flare was fueled with commercial grade propane. The combustion air mixed with the fuel by induced entrainment at the flare stack tip. The PFTIR equipment was located at a convenient distance from the flare and oriented to provide a line of sight to the region above the visible flame zone for the measurements. The distance above the visible flame zone varied from near zero to over 2 meters. The PFTIR telescope encompassed a circular field of view in the region of interest 12 inches in diameter. Both



centerline and traverse measurements were made at various times 5-32 during the overall test period. Data for plume efficiency estimates is based on centerline measurements made during four distinct test periods of about 1 to 3 minutes each. The radiance spectral data were captured at approximately 1.5-second intervals and averaged over 30 seconds to represent one “sample data point.” A time series of 30-second averages over four separate test periods was used to generate the controlled flare test data. Table 5-13 summarizes the controlled flare-PFTIR data.

- **Measurement Uncertainty and Quality Control:** One of the goals of the test program was to quantify the uncertainty of PFTIR in measuring speciated emissions, using EFTIR as the reference measurement. Thus, it was necessary that all of the measurements performed be of the highest quality possible, and that the analytical error associated with the measurement device be understood. The uncertainty 5-34 associated with the EFTIR and PFTIR analyses, along with the quality control checks that were incorporated into the test program, are described in the following sections.
- **Measurement Uncertainty:** The uncertainty associated with the measurement of speciated emissions from a flare by PFTIR will be quantified by comparison with the results of the EFTIR measurements. However, there is some uncertainty associated with the analyses used to develop results from both the EFTIR and the PFTIR. A discussion of this analytical uncertainty for the two methods is presented in the following sections.
- See APPENDIX A-16: TABLES AND FIGURES FROM [URS CORPORATION 2004] for tables and figures showing results.

**APPENDIX A-3: TABLES FROM [AUSTIN 2001]**

**TABLE 1. Potential Firefighter Exposures to Combustion Products**

| Compound     | Concentration                           | SD             | Samples <sup>a</sup> | Number of fires | Type of fire          | Sampling method | Author  |
|--------------|---|----------------|----------------------|-----------------|-----------------------|-----------------|---|
| Acetaldehyde | n.d. <sup>b</sup> -8.1 ppm <sup>c</sup> | — <sup>d</sup> | 21                   | 22              | Knockdown             | Polymer tube    | Jankovic et al. (1992)                          |
|              | n.d.-0.9 ppm                            | —              | 4                    | 22              | Inside mask           | Polymer tube    | Jankovic et al. (1992)                          |
|              | n.d.-1.6 ppm                            | —              | 5                    | 22              | Overhaul <sup>e</sup> | Polymer tube    | Jankovic et al. (1992)                          |
|              | 0.34 ppm                                | 0.41           | 96                   | 25              | Overhaul              | DNPH tube       | Bolstad-Johnson et al. (2000)                   |
| Acrolein     | 0.2-15 ppm                              | —              | 29                   | 200             | Municipal             | 13 × Sieve      | Burgess et al. (1979);<br>Tretman et al. (1980) |
|              | 0.1-4 ppm                               | —              | 12                   | 22              | Knockdown             | Polymer tube    | Jankovic et al. (1992)                          |
|              | 0.2 ppm                                 | —              | 1                    | 22              | Overhaul              | Polymer tube    | Jankovic et al. (1992)                          |
|              | 1 ppm                                   | —              | 1                    | 22              | Inside mask           | Polymer tube    | Jankovic et al. (1992)                          |
| Benzene      | 0.123 ppm                               | 0.133          | 96                   | 25              | Overhaul              | DNPH tube       | Bolstad-Johnson et al. (2000)                   |
|              | 0.2-180 ppm                             | —              | 181/197 <sup>f</sup> | 200             | Municipal             | Charcoal        | Burgess et al. (1979);<br>Tretman et al. (1980) |
|              | 8-250 ppm                               | —              | 18/25                | 14              | Municipal             | Detector tube   | Brandt-Rauf et al. (1989)                       |
|              | n.d.-22 ppm                             | —              | 15                   | 22              | Knockdown             | Charcoal        | Jankovic et al. (1992)                          |
| Benzaldehyde | n.d.-0.3 ppm                            | —              | 2                    | 22              | Overhaul              | Charcoal        | Jankovic et al. (1992)                          |
|              | n.d.-21 ppm                             | —              | 4                    | 22              | Inside mask           | Charcoal        | Jankovic et al. (1992)                          |
|              | 0.383 ppm                               | 0.425          | 95                   | 25              | Overhaul              | Charcoal        | Bolstad-Johnson et al. (2000)                   |
|              | 0.057 ppm                               | 0.057          | 96                   | 25              | Overhaul              | DNPH tube       | Bolstad-Johnson et al. (2000)                   |

(Table continues on next page)

TABLE 1. Potential Firefighter Exposures to Combustion Products (Continued)

| Compound          | Concentration    | SD    | Samples <sup>a</sup> | Number of fires | Type of fire | Sampling method         | Author  |
|-------------------|------------------|-------|----------------------|-----------------|--------------|-------------------------|---|
| Carbon dioxide    | 1000–75,000 ppm  | —     | 89                   | 200             | Municipal    | Bag—detector tube       | Burgess et al. (1979); Treitman et al. (1980) |
|                   | 350–5410 ppm     | —     | 20                   | 22              | Knockdown    | Bag—FTIR                | Jankovic et al. (1992)                        |
|                   | 130–1420 ppm     | —     | 7                    | 22              | Overhaul     | Bag—FTIR                | Jankovic et al. (1992)                        |
|                   | 460–21,300 ppm   | —     | 28                   | 22              | Inside mask  | Bag—FTIR                | Jankovic et al. (1992)                        |
| Carbon monoxide   | 3–1000 ppm       | —     | 90                   | 90              | Municipal    | Bag—Ecolyzer            | Gold et al. (1978)                            |
|                   | 15–5000 ppm      | —     | 49                   | 200             | Municipal    | Bag—Ecolyzer            | Burgess et al. (1979); Treitman et al. (1980) |
|                   | n.d.–15,000 ppm  | —     | 75                   | 75              | Municipal    | Detector tube           | Lowry et al. (1985)                           |
|                   | 11–1087 ppm      | —     | 26                   | 14              | Municipal    | Detector tube           | Brandt-Rauf et al. (1989)                     |
| Carboxyhemoglobin | 5–1900 ppm       | —     | 33                   | 22              | Knockdown    | Bag—FTIR                | Jankovic et al. (1992)                        |
|                   | 5–82 ppm         | —     | 7                    | 22              | Overhaul     | Bag—FTIR                | Jankovic et al. (1992)                        |
|                   | <1–105 ppm       | —     | 6                    | 22              | Inside mask  | Bag—FTIR                | Jankovic et al. (1992)                        |
|                   | n.d.–17 ppm      | —     | 60                   | 1               | Forest fire  | Detector tube           | Kelly (1991)                                  |
|                   | 52.6 ppm         | 66    | 65                   | 25              | Overhaul     | Metrosonics 4-gas meter | Bolstad-Johnson et al. (2000)                 |
|                   | 2.76–7.3%        | —     | 8                    | 5-mo means      | Municipal    | Nonsmoking              | Sammons and Coleman (1974)                    |
| Formaldehyde      | 3.3% (3.4–13.2%) | 1.6   | 3                    | 3               | Municipal    | Nonsmoking              | Loke et al. (1976)                            |
|                   | 2.45%            | 2.5   | 519                  | 124             | Municipal    | Nonsmoking + mask       | Radford and Levine (1976)                     |
|                   | 1.4–9.1%         | —     | 55                   | —               | Municipal    | Nonsmoking              | Stewart et al. (1976)                         |
| Formaldehyde      | 0.4–8.3 ppm      | —     | 6/24                 | 14              | Municipal    | Detector tube           | Brandt-Rauf et al. (1988)                     |
|                   | n.d.–8 ppm       | —     | 16                   | 22              | Knockdown    | Polymer tube            | Jankovic et al. (1992)                        |
|                   | n.d.–0.4 ppm     | —     | 5                    | 22              | Overhaul     | Polymer tube            | Jankovic et al. (1992)                        |
|                   | n.d.–0.3 ppm     | —     | 5                    | 22              | Inside mask  | Polymer tube            | Jankovic et al. (1992)                        |
|                   | 0.25 ppm         | 0.252 | 96                   | 25              | Overhaul     | DNPH tube               | Bolstad-Johnson et al. (2000)                 |

|                    |                         |       |       |     |           |                            |  |
|--------------------|-------------------------|-------|-------|-----|-----------|----------------------------|--|
| Glutaraldehyde     | 0.046 ppm               | 0.04  | 96    | 25  | Overhaul  | DNPH tube                  | Bolstad-Johnson et al. (2000)                    |
| Hydrogen chloride  | 18-150 ppm              | —     | 5/90  | 90  | Municipal | 13× Sieve                  | Gold et al. (1978)                               |
|                    | 1-200 ppm               | —     | 69    | 200 | Municipal | 13× Sieve                  | Burgess et al. (1979);<br>Treitman et al. (1980) |
|                    | 0-40 ppm                | —     | 7/75  | 75  | Municipal | Detector tube              | Lowry et al. (1985)                              |
|                    | 2.17-13.3 ppm           | —     | 2/19  | 14  | Municipal | Detector tube              | Brandt-Rauf et al. (1988)                        |
|                    | n.d.-8.5 ppm            | —     | 2     | 22  | Knockdown | Silica gel tube            | Jankovic et al. (1992)                           |
|                    | 0.99 mg/m <sup>3</sup>  | 1.1   | 95    | 25  | Overhaul  | ORBO 53 tube               | Bolstad-Johnson et al. (2000)                    |
| Hydrogen cyanide   | 0.02-0.89 ppm           | —     | 43/90 | 90  | Municipal | Ascarite                   | Gold et al. (1978)                               |
|                    | 0.1-4 ppm               | —     | 13    | 200 | Municipal | Ascarite                   | Burgess et al. (1979);<br>Treitman et al. (1980) |
|                    | n.d.-40 ppm             | —     | 9/75  | 75  | Municipal | Detector tube              | Lowry et al. (1985)                              |
|                    | 0.8-75 ppm              | —     | 10/26 | 14  | Municipal | Detector tube              | Brandt-Rauf et al. (1988)                        |
|                    | n.d.-23 ppm             | —     | 12    | 22  | Knockdown | Soda lime tube             | Jankovic et al. (1992)                           |
|                    | n.d.-0.4 ppm            | —     | 3     | 22  | Overhaul  | Soda lime tube             | Jankovic et al. (1992)                           |
|                    | <1.0 mg/m <sup>3</sup>  | —     | 25    | 25  |           | Soda lime tube             | Bolstad-Johnson et al. (2000)                    |
| Hydrogen fluoride  | 0.2-7 mg/m <sup>3</sup> | —     | 8     | 22  | Knockdown | Silica gel tube            | Jankovic et al. (1992)                           |
| Isovaleraldehyde   | 0.07 ppm                | 0.038 | 96    | 25  | Overhaul  | DNPH tube                  | Bolstad-Johnson et al. (2000)                    |
| Methylene chloride | 0.28 ppm                | —     | 1     | 14  | Municipal | Charcoal                   | Brandt-Rauf et al. (1988)                        |
| Nitrogen dioxide   | 0.02-0.89 ppm           | —     | 8/90  | 90  | Municipal | 13× sieve                  | Gold et al. (1978)                               |
|                    | 0.2-10 ppm              | —     | 33    | 200 | Municipal | 13× sieve                  | Burgess et al. (1979);<br>Treitman et al. (1980) |
|                    | 0.13 ppm                | 0.21  | 65    | 25  | Overhaul  | Metrosonics<br>4-gas meter | Bolstad-Johnson et al. (2000)                    |

(Table continues on next page)

TABLE 1. Potential Firefighter Exposures to Combustion Products (Continued)

| Compound                  | Concentration   | SD          | Samples <sup>a</sup> | Number of fires | Type of fire           | Sampling method                         | Author   |
|---------------------------|---|-------------|----------------------|-----------------|------------------------|---|--|
| PAHs Mixture <sup>b</sup> | 0.262 mg/m <sup>3</sup>                                 | —           | 3                    | 22              | Knockdown              | Polymer tubes + filter                  | Jankovic et al. (1992)   |
|                           | 0.006 mg/m <sup>3</sup>                                 | —           | 3                    | 22              | Overhaul               | polymer tubes + filter                  | Jankovic et al. (1992)   |
| Benzo(e)pyrene            | 0.548 mg/m <sup>3</sup>                                 | 0.019 (avg) | 88                   | 25              | Overhaul               | ORBO 43/PTFE filter                     | Bolstad-Johnson et al. (2000)  |
|                           | 0.022 mg/m <sup>3</sup>                                 | —           | 3                    | 22              | Knockdown              | Polymer tubes + filter                  | Jankovic et al. (1992)   |
| Acenaphthylene            | 0.001 mg/m <sup>3</sup>                                 | —           | 3                    | 22              | Overhaul               | Polymer tubes + filter                  | Jankovic et al. (1992)   |
|                           | 0.451 mg/m <sup>3</sup>                                 | 0.536       | 88                   | 25              | Overhaul               | ORBO 43/PTFE filter                     | Bolstad-Johnson et al. (2000)  |
| Naphthalene               | 0.223 mg/m <sup>3</sup>                                 | 0.101       | 88                   | 25              | Overhaul               | ORBO 43/PTFE filter                     | Bolstad-Johnson et al. (2000)  |
|                           | 4–750 mg/m <sup>3</sup><br>20–20,000 mg/m <sup>3</sup>  | —           | 20<br>64             | 90<br>200       | Municipal<br>Municipal | 25 mm glass filter<br>Fiberglass filter | Gold et al. (1978)<br>Burgess et al. (1979);<br>Trietman et al. (1980) |
| Particulates              | 10.1–344 mg/m <sup>3</sup>                              | —           | 5                    | 14              | Municipal              | Glass fiber                             | Brandt-Rauf et al. (1988)  |
|                           | n.d.–560 mg/m <sup>3</sup><br>n.d.–45 mg/m <sup>3</sup> | —           | 4<br>4               | 22<br>22        | Knockdown<br>Overhaul  | Cascade impactor<br>Cascade impactor    | Jankovic et al. (1992)<br>Jankovic et al. (1992)                       |

|                           |  |           |          |         |                         |   |  |
|---------------------------|--|-----------|----------|---------|-------------------------|---|--|
| Particulates (respirable) | 3.70 mg/m <sup>3</sup><br>8.01 mg/m <sup>3</sup> | —<br>8.02 | 25<br>93 | 1<br>25 | Forest fire<br>Overhaul | PVC filter<br>PVC filter                    | Kelly (1991)<br>Bolstad-Johnson et al.<br>(2000) |
| Perchloroethylene         | 0.064–0.138 ppm                                  | —         | 3        | 14      | Municipal               | Charcoal                                    | Brandt-Rauf et al.<br>(1988)                     |
| Sulphur dioxide           | 0.4–41.7 ppm                                     | —         | 12/26    | 14      | Municipal               | Detector tube                               | Brandt-Rauf et al.<br>(1988)                     |
|                           | 0.6–3.0 ppm<br>1.6 ppm                           | —<br>2.06 | 26<br>65 | 1<br>25 | Forest fire<br>Overhaul | Detector tube<br>Metrosonics<br>4-gas meter | Kelly (1991)<br>Bolstad-Johnson et al.<br>(2000) |
| Toluene                   | 0.16–0.28 ppm                                    | —         | 3        | 14      | Municipal               | Charcoal                                    | Brandt-Rauf et al.<br>(1988)                     |
| Trichloroethylene         | 0.112–0.181 ppm                                  | —         | 2        | 14      | Municipal               | Charcoal                                    | Brandt-Rauf et al.<br>(1988)                     |
| Trichlorophenol           | 0.1 ppm  | —         | 1        | 14      | Municipal               | Charcoal                                    | Brandt-Rauf et al.<br>(1988)                     |
| Xylene                    | 0.06 ppm   | —         | 3        | 22      | Knockdown               | Charcoal                                    | Jankovic et al. (1992)                           |

Note. Some of the studies cited also sampled other substances such as metals and asbestos fibers not mentioned in the table.

<sup>a</sup>Number of usable samples.

<sup>b</sup>Not detected.

<sup>c</sup>Parts per million.

<sup>d</sup>Information not given in the original article.

<sup>e</sup>Not all fires involved overhaul.

<sup>f</sup>(Number of samples where the chemical was detected)/(total number of samples).

<sup>g</sup>The sum of 13 polycyclic aromatic hydrocarbons (acenaphthalene, anthracene, benzo[a]anthracene, benzo[a]pyrene, benzo[b]fluoranthene, benzo[ghi]perylene, benzo[k]fluoranthene, chrysene, dibenz[a,h]anthracene, fluoanthracene, indeno[1,2,3-cd]pyrene, phenanthrene, pyrene).

**APPENDIX A-4: TABLES FROM [BOLSTAD-JOHNSON 2000]**

**TABLE I. Analytical Limits of Detection**

| Analyte                 | NIOSH Method | Analytical Detection Limit | Sample Media <sup>§</sup>        | Flow Rate  | Calculated Sensitivity per Sample <sup>¶</sup> |
|-------------------------|--------------|----------------------------|----------------------------------|------------|--|
| <b>Area Samples</b>     |              |                            |                                  |            |  |
| Asbestos                | 7400         | 7 fibers/field             | 0.8 µm, 25 mm MCE filter         | 11 L/min   | 0.03 f/cc                                      |
| Cadmium (Cd)            | 7300         | 0.005 µg                   | 0.8 µm, 37 mm MCE filter         | 2.0 L/min  | 0.000125 mg/M <sup>3</sup>                     |
| Chromium (Cr)           | 7300         | 0.05 µg                    | 0.8 µm, 37 mm MCE filter         | 2.0 L/min  | 0.00125 mg/M <sup>3</sup>                      |
| Lead (Pb)               | 7300         | 0.025 µg                   | 0.8 µm, 37 mm MCE filter         | 2.0 L/min  | 0.00625 mg/M <sup>3</sup>                      |
| Total dust              | 0500         | 0.05 mg                    | 5 µm, 37 mm PVC filter           | 4.0 L/min  | 0.00625 mg/M <sup>3</sup>                      |
| <b>Personal Samples</b> |              |                            |                                  |            |  |
| Acetaldehyde            | 2532         | 2 µg                       | DNPH tube (SKC 226-118)          | 0.5 L/min  | 0.2 mg/M <sup>3</sup>                          |
| Acrolein                | 2532         | 0.4 µg                     | DNPH tube (SKC 226-118)          | 0.5 L/min  | 0.04 mg/M <sup>3</sup>                         |
| Benzaldehyde            | 2532         | 2 µg                       | DNPH tube (SKC 226-118)          | 0.5 L/min  | 0.2 mg/M <sup>3</sup>                          |
| Benzene                 | 1501         | 2 µg/tube                  | small charcoal tube (SKC 226-01) | 0.2 L/min  | 0.5 mg/M <sup>3</sup>                          |
| Ethyl benzene           | 1501         | 20 µg/tube                 | small charcoal tube (SKC 226-01) | 0.2 L/min  | 5.0 mg/M <sup>3</sup>                          |
| Formaldehyde            | 2532         | 0.4 µg                     | DNPH tube (SKC 226-118)          | 0.5 L/min  | 0.04 mg/M <sup>3</sup>                         |
| Glutaraldehyde          | 2532         | 0.2 µg                     | DNPH tube (SKC 226-118)          | 0.5 L/min  | 0.02 mg/M <sup>3</sup>                         |
| Hydrochloric acid       | 7903         | 2 µg/tube                  | ORBO 53 tube                     | 0.5 L/min  | 0.2 mg/M <sup>3</sup>                          |
| Hydrogen cyanide        | 6010         | 2 µg/tube                  | soda lime tube (SKC 226-28)      | 0.18 L/min | 1 mg/M <sup>3</sup>                            |
| PNAs                    | 5515         | 2 µg/tube                  | PTFE filter/<br>ORBO 43 tube     | 2.0 L/min  | 0.05 mg/M <sup>3</sup>                         |
| Respirable dust         | 0600         | 0.05 mg                    | preweighed PVC filter            | 1.8 L/min  | 3.0 mg/M <sup>3</sup>                          |
| Toluene                 | 1501         | 20 µg/tube                 | small charcoal tube (SKC 226-01) | 0.2 L/min  | 5.0 mg/M <sup>3</sup>                          |
| Xylene                  | 1501         | 20 µg/tube                 | small charcoal tube (SKC 226-01) | 0.2 L/min  | 5.0 mg/M <sup>3</sup>                          |

<sup>¶</sup>Based on a 20-min sample.  
<sup>§</sup>SKC West, Fullerton, Calif.

**TABLE II. Exposure Standards and Guidelines for the Interpretation of Firefighter Exposure Data**

| Chemical                 | OSHA PEL             | ACGIH TLV            | NIOSH REL       | STEL <sup>A</sup>  | IDLH <sup>A</sup> |
|--------------------------|----------------------|----------------------|-----------------|--|-------------------|
| Acetaldehyde             | 200 ppm              | —                    | LF <sup>A</sup> | 25 ppm (C) <sup>B</sup>  | 2000 ppm          |
| Acrolein                 | 0.1 ppm              | —                    | 0.1 ppm         | 0.1 ppm (C) <sup>B</sup><br>0.3 ppm <sup>C</sup>                           | 2 ppm             |
| Asbestos                 | 0.1 f/cc             | 0.1 f/cc             | LF              | —  | —                 |
| Benzene                  | 1 ppm                | 0.5 ppm              | 0.1 ppm         | 2.5 ppm <sup>B</sup><br>1 ppm <sup>C</sup>                                 | 3000 ppm          |
| Benzaldehyde             | —                    | —                    | —               | —  | —                 |
| Carbon monoxide          | 50 ppm               | 25 ppm               | 35 ppm          | 200 ppm (C) <sup>C</sup>   | 1200 ppm          |
| Formaldehyde             | 0.75 ppm             | —                    | 0.016 ppm       | 2 ppm <sup>D</sup><br>0.3 ppm (C) <sup>B</sup><br>0.1 ppm (C) <sup>C</sup> | 20 ppm            |
| Glutaraldehyde           | —                    | —                    | —               | 0.05 ppm (C) <sup>B</sup><br>0.2 ppm (C) <sup>C</sup>                      | —                 |
| Hydrogen chloride        | —                    | —                    | —               | 5 ppm (C) <sup>B-D</sup>   | 50 ppm            |
| Hydrogen cyanide         | 10 ppm               | —                    | —               | 4.7 ppm <sup>C</sup><br>4.7 ppm (C) <sup>B</sup>                           | 50 ppm            |
| Isovaleraldehyde         | —                    | —                    | —               | —  | —                 |
| Nitrogen dioxide         | —                    | 3 ppm                | —               | 5 ppm (C) <sup>B-D</sup><br>1 ppm <sup>C</sup>                             | 20 ppm            |
| Particulates, respirable | 5 mg/M <sup>3</sup>  | 3 mg/M <sup>3</sup>  | —               | —  | —                 |
| Particulates, total      | 15 mg/M <sup>3</sup> | 10 mg/M <sup>3</sup> | —               | —  | —                 |
| Sulfur dioxide           | 5 ppm                | 2 ppm                | 2 ppm           | 5 ppm <sup>B,C</sup>   | 100 ppm           |

<sup>A</sup>IDLH = immediately dangerous to life or health; LF = lowest feasible concentration; C = ceiling (not to be exceeded).

<sup>B</sup>American Conference of Governmental Industrial Hygienists (ACGIH).

<sup>C</sup>National Institute for Occupational Safety and Health (NIOSH).

<sup>D</sup>Occupational Safety and Health Administration.

**TABLE III. Summary of Data on CO, NO<sub>2</sub>, and SO<sub>2</sub> Obtained from Direct-Read Four-Gas Meter**

| Gas                          | Number of Samples | Average Sample Time (min) | Average Sample Conc. | STD DEV | MAX                   | Average Calculated 8-hour TWA <sup>A</sup> | MAX TWA  |
|------------------------------|-------------------|---------------------------|----------------------|---------|-----------------------|--|----------|
| CO                           | 65                | 42.2                      | 52.6 ppm             | 66      | 260 <sup>B</sup> ppm  | 3.95 ppm                                   | 26.9 ppm |
| CO <sup>C</sup>              | 65                | 10                        | 89.5 ppm             | 134     | 671 <sup>B</sup> ppm  | —  | —        |
| NO <sub>2</sub>              | 65                | 42.2                      | 0.24 ppm             | 0.64    | 3.6 ppm               | 0.017 ppm                                  | 0.31 ppm |
| NO <sub>2</sub> <sup>C</sup> | 65                | 10                        | 0.13 ppm             | 0.21    | 0.89 ppm              | —  | —        |
| SO <sub>2</sub>              | 65                | 42.2                      | 1.60 ppm             | 2.06    | 8.69 <sup>D</sup> ppm | 0.114 ppm                                  | 0.71 ppm |
| SO <sub>2</sub> <sup>C</sup> | 65                | 10                        | 2.95 ppm             | 4.91    | 21.7 <sup>D</sup> ppm | —  | —        |

<sup>A</sup>TWA = time-weighted average.

<sup>B</sup>Exceeded NIOSH ceiling—200 ppm.

<sup>C</sup>Average of first 10 min of readings.

<sup>D</sup>Exceeded ACGIH/NIOSH STEL—5 ppm.

**TABLE IV. Summary Data for Nonparticulate Samples**

| Analyte           | Number of Samples Collected | Number of Samples Above LOD | Average Sample Conc.   | STD DEV | MIN                   | MAX                    |
|-------------------|-----------------------------|-----------------------------|------------------------|---------|-----------------------|------------------------|
| Acetaldehyde      | 96                          | 71                          | 0.34 <sup>A</sup> ppm  | 0.41    | 0.041 ppm             | 1.75 <sup>A</sup> ppm  |
| Acrolein          | 96                          | 7                           | 0.123 <sup>B</sup> ppm | 0.133   | 0.013 ppm             | 0.3 <sup>B</sup> ppm   |
| Benzaldehyde      | 96                          | 18                          | 0.057 ppm              | 0.031   | 0.016 ppm             | 0.13 ppm               |
| Formaldehyde      | 96                          | 86                          | 0.25 <sup>C</sup> ppm  | 0.252   | 0.016 ppm             | 1.18 <sup>C</sup> ppm  |
| Glutaraldehyde    | 96                          | 24                          | 0.046 ppm              | 0.04    | 0.005 ppm             | 0.15 <sup>D</sup> ppm  |
| Isovaleraldehyde  | 96                          | 18                          | 0.07 ppm               | 0.038   | 0.02 ppm              | 0.16 ppm               |
| Benzene           | 95                          | 53                          | 0.383 ppm              | 0.425   | 0.07 ppm              | 1.99 <sup>E</sup> ppm  |
| Hydrochloric acid | 95                          | 34                          | 0.99 mg/M <sup>3</sup> | 1.10    | 0.1 mg/M <sup>3</sup> | 3.96 mg/M <sup>3</sup> |
| Hydrogen cyanide  | 25                          | 4 <sup>F</sup>              | —                      | —       | —                     | —                      |

<sup>A</sup>Exceeded NIOSH lowest feasible concentration.

<sup>B</sup>Exceeded ACGIH ceiling 0.1 ppm.

<sup>C</sup>Exceeded NIOSH ceiling 0.1 ppm; exceeded ACGIH ceiling 0.3 ppm.

<sup>D</sup>Exceeded ACGIH ceiling 0.05 ppm.

<sup>E</sup>Exceeded NIOSH STEL 1 ppm.

<sup>F</sup>Above analytical limit of detection but below quantification limit all samples were less than 1.0 mg/M<sup>3</sup>.



**TABLE V. Summary Data for PNA Samples\***

| Analyte                | Number Samples Above LOD | Avg. Sample Conc. (µg/M <sup>3</sup> ) | STD DEV | MIN (µg/M <sup>3</sup> ) | MAX (µg/M <sup>3</sup> ) |
|------------------------|--------------------------|--|---------|--------------------------|--------------------------|
| Acenaphthene           | 2                        | 77.7                                   | 15.8    | 66.5                     | 88.8                     |
| Acenaphthylene         | 34                       | 415.0                                  | 536     | 88                       | 2,440                    |
| Anthracene             | 1                        | 22.2                                   | —       | —                        | —                        |
| Benz(a) anthracene     | 3                        | 24.9                                   | 4.90    | 19.3                     | 27.9                     |
| Benzo(a)pyrene         | 5                        | 33.2                                   | 13.6    | 18.7                     | 50                       |
| Benzo(b)fluoranthene   | 4                        | 22.3                                   | 10.6    | 9.5                      | 34                       |
| Benzo(ghi)perylene     | 2                        | 29.0                                   | 23.3    | 12.5                     | 45.4                     |
| Benzo(k)fluoranthene   | 2                        | 23.8                                   | 1.67    | 22.6                     | 25                       |
| Chrysene               | 1                        | 12.9                                   | —       | —                        | —                        |
| Dibenz(a,h)anthracene  | 2                        | 45.5                                   | 31.6    | 23.2                     | 67.9                     |
| Fluoranthene           | 4                        | 120                                    | 39.9    | 79.1                     | 169                      |
| Fluorene               | 0                        | —                                      | —       | —                        | —                        |
| Indeno(1,2,3-cd)pyrene | 3                        | 19.5                                   | 8.35    | 14.3                     | 29.1                     |
| Naphthalene            | 28                       | 223.0                                  | 101     | 73                       | 540                      |
| Phenanthrene           | 13                       | 24.3                                   | 9.19    | 10.8                     | 40.5                     |
| Pyrene                 | 4                        | 93.1                                   | 83.8    | 13.8                     | 211                      |

\*Total = 88 PNA samples collected.

**TABLE VI. Summary Data for Particulate and Metals (Cd, Cr, Pb) Samples**

| Analyte                 | Number of Samples | Number of Samples above LOD | Ave. Sample Conc.       | STD DEV | MIN                     | MAX                     |
|-------------------------|-------------------|-----------------------------|-------------------------|---------|-------------------------|-------------------------|
| <b>Personal Samples</b> |                   |                             |                         |         |                         |                         |
| Respirable dust         | 93                | 29                          | 8.01 mg/M <sup>3</sup>  | 8.02    | 0.71 mg/M <sup>3</sup>  | 25.7 mg/M <sup>3</sup>  |
| Total chlorides         | 93                | 16                          | 0.232 mg/M <sup>3</sup> | 0.18    | 0.038 mg/M <sup>3</sup> | 0.68 mg/M <sup>3</sup>  |
| Total sulfates          | 93                | 8                           | 0.232 mg/M <sup>3</sup> | 0.20    | 0.062 mg/M <sup>3</sup> | 0.53 mg/M <sup>3</sup>  |
| <b>Area Samples</b>     |                   |                             |                         |         |                         |                         |
| Asbestos                | 46                | 15                          | 0.073 f/cc              | 0.063   | 0                       | 0.2 f/cc                |
| Total dust              | 46                | 22                          | 1.82 mg/M <sup>3</sup>  | 8.73    | 0.364 mg/M <sup>3</sup> | 30.79 mg/M <sup>3</sup> |
| Cadmium                 | 46                | 0                           | —                       | —       | —                       | —                       |
| Chromium                | 46                | 0                           | —                       | —       | —                       | —                       |
| Lead                    | 46                | 2                           | 0.03 mg/M <sup>3</sup>  | —       | 0.03 mg/M <sup>3</sup>  | 0.033 mg/M <sup>3</sup> |

**APPENDIX A-5: TABLES AND FIGURES FROM [BRANDT-RAUF 1988]**

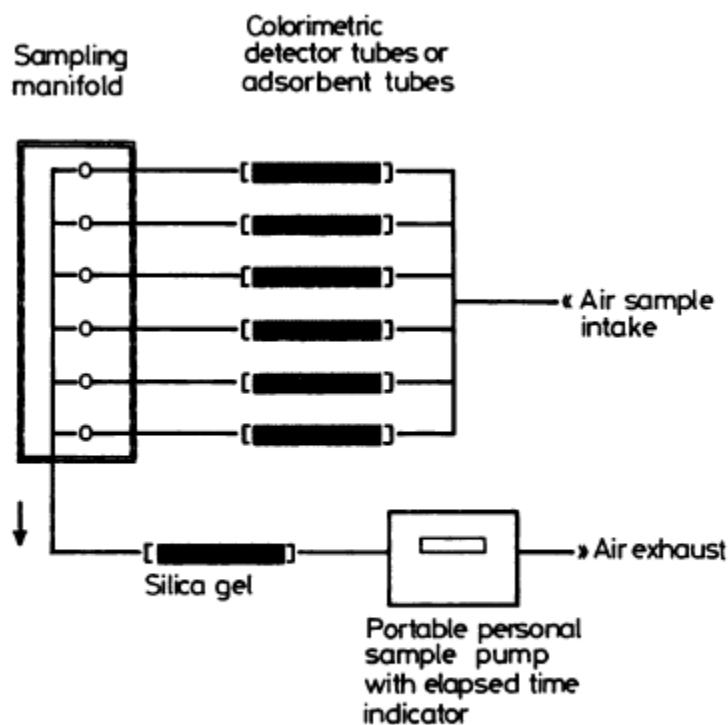
*Health hazards of firefighters: exposure assessments*

Table 1 *Reported concentration ranges for combustion byproducts at fire sites*

| Material          | Reference                |                              |                           |
|-------------------|--------------------------|------------------------------|---------------------------|
|                   | Gold et al <sup>23</sup> | Treitman et al <sup>24</sup> | Lowry et al <sup>26</sup> |
| Carbon monoxide   | 3-1000                   | 15-5000                      | 0-15 000                  |
| Hydrogen chloride | 18-150                   | 1-200                        | 0-40                      |
| Hydrogen cyanide  | 0.02-5                   | 0.1-5                        | 0-40                      |
| Formaldehyde      |                          |                              |                           |
| acetaldehyde      | NA                       | NA                           | 1-15                      |
| Nitrogen dioxide  | 0.02-0.89                | 0.2-10                       | NA                        |
| Carbon dioxide    | NA                       | 1000-60 000                  | NA                        |
| Benzene           | NA                       | 0.2-150                      | 500-1200*                 |
| Particulates      | 4-750                    | 20-20 000                    | NA                        |

All concentrations in ppm except particulates which are in mg/m<sup>3</sup>.  
 \*Reported as total hydrocarbons.  
 NA = Not available.

607



*Schematic diagram of sampling pump with six stage variable orifice manifold and tube holder system carried by firefighters for personal ambient environmental monitoring during fires.*

Table 2 Summary of fire characteristics

| Sample No | Call No | Structural material | Material burning    | SCBA used | Smoke intensity |
|-----------|---------|---------------------|---------------------|-----------|-----------------|
| 1         | 1       | Brick/wood          | Contents only       | No        | Low             |
| 2         |         | Brick/wood          | Contents only       | No        | Low             |
| 3         | 2       | Concrete            | Contents only       | Yes       | Moderate        |
| 4         |         | Concrete            | Contents only       | Yes       | Intolerable     |
| 5         | 3       | Wood                | Building & contents | Partial   | Moderate        |
| 6         |         | Wood                | Building & contents | Partial   | Moderate        |
| 7         | 4       | Wood                | Building & contents | Yes       | High            |
| 8         |         | Wood                | NA                  | Partial   | Moderate        |
| 9         | 5       | Brick/wood          | Building only       | Yes       | NA              |
| 10        | 6       | Wood                | Contents only       | No        | Low             |
| 11        | 7       | Wood                | Building & contents | Partial   | Low             |
| 12        |         | Wood                | Building & contents | Partial   | Moderate        |
| 13        | 8       | NA                  | NA                  | No        | Low             |
| 14        | 9       | Wood                | Building & contents | Yes       | None            |
| 15        |         | Wood                | Building & contents | No        | Low             |
| 16        | 10      | Wood                | Building & contents | Partial   | Low             |
| 17        | 11      | Wood                | Building & contents | Yes       | Intolerable     |
| 18        |         | Wood                | Building & contents | Yes       | Intolerable     |
| 19        |         | Wood                | Building & contents | Yes       | Low             |
| 20        | 12      | Wood                | Building & contents | Yes       | Intolerable     |
| 21        |         | Wood                | Building & contents | Yes       | Moderate        |
| 22        |         | Wood                | Building & contents | No        | Low             |
| 23        |         | Wood                | Building & contents | Yes       | Moderate        |
| 24        | 13      | NA                  | Car                 | No        | Low             |
| 25        |         | NA                  | Car                 | No        | Low             |
| 26        | 14      | Wood                | Building & contents | Partial   | Intolerable     |

SCBA = Self contained breathing apparatus.

Health hazards of firefighters: exposure assessments

Table 3 Colorimetric detector tube sampling results

| Sample No | Call No | Carbon monoxide | Hydrogen chloride | Hydrogen cyanide | Sulphur dioxide | Benzene | Formaldehyde |
|-----------|---------|-----------------|-------------------|------------------|-----------------|---------|--------------|
| 1         | 1       | 41.7            | 0                 | 0                | 0               | 0       | 0            |
| 2         |         | 41.6            | 0                 | 0                | 0               | 0       | 0            |
| 3         | 2       | 800             | 13.3              | 0                | 1.7             | 8.3     | 3.3          |
| 4         |         | 250             | NA                | 75               | 41.7            | 158.3   | NA           |
| 5         | 3       | 16.6            | 0                 | 0                | 0               | 0       | 0            |
| 6         |         | 150             | 0                 | 2.5              | 1.7             | 83.3    | 0            |
| 7         | 4       | 313             | 0                 | 6.3              | 2.5             | 225     | 0            |
| 8         |         | 33.3            | 0                 | 0.8              | 0.4             | 16.6    | 0            |
| 9         | 5       | 250             | 0                 | 10               | 2.5             | 250     | 0            |
| 10        | 6       | 41.7            | 0                 | 0                | 0               | 41.7    | 0            |
| 11        | 7       | 100             | 0                 | 0                | 0.2             | 54.2    | 0            |
| 12        |         | 25              | 0                 | 0                | 0               | 0       | 0            |
| 13        | 8       | 100             | 0                 | 0                | 0               | NA      | 0            |
| 14        | 9       | 483.3           | 0                 | 10               | 2.5             | 166.7   | 0.4          |
| 15        |         | 166.7           | NA                | 5                | 2.5             | 29.2    | 0.8          |
| 16        | 10      | 62.5            | 0                 | 0                | 0               | 50      | 0            |
| 17        | 11      | 316.7           | 0                 | 0                | 0               | 141.7   | 8.3          |
| 18        |         | 333.3           | NA                | 0                | 0               | 0       | 0            |
| 19        |         | 18.5            | NA                | 0                | 0               | 0       | 0            |
| 20        | 12      | 833.3           | 0                 | 6.7              | 1.7             | 33.3    | 0.4          |
| 21        |         | 41.7            | NA                | 0                | 0               | 50      | 0            |
| 22        |         | 17              | 0                 | 0                | 0               | 0       | NA           |
| 23        |         | 833.3           | NA                | 4.2              | 1.7             | 25      | 0.1          |
| 24        | 13      | 11.4            | NA                | 0                | 0               | 34.1    | 0            |
| 25        |         | 34.1            | 0                 | 0                | 0               | 22.7    | 0            |
| 26        | 14      | 1087            | 2.17              | 8.7              | 1.1             | 10.9    | 0            |

All concentrations in ppm.

**Table 4** *Charcoal sorbent tube sampling results*

| <i>Call No</i> | <i>Dichlorofluoromethane</i> | <i>Methylene chloride</i> | <i>Trichloroethylene</i> | <i>Chloroform</i> | <i>Perchloroethylene</i> | <i>Toluene</i> | <i>Trichlorophenol</i> |
|----------------|------------------------------|---------------------------|--------------------------|-------------------|--------------------------|----------------|------------------------|
| 9              | 0.67                         | NA                        | 0.112                    | 0.960             | 0.064                    | 0.160          | NA                     |
| 11             | 4.93                         | NA                        | NA                       | NA                | NA                       | NA             | NA                     |
| 12             | 10.1                         | NA                        | NA                       | NA                | 0.138                    | 0.275          | NA                     |
| 12             | 12.1                         | 0.278                     | 0.181                    | 1.92              | 0.074                    | 0.248          | 0.129                  |
| 13             | 1.65                         | NA                        | NA                       | NA                | NA                       | NA             | NA                     |

All concentrations in ppm.

**Table 5** *Particulate filter sampling results*

| <i>Call No</i> | <i>Particulate concentration (mg/m<sup>3</sup>)</i> |
|----------------|---|
| 6              | 10.39   |
| 8              | 10.80   |
| 9              | 344.4   |
| 12             | 10.1  |
| 13             | 38.3  |

**APPENDIX A-6: TABLES FROM [BRYANT 2007]**

**Table 1. Particulate Sampling Results from Some Fire Overhaul and WTC Studies**

| Event             | Description | Particulates                      | Concentration*         | Collection/Analysis Method                                    |
|-------------------|-------------|-----------------------------------|------------------------|---|
| Overhaul[1]       | Air sample  | Respirable dust (personal sample) | 6.18 mg/m <sup>3</sup> | Filter/Gravimetric  |
| Overhaul[2]       | Air sample  | Total dust (area sample)          | 1.82 mg/m <sup>3</sup> | Filter/Gravimetric  |
|                   |             | Respirable dust (personal sample) | 8.01 mg/m <sup>3</sup> | Filter/Gravimetric  |
|                   |             | Asbestos                          | 0.073 fibers/cc        |   |
|                   |             | Lead                              | 0.03 mg/m <sup>3</sup> |   |
| Fire/Overhaul[14] | Air sample  | Smoke                             | -                      | Impinger/ Chemiluminescence<br>Filter/Electron Spin Resonance |
|                   |             | Aerosol                           | -                      | Impinger/ Chemiluminescence<br>Filter/Electron Spin Resonance |

**Table 2. Responses to: “What are the prioritized research needs for direct-reading particulate detectors for first responders?” and “What are the prioritized research needs for assessing firefighter exposures during overhaul?”**

| Priority                                      | Scope  | # Groups |
|---|--|----------|
| Health Effects for Firefighters from Overhaul | The exposure risks of firefighters need to be better understood. This includes an enhanced understanding of dosimetry metrics, including ways to distinguish between chronic and acute exposure, correlations with firefighter activities or procedures and other environmental factors, and dependence on particulate size and composition. Specific questions include: What is the toxicological response to different sizes and compositions of particulates? Considering that particulates may also carry adsorbed gases, how should the hazard be defined with respect to particulates and gases? Do water particles play a role in health effects? What about confounders such as contaminated turnout gear and exposure to truck exhaust that may also affect firefighter health? What are the procedures for overhaul, and how do they affect the timeline for safe operation? | 3        |
| Particulate Characterization in Overhaul      | More comprehensive data are needed on the particle environment associated with real overhaul environments, such as particle size distribution (PSD), number density, and particle composition. A database of what fires actually generate should be developed. The data should address issues of statistical sufficiency and local vs. global measurements.  | 3        |
| Detector Response in Overhaul                 | Improved characterization of the instrument response function is needed to address complications inherent in mixtures, such as variations and combinations of composition and interference with other gas-phase constituents or nuisance backgrounds. For example, how does water affect the measurement and should water droplets be included in the measurement? Instrument sampling efficiency and biases as functions of environmental conditions need to be understood. Multi-metric methods of evaluating performance should be developed to account for the range of particle sources and particle sizes (ultrafines to 10 µm particles). The procedures of overhaul (including timelines) should be defined to guide the development of sampling/measurement strategies that are representative of the activity of the firefighters.   | 3        |
| Demonstration of Benefits                     | Firefighters need to be convinced that it is beneficial to wear a respirator mask or SCBA during overhaul. Demonstration of the benefits that will result from the use of particle detector technology is necessary. Is it worthwhile to do the research? Consider the evidence of adverse health effects from scenarios that are analogous to overhaul, such as events of repeated low-level exposures, below published threshold exposure limits, to hazardous airborne matter.  | 2        |
| Hazard of Overhaul                            | Quantify the respiratory hazard from particulates (and gases) found in the overhaul environment: mass, number concentration, size. This information is necessary to predict the exposures and toxicological response.  | 1        |
| New Filter Cartridge                          | Due to a range of multiple respiratory hazards found in overhaul, a new filter cartridge should be designed for optional respiratory protection for firefighters during overhaul. Features such as an end-of-service indicator should be included.   | 1        |

**APPENDIX A-7: TABLES FROM [BURGESS 2001]**

**TABLE 2**  
Combustion Products Exposure During Overhaul

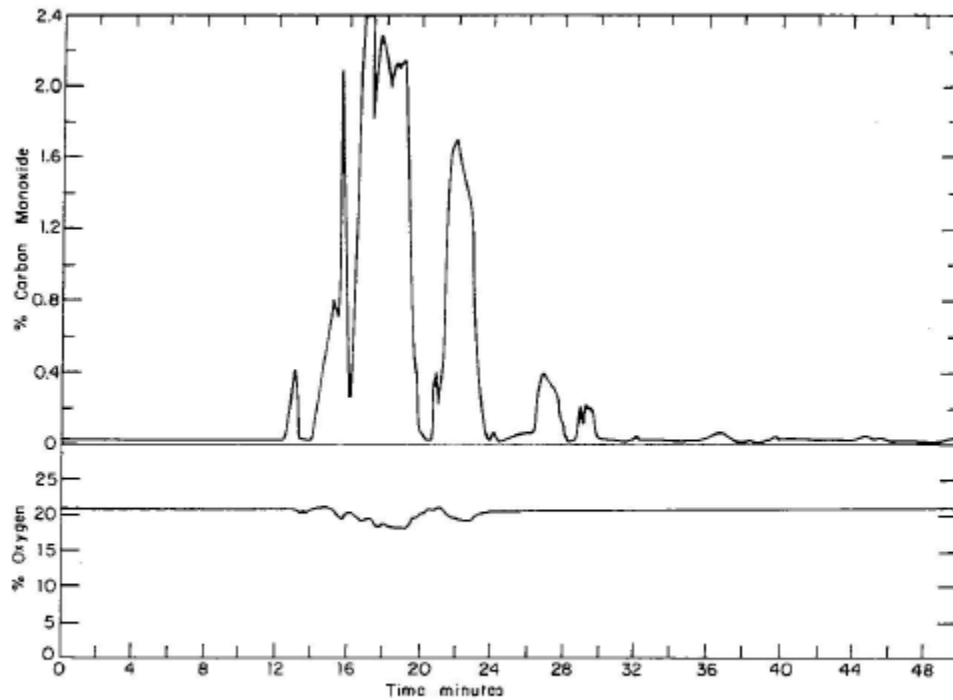
| Analyte*                             | Tucson   |                   |                        | Phoenix  |                   |                        |
|--------------------------------------|----------|-------------------|------------------------|----------|-------------------|------------------------|
|                                      | <i>n</i> | >LOD <sup>†</sup> | Mean ± SD <sup>‡</sup> | <i>n</i> | >LOD <sup>†</sup> | Mean ± SD <sup>‡</sup> |
| Carbon monoxide                      | 18       | 18                | 12.2 ± 10.5            | 13       | 13                | 34.1 ± 34.7            |
| Carboxyhemoglobin (%)                | 25       | 25                | 1.06 ± 2.11            | 26       | 26                | 0.98 ± 0.98            |
| Nitrogen dioxide                     | 18       | 18                | 0.002 ± 0.003          | 13       | 13                | 0.003 ± 0.006          |
| Sulfur dioxide                       | 18       | 18                | 0.448 ± 0.401          | 13       | 13                | 1.52 ± 1.42            |
| Hydrogen cyanide                     | 15       | 15                | 0.893 ± 0.767          | 12       | 12                | 0.785 ± 0.806          |
| Formaldehyde                         | 22       | 21                | 0.109 ± 0.182          | 19       | 19                | 0.257 ± 0.249          |
| Acetaldehyde                         | 22       | 5                 | 0.158 ± 0.037          | 19       | 18                | 0.383 ± 0.494          |
| Acrolein                             | 22       | 0                 |                        | 19       | 1                 | 0.016                  |
| Benzaldehyde                         | 22       | 0                 |                        | 19       | 0                 |                        |
| Glutaraldehyde                       | 22       | 0                 |                        | 19       | 1                 | 0.02                   |
| Isovaleraldehyde                     | 22       | 0                 |                        | 19       | 0                 |                        |
| Hydrochloric acid                    | 23       | 17                | 0.207 ± 0.105          | 19       | 9                 | 0.885 ± 0.615          |
| Sulfuric acid                        | 23       | 5                 | 1.21 ± 2.12            | 19       | 10                | 3.40 ± 3.63            |
| Benzene                              | 23       | 0                 |                        | 20       | 10                | 0.557 ± 0.465          |
| Respirable dust (mg/m <sup>3</sup> ) | 24       | 0                 |                        | 19       | 11                | 6.18 ± 7.80            |

\* Analytes are in parts per million except as otherwise indicated.

<sup>†</sup> Number of samples exceeding the limit of detection (LOD).

<sup>‡</sup> Mean and standard deviations were calculated using only concentrations > LOD.

**APPENDIX A-8: TABLES AND FIGURES FROM [BURGESS 1977]**



*Figure 2—Concentration data on incident no. 26093; tape no. 014; date 9/8/72; first story fire in a block of stores, instrument carried by second alarm company, light smoke, respirators not worn.*

**TABLE I**  
**Carbon Monoxide and Oxygen Measurement Data for Four Typical Incidents**

| INCIDENT NO. | TAPE NO. | TOTAL TIME MINS. | MAXIMUM %CO | TIME            | CO DOSE, %-MINS. |       | MINIMUM %O <sub>2</sub> | TIME                       |
|--------------|----------|------------------|-------------|-----------------|------------------|-------|-------------------------|----------------------------|
|              |          |                  |             | %CO>0.05% MINS. | MIN.             | MAX.  |                         | %O <sub>2</sub> <20% MINS. |
| 24645        | 010      | 10.5             | 0.58        | 3.9             | 0.87-            | 1.08  | 17.2                    | 3.6                        |
| 26093        | 014      | 52               | 2.40        | 13.8            | 10.30-           | 11.30 | 18.0                    | 5.4                        |
| 26360        | 017R     | 14               | 2.70        | 3.3             | 3.94-            | 3.77  | 18.0                    | 2.9                        |
| 1091         | 077      | 55               | 0.72        | 12.5            | 2.44-            | 3.54  | >20                     | 0.0                        |

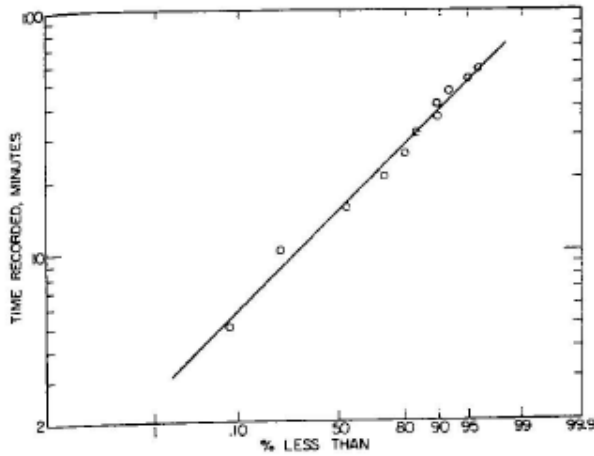


Figure 5 - Time of sampling records.

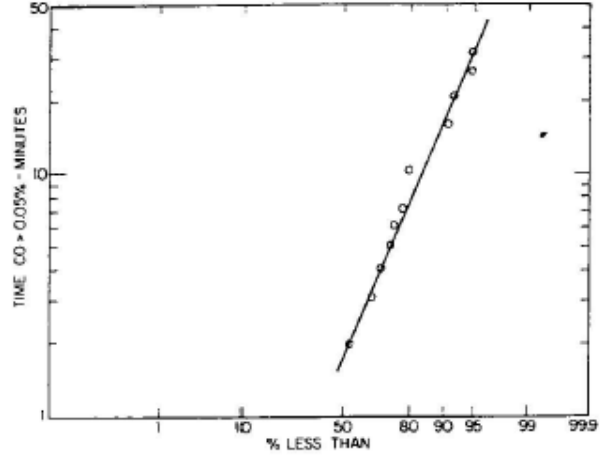


Figure 6 - Time when concentrations of carbon monoxide were greater than 0.05%.

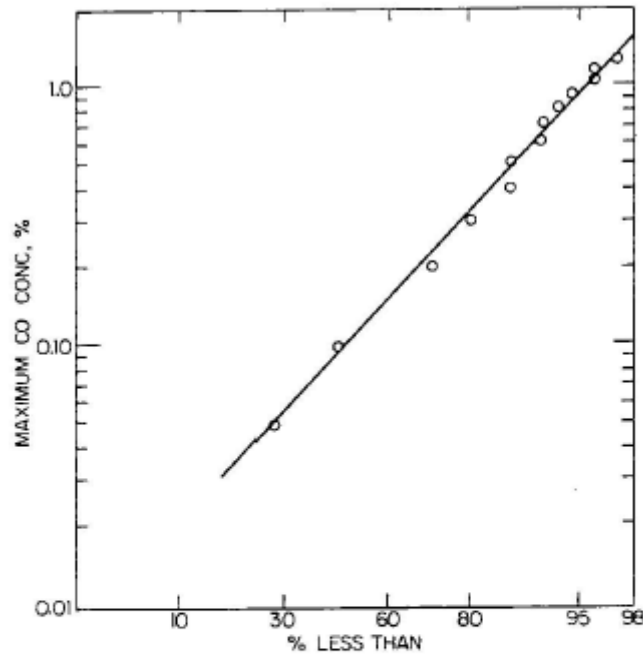


Figure 7 - Distribution of maximum carbon monoxide concentrations.

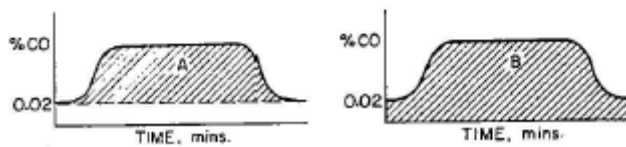


Figure 8 - Method of calculating carbon monoxide dose.



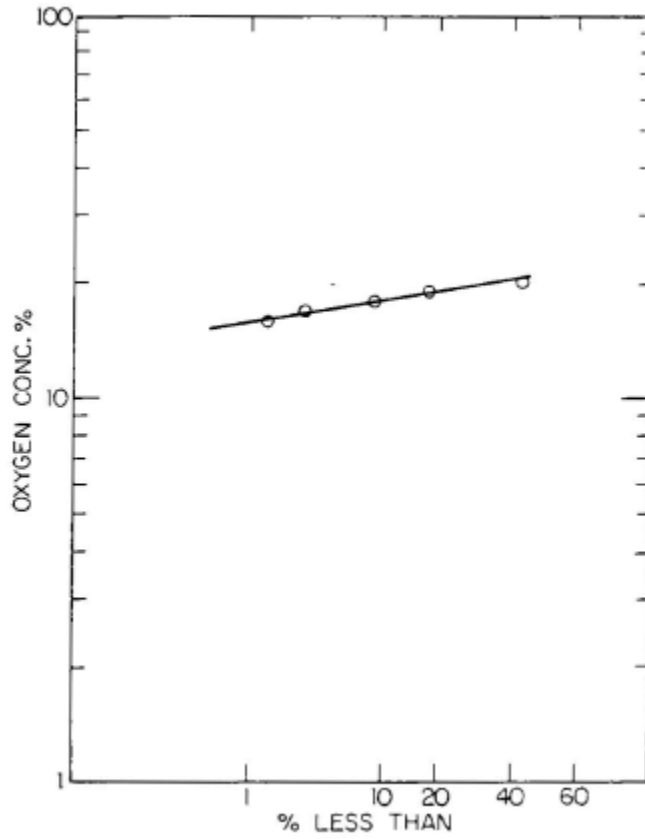


Figure 9 - Distribution of oxygen concentrations.

**APPENDIX A-9: TABLES AND FIGURES FROM [GOLD 1978]**

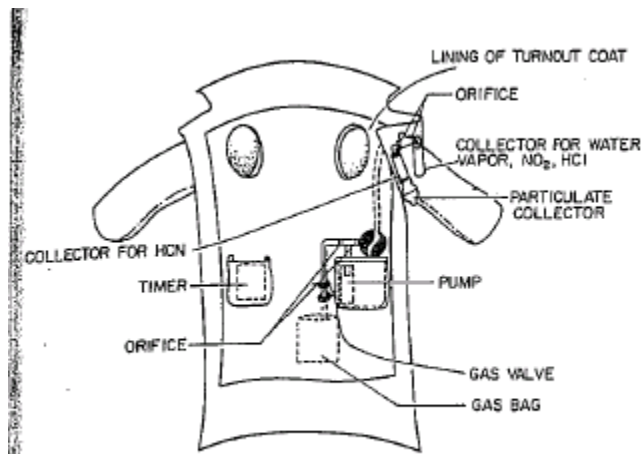


Figure 1 – Turnout coat equipped with sampling system.

**TABLE I**  
Summary of Data on O<sub>2</sub>, CO<sub>2</sub>, HCl and NO<sub>2</sub>

| Gas             | No. samples taken | No. samples in which detected | Comments   |
|-----------------|-------------------|-------------------------------|--|
| O <sub>2</sub>  | 79                | 79                            | Depressed 0.5% in 7 samples<br>0.4% 4<br>0.3% 3<br>0.2% 12<br>0.1% 9 |
| CO <sub>2</sub> | 63                | --                            | Never with certainty above 0.26%                                     |
| HCl             | 90                | 5                             | Concentration (ppm): 18, 32, 75, 128, 150*                           |
| NO <sub>2</sub> | 90                | 8                             | Concentration (ppm): 0.02, 0.29, 0.31, 0.37, 0.59*, 0.63, 0.64, 0.89 |

\*Results questionable because of short sampling time

## APPENDIX A-10: TABLES AND FIGURES FROM [JANKOVIC 1991]

TABLE 1. SAMPLING/ANALYSIS METHODS

| Contaminant                | Sampling system             | Analytical method                   | Approx. detection limit* |
|----------------------------|-----------------------------|-------------------------------------|--------------------------|
| Various gases              | Tedlar bags                 | On-site FTIR                        | variable†                |
| Hydrochloric acid          | Silica gel tube             | Chloride by ion chromatography      | 0.5 mg m <sup>-3</sup>   |
| Hydrofluoric acid          | Silica gel tube             | Fluoride by ion chromatography      | 0.1 mg m <sup>-3</sup>   |
| Nitric acid                | Silica gel tube             | Nitrate by ion chromatography       | 1.3 mg m <sup>-3</sup>   |
| Sulphuric acid             | Silica gel tube             | Sulphate by ion chromatography      | 0.4 mg m <sup>-3</sup>   |
| Hydrogen cyanide           | Soda lime tube              | Cyanide by modified Konig Reaction  | 0.1 ppm                  |
| Acetaldehyde               | Treated porous Polymer tube | Gas chromatography/FID              | 0.1 ppm                  |
| Formaldehyde               | Polymer tube                | Gas chromatography/FID              | 0.1 ppm                  |
| Acrolein                   | Polymer tube                | Gas chromatography/FID              | 0.1 ppm                  |
| Volatile organic compounds | Charcoal tube               | Gas Chromatography/FID/Spectrometry | 0.3 ppm‡                 |
| Fibres                     | Cellulose ester filter      | Phase contrast microscopy           | 0.4 f ml <sup>-1</sup>   |
| Bulk materials             | Hand collected              | Polarized light microscopy          | < 1%                     |
| Particle size distribution | Cascade impactor            | Gravimetric                         | —                        |
| PNAs                       | Teflon filter               | Gas chromatography/FID              | 5 µg m <sup>-3</sup> §   |
| CO                         | Direct-reading meter        | Electrochemical cell                | 1.0 ppm                  |

\*Detection limits calculated based on a 0.5 l. min<sup>-1</sup> flow rate and 15-min sample time unless otherwise noted. These are only approximate since actual sample time and flow rate varied for individual field samples.

†Varies as the signal to noise ratio for each sample.

‡Total hydrocarbons calculated in terms of *n*-nonane.

§Determined for an LOD of 100 ng in a 15-min sample at 1.5 l. min<sup>-1</sup>.



FIG. 2. Hand carried sampling devices.

TABLE 2. DESCRIPTION OF FIRES

| Fire No. | Location                             | Materials/structure                                      | Conditions at area sampling locations |            |
|----------|--------------------------------------|--|---------------------------------------|------------|
|          |                                      |  | Smoke                                 | Temp. (°F) |
| 1        | Fire training centre obstacle course | Wood/kerosene and PVC plastic                            | Dense                                 | < 100      |
| 2        | Fire training centre obstacle course | Wood/kerosene and PVC plastic                            | Dense                                 | < 100      |
| 3        | Fire training centre obstacle course | Wood/kerosene and PVC plastic                            | Dense                                 | < 100      |
| 4        | Training fire                        | Wood/kerosene and PVC plastic and stuffed furniture      | Variable                              | > 100      |
| 5        | Training fire                        | Wood/kerosene and PVC plastic and stuffed furniture      | Variable                              | > 100      |
| 6        | Training fire                        | Wood/kerosene and PVC plastic and stuffed furniture      | Variable                              | > 100      |
| 7        | Urban Fire Department                | Duplex/furnished   | Dense                                 | > 100      |
| 8        | Urban Fire Department                | Tenement/furnished                                       | Dense                                 | < 100      |
| 9        | Urban Fire Department                | Trash fire in concrete stairwell/styrofoam and cardboard | Light                                 | < 100      |
| 10       | Urban Fire Department                | Tenement/mattress and woodwork                           | Light                                 | < 100      |
| 11       | Urban Fire Department                | Vacant tenement fought from outside                      | Variable                              | < 100      |
| 12       | Urban Fire Department                | High-rise apartment/furnished                            | Light                                 | < 100      |
| 13       | Urban Fire Department                | Automobile fire  | Light                                 | < 100      |
| 14       | Urban Fire Department                | Apartment/furnished                                      | None                                  | < 100      |
| 15       | Urban Fire Department                | Basement/wood and paper                                  | Dense                                 | < 100      |
| 16       | Urban Fire Department                | Tenement/rubbish   | Light                                 | < 100      |
| 17       | Urban Fire Department                | Vacant tenement fought from outside                      | Variable                              | < 100      |
| 18       | Urban Fire Department                | Single family residence/ unoccupied                      | Light                                 | < 100      |
| 19       | Urban Fire Department                | Single family residence/ unoccupied                      | Light                                 | < 100      |
| 20       | Urban Fire Department                | Double wide trailer/ furnished as school                 | Dense                                 | > 100      |
| 21       | Urban Fire Department                | Apartment/furnished                                      | Light                                 | < 100      |
| 22       | Urban Fire Department                | Condominium/carpeted but unfurnished                     | Moderate                              | < 100      |

TABLE 3. SUMMARY OF MEASUREMENTS FROM 22 FIRES

| Analyte                        | Knockdown                  | Overhaul                   | Inside-mask    |
|--------------------------------|----------------------------|----------------------------|----------------|
| Carbon monoxide                | BG-1900 ppm                | BG 82 ppm                  | < 1 105 ppm    |
| Carbon dioxide                 | 350-5410 ppm               | 130-1420 ppm               | 460-21 300 ppm |
| Benzene                        | ND-22 ppm                  | ND-0.3 ppm                 | ND 21 ppm      |
| Hydrogen cyanide               | ND-23 ppm                  | ND-0.4 ppm                 | ND             |
| Hydrogen chloride              | ND-8.5 ppm                 | ND                         | NA             |
| Sulphuric acid                 | ND-8.5 mg m <sup>-3</sup>  | ND-0.9 mg m <sup>-3</sup>  | NA             |
| Hydrogen fluoride              | ND-6.4 mg m <sup>-3</sup>  | ND                         | NA             |
| Nitric acid                    | ND 1.8 mg m <sup>-3</sup>  | ND                         | NA             |
| Acrolein                       | ND-3.2 ppm                 | ND-0.2 ppm                 | ND 0.9 ppm     |
| Formaldehyde                   | ND 8 ppm                   | ND-0.4 ppm                 | ND 0.3 ppm     |
| Acetaldehyde                   | ND-8.1 ppm                 | ND-1.6 ppm                 | ND 0.9 ppm     |
| PNAs                           | ND-0.5 mg m <sup>-3</sup>  | ND 0.02 mg m <sup>-3</sup> | NA             |
| Simple asphyxiant (as methane) | ND-289 ppm                 | ND 27 ppm                  | ND 33 ppm      |
| Fibre counts                   | BG-0.21 f ml <sup>-1</sup> | BG-0.36 f ml <sup>-1</sup> | NA             |
| Total particulate              | ND 560 mg m <sup>-3</sup>  | ND 45 mg m <sup>-3</sup>   | NA             |

ND = not detected.  
 BG = background.  
 NA = not analysed.

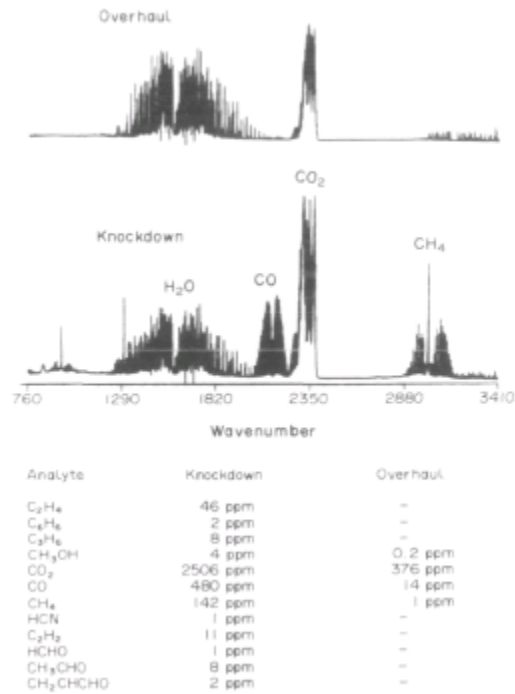


Fig. 15. Comparison of FTIR spectra for knockdown and overhaul.

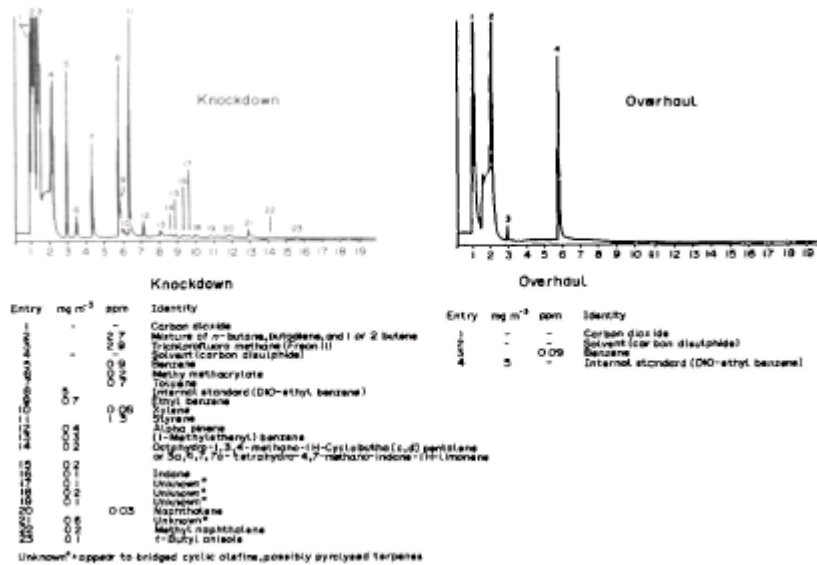


Fig. 16 GC-MS results (fire No. 22).

TABLE 4. CONCENTRATION OF PNAs MEASURED DURING KNOCKDOWN AND OVERHAUL

| Analyte                | Knockdown  |      |                | Overhaul   |      |                |
|------------------------|--|------|----------------|--|------|----------------|
|                        | $\bar{x}$<br>concentration<br>( $\mu\text{g m}^{-3}$ ) | Max. | % on<br>filter | $\bar{x}$<br>concentration<br>( $\mu\text{g m}^{-3}$ ) | Max. | % on<br>filter |
| Acenaphthene           | 63   | 100  | 29             | ND   | —    | —              |
| Phenanthrene           | 54   | 100  | 87             | ND   | —    | —              |
| Anthracene             | 15   | 30   | 96             | ND   | —    | —              |
| Fluoranthene           | 32   | 60   | 100            | 2  | 6    | 100            |
| Pyrene                 | 36   | 70   | 100            | 2  | 6    | 100            |
| Benzo(a)anthracene     | 15   | 30   | 100            | 1  | 3    | 100            |
| Chrysene               | 10   | 20   | 100            | 1  | 3    | 100            |
| Benzo(b)fluoranthene   | 6  | 12   | 100            | ND   | —    | —              |
| Benzo(k)fluoranthene   | 3  | 6    | 100            | ND   | —    | —              |
| Benzo(e)pyrene         | 22   | 40   | 100            | 1  | 4    | 100            |
| Benzo(a)pyrene         | 10   | 20   | 100            | ND   | —    | —              |
| Indeno(1,2,3-cd)pyrene | 10   | 20   | 100            | —  | —    | —              |
| Dibenzo(a,h)anthracene | 3  | 5    | 100            | ND   | —    | —              |
| Benzo(ghi)perylene     | 5  | 10   | 100            | ND   | —    | —              |

**APPENDIX A-11: TABLES FROM [KINES 1996]**

| Table 1<br>Summary of Sampling and Analytical Methods<br>Bureau of Alcohol, Tobacco, and Firearms, Washington, D.C. (HETA 96-0171) |                 |  |  |   |
|--|-----------------|--|--|---|
| Substance  | Flow Rate (Lpm) | Sample Media   | Analytical Method  | Comments  |
| Hydrogen Cyanide   | 0.2             | Soda lime sorbent tubes (600 mg front section/200 mg back section)                               | NIOSH Method No. 6010 modified for analysis on a Technicon Autoanalyzer II-C using visible absorption spectrophotometry  | The glass wool plug that precedes the sorbent was removed prior to sampling   |
| Acids, Inorganic   | 0.2             | Orbo™ 53 sorbent tubes   | NIOSH Method No. 7903, analysis by ion chromatography  | Analysis provides results for hydrofluoric, hydrochloric, nitric, phosphoric, sulfuric, and hydrobromic acids.  |
| Aldehydes  | 0.1             | 10% 2-(hydroxymethyl)piperidine on XAD-2 sorbent tubes (120 mg front section/60 mg back section) | NIOSH Method No. 2539, analysis by GC-FID with modifications   | Analysis provides results for formaldehyde, acetaldehyde, acrolein, and furfural.   |
| Formaldehyde   | 1               | Impinger with 20 mL of 1% sodium bisulfite solution  | NIOSH Method No. 3500, analysis by visible spectroscopy  | This method can detect lower concentrations of formaldehyde than the aldehyde method.   |
| Polycyclic Aromatic Hydrocarbons (PAHs)  | 2.0             | Zefluor filter (37 mm diameter, 2µm pore size), followed by an ORBO 42 sorbent tube              | NIOSH Method No. 5506, analysis by HPLC with modifications   | Filter cassettes and sorbent tube holders were wrapped with aluminum foil to prevent the degradation of PAHs by ultraviolet light.  |
| Qualitative Volatile Organic Compound (VOC) Screen   | 0.02            | Thermal desorption tubes   | Samples analyzed using the Tekmar thermal desorber interfaced directly to a gas chromatograph and a mass spectrometry detector (GC/MS).  | Each thermal desorption (TD) tube contains three beds of sorbent materials: (1) a front layer of Carbotrap C; (2) a middle layer of Carbotrap; and (3) a back section of Carbosieve S-III ‡ |
| Quantitative Analysis for Selected Solvents  | 0.2             | Activated charcoal sorbent tubes (100 mg front section/50 mg back section)                       | Since the major VOCs identified by the GC/MS analysis of the thermal tubes were aromatic hydrocarbons, NIOSH Method No. 1501, analysis by GC-FID with modifications, was used. | Specific VOCs that were quantified included benzene, toluene, xylenes, and styrene.   |
| Elements (metals)  | 2.0             | MCE filter (37 mm diameter, 0.8 µm pore size)  | NIOSH Method No. 7300, analysis by ICP   | This analysis provides results for 27 elements.   |

| Table 1 (continued)<br>Summary of Sampling and Analytical Methods<br>Bureau of Alcohol, Tobacco, and Firearms, Washington, D.C. (HETA 96-0171) |                 |   |   |  |
|--|-----------------|---|---|--|
| Substance  | Flow Rate (Lpm) | Sample Media  | Analytical Method   | Comments   |
| Total Particulate  | 2.0             | Tared PVC filter (37 mm diameter, 0.8 µm pore size)             | NIOSH Method No. 0500, Gravimetric analysis   | Samples were collected with closed-face filter cassettes   |
| Respirable Particulate   | 1.7             | Tared PVC filter (37 mm diameter, 0.8µm pore size)              | NIOSH Method No. 0600, Gravimetric analysis   | Dorr-Oliver nylon cyclone used as particle size selector   |
| Grimm Portable Dust Monitoring   | 1.2             | Dust is collected through a probe directly into the instrument. | The Grimm Dust Monitor is a light scattering aerosol spectrometer designed for real-time particulate measurement with particle size discrimination. | Eight channels collect count information for particle sizes greater than 0.75, 1, 2, 3.5, 5, 7.5, 10, and 15 micrometers (µm). |
| Elemental Organic Carbon   | 2.0             | Quartz-fiber filters (37 mm diameter)                           | A rectangular punch (1.54 cm <sup>2</sup> ) is taken from the quartz filter for a three stage thermal-optical analysis.                             | Samples were collected using a closed-face cassette instead of opened-face.  |

‡ A second type of thermal desorption tube containing one bed of Tenax-GR sorbent material was also used during sampling at the Ft. Belvoir staged fire scenes.

The following are abbreviations which were not spelled out in the table.

- |   |  |
|---|--|
| Lpm = Liters per minute                               | HPLC = High pressure liquid chromatography             |
| mg = milligram  | Zefluor = Teflon® sampling filter                      |
| mm = millimeter                                       | MCE = Mixed cellulose ester                            |
| µm = micrometer                                       | ICP = inductively coupled plasma emission spectrometry |
| cm <sup>2</sup> = square centimeter                   | PVC = Polyvinyl chloride                               |
| GC-FID = Gas chromatography-flame ionization detector |  |



| <b>Table 2</b><br><b>Toxicity and Exposure Criteria Information</b><br>Bureau of Alcohol, Tobacco, and Firearms, Washington, D.C. (HETA 96-0171) |   |  |  |  |
|--|---|--|--|--|
| Compound   | Toxicity Review*  | NIOSH REL  | OSHA PEL   | ACGIH TLV  |
| <b>Hydrogen Cyanide</b>  | Rapid death due to metabolic asphyxiation (impairs the body's ability to utilize oxygen). Less severe exposures cause weakness, headache, confusion, fatigue, and other central nervous system effects. Hydrogen cyanide has been recognized in significant concentrations in some fires, as a combustion product of wool, silk, and many synthetic polymers; it may play a role in toxicity and deaths from smoke inhalation.  | 4.7 ppm STEL (S)   | 10 ppm TWA (S)   | 4.7 ppm ceiling (S)  |
| <b>Benzene</b>   | Acute benzene overexposure can cause central nervous system depression with symptoms such as headache, nausea, and drowsiness. Chronic exposure to benzene has been associated with the depression of the hematopoietic system and is associated with an increased incidence of leukemia and possibly multiple myeloma. NIOSH classifies benzene as a human carcinogen.   | 0.1 ppm TWA<br>1 ppm STEL<br>Ca <sup>1</sup>   | 1 ppm TWA<br>5 ppm STEL  | 0.5 ppm TWA<br>2.5 ppm STEL (S), Ca  |
| <b>Toluene</b>   | Toluene causes central nervous system depression, and can cause acute irritation of the eyes, respiratory tract, and skin. Since it is a defatting solvent, repeated or prolonged skin contact will remove the natural lipids from the skin which can cause drying, fissuring, and dermatitis. Studies have shown that subjects exposed to 100 ppm of toluene for six hours complained of eye and nose irritation, and in some cases, headache, dizziness, and a feeling of intoxication (narcosis). The ACGIH TLV <sup>®</sup> carries a skin notation, indicating that skin exposure contributes to the overall absorbed inhalation dose and potential effects. | 100 ppm TWA<br>150 ppm STEL  | 200 ppm TWA<br>300 ppm ceiling   | 50 ppm TWA (S)   |
| <b>Acids, Inorganic</b>  | Inorganic acids are primary irritants and are corrosive in high concentrations. Inorganic acids will cause chemical burns when in contact with the skin and mucous membranes, and are a particular hazard if contact with the eye should occur. Vapors and mists are respiratory tract irritants, and some inorganic acids may cause pulmonary edema. Discoloration or erosion of the teeth may also occur in exposed workers. Ingestion of inorganic acids will result in severe throat and stomach destruction.   | <b>H<sub>2</sub>SO<sub>4</sub></b><br>1 mg/m <sup>3</sup> TWA<br><br><b>HCl</b><br>5 ppm ceiling<br><br><b>HF</b><br>3 ppm TWA<br>6 ppm STEL | <b>H<sub>2</sub>SO<sub>4</sub></b><br>1 mg/m <sup>3</sup> TWA<br><br><b>HCl</b><br>5 ppm ceiling<br><br><b>HF</b><br>3 ppm TWA | <b>H<sub>2</sub>SO<sub>4</sub></b><br>1 mg/m <sup>3</sup> TWA<br>3 mg/m <sup>3</sup> STEL<br><b>HCl</b><br>5 ppm ceiling<br><br><b>HF</b><br>3 ppm ceiling |
| <b>Formaldehyde</b>  | Formaldehyde is an irritant of the eyes and the respiratory tract; it causes both primary irritation and sensitization dermatitis; and at high levels, it is carcinogenic in experimental animals and is considered a suspected human carcinogen. The first symptoms associated with formaldehyde exposure, at concentrations ranging from 0.1 to 5 parts per million (ppm), are burning of the eyes, tearing, and general irritation of the upper respiratory tract. There is variation among individuals, in terms of their tolerance and susceptibility to acute exposures of the compound.  | 0.016 ppm TWA<br>0.1 ppm ceiling*<br>Ca  | 0.75 ppm TWA<br>2 ppm STEL   | 0.3 ppm ceiling  |
| <b>Acetaldehyde</b>  | Acetaldehyde is an irritant of the eyes, skin, and respiratory tract; at high concentrations it causes narcosis. The irritant effects of the vapor at lower concentrations, such as cough and a burning sensation in the nose, throat, and eyes, usually prevent exposure sufficient to cause central nervous system depression or chronic effects. It is carcinogenic in experimental animals and is considered to be a probable human carcinogen.   | Ca<br><br><i>No numerical REL established</i>  | 200 ppm TWA  | 25 ppm ceiling   |

| Table 2 (continued)<br>Toxicity and Exposure Criteria Information<br>Bureau of Alcohol, Tobacco, and Firearms, Washington, D.C. (HETA 96-0171) |  |                                       |                          |   |
|--|--|---------------------------------------|--------------------------|---|
| Compound   | Toxicity Review*   | NIOSH REL                             | OSHA PEL                 | ACGIH TLV   |
| <b>Acrolein</b>  | Acrolein is an intense irritant of the eyes and upper respiratory tract. Exposure to high concentrations may cause tracheobronchitis and pulmonary edema. The irritation threshold in man is 0.25 ppm to all mucous membranes within 5 minutes. Fatalities have been reported at levels as low as 10 ppm, and 150 ppm is lethal after 10 minutes. The violent irritant effect usually prevents chronic toxicity in man. Prolonged or repeated contact produces skin irritation, burns, and sometimes sensitization.  | 0.1 ppm TWA<br>0.3 ppm STEL           | 0.1 ppm TWA              | 0.1 ppm TWA<br>0.3 ppm STEL<br><i>Notice of Intended Changes: 0.1 ppm ceiling limit</i> |
| <b>Furfural</b>  | Furfural is an irritant of the eyes, mucous membranes, and skin and is a central nervous system depressant. Although the vapor is an irritant, the liquid has a relatively low volatility so that inhalation of significant quantities is unlikely. Exposure to levels of 1.9 to 14 ppm can cause eye and throat irritation and headache. The liquid or vapor is irritating to the skin and may cause dermatitis, allergic sensitization, and photosensitization.  | n/a                                   | 5 ppm TWA<br>(S)         | 2 ppm TWA<br>(S)  |
| <b>Polynuclear Aromatic Hydrocarbons (PAHs)</b>  | Polynuclear aromatic hydrocarbons refers to a set of cyclic organic compounds that consist of two or more fused aromatic rings that may have sulfur, nitrogen, or oxygen in the ring structure and alkyl substituted cyclics. They are often associated with the combustion or pyrolysis of organic matter, especially coal, wood, and petroleum products. PAHs have received considerable attention since some have been shown to be carcinogenic in experimental animals. NIOSH investigators have hypothesized that PAHs with 2 to 3 rings are associated with more irritative effects, while the 4 to 7 ring PAHs may have more carcinogenic and/or mutagenic effects. It is not currently possible to definitively distinguish between these two PAH groups analytically. | None established for PAHs as a class. |                          |   |
| <b>Total Particulate</b>   | Total particulate is a measure of all airborne particulate which was collected on the sample filter. Often the chemical composition of the airborne particulate does not have an established occupational health exposure criterion. It has been the convention to apply a generic exposure criterion in such cases. Formerly referred to as nuisance dust, the preferred terminology for the non-specific particulate ACGIH TLV criterion is now "particulate, not otherwise classified (n.o.c.)," [or "not otherwise regulated" (n.o.r.) for the OSHA PEL].  | n/a                                   | 15 mg/m <sup>3</sup> TWA | 10 mg/m <sup>3</sup> TWA as inhalable fraction  |
| <b>Respirable Particulate</b>  | In contrast to total particulate, a respirable particulate sample uses a selection device to obtain the fraction of the airborne particulate that is small enough to be retained in the respiratory system once inhaled.<br><br>Any conclusions based on respirable (or total) particulate concentrations may be misleading since other potentially toxic substances may be present. These particulate concentrations, along with the results obtained from tests for individual components (such as PAHs and metals) should be considered together when determining the degree of hazard.   | n/a                                   | 5 mg/m <sup>3</sup> TWA  | 3 mg/m <sup>3</sup> TWA   |

| <b>Table 2 (continued)</b><br><b>Toxicity and Exposure Criteria Information</b><br>Bureau of Alcohol, Tobacco, and Firearms, Washington, D.C. (HETA 96-0171) |  |  |  |  |
|--|--|--|--|--|
| Compound   | Toxicity Review*   | NIOSH REL  | OSHA PEL   | ACGIH TLV  |
| <b>Asbestos</b>  | Asbestos causes chronic lung disease (asbestosis), inflammation of the pleura, and certain cancers of the lung, including mesothelioma, and digestive tract. Although NIOSH has established an REL, it considers asbestos (i.e., actinolite, amosite, anthophyllite, chrysotile, crocidolite, and tremolite) to be a potential occupational carcinogen and recommends that exposures be reduced to the lowest feasible concentration.  | 0.1 fiber/cc<br>100-minute<br>TWA<br><br>Ca  | 0.1 fiber/cc<br>TWA<br><br>1.0 fiber/cc<br>excursion   | 0.2 – 2 fibers/cc<br>for various forms<br><i>0.1 fibers/cc for<br/>all forms<br/>(proposed<br/>change), Ca</i>   |
| <b>Carbon Monoxide</b>   | Carbon monoxide (CO) combines with hemoglobin and interferes with the oxygen carrying capacity of blood. Symptoms include headache, drowsiness, dizziness, nausea, vomiting, collapse, myocardial ischemia, and death.   | 35 ppm TWA<br><br>200 ppm ceiling  | 50 ppm TWA   | 25 ppm TWA   |
| <b>Arsenic</b>   | Acute inhalation exposures to arsenic have resulted in irritation of the upper respiratory tract, even leading to nasal perforations. Chronic exposure can cause weakness, nausea, vomiting, diarrhea, skin and eye irritation, hyperpigmentation, thickening of the palms and soles (hyperkeratosis), contact dermatitis, and skin sensitization. Impairment of peripheral circulation and Raynaud's phenomenon have also been reported, and inorganic arsenic is considered carcinogenic.  | 2 µg/m <sup>3</sup> ceiling<br><br>Ca  | 10 µg/m <sup>3</sup> TWA   | 10 µg/m <sup>3</sup> TWA<br><br>Ca   |
| <b>Cadmium</b>   | Cadmium exposures can cause irritation of the lungs, irreversible lung damage, and kidney damage. Occupational exposure to cadmium has been implicated in a significant increase in prostate and respiratory tract cancer. Other consequences of cadmium exposure include anemia, eosinophilia, yellow discoloration of the teeth, rhinitis, occasional ulceration of the nasal septum, damage to the olfactory nerve, and anosmia.  | <i>Lowest feasible<br/>concentration</i><br><br>Ca   | 5 µg/m <sup>3</sup> TWA  | 10 µg/m <sup>3</sup> TWA<br>inhalable<br><br>2 µg/m <sup>3</sup> TWA<br>respirable<br><br>Ca   |
| <b>Chromium</b>  | Chromium (Cr) exists in a variety of chemical forms and toxicity varies among the different forms. For example, elemental chromium is relatively non-toxic. Other chromium compounds may cause skin irritation, sensitization, and allergic dermatitis. In the hexavalent form (Cr(VI)), Cr compounds are corrosive, and possibly carcinogenic. Until recently, the less water-soluble Cr(VI) forms were considered carcinogenic while the water-soluble forms were not considered carcinogenic. Recent epidemiological evidence indicates carcinogenicity among workers exposed to soluble Cr(VI) compounds. Based on this new evidence, NIOSH recommends that all Cr(VI) compounds be considered as potential carcinogens. | Cr(VI)<br>0.001 mg/m <sup>3</sup><br>TWA<br>Ca<br><br>Cr other than<br>Cr(VI)<br>0.5 mg/m <sup>3</sup> TWA | Cr(VI)<br>0.1 mg/m <sup>3</sup><br>ceiling<br><br>Cr(II) &<br>Cr(III)<br>0.5 mg/m <sup>3</sup> TWA<br><br>Cr metal &<br>insoluble salts<br>1 mg/m <sup>3</sup> TWA | Cr(VI)<br>water-soluble<br>0.05 mg/m <sup>3</sup><br>TWA, Ca<br><br>Cr(VI)<br>insoluble<br>0.01 mg/m <sup>3</sup><br>TWA, Ca<br><br>Cr metal &<br>Cr(III)<br>0.5 mg/m <sup>3</sup> TWA |
| <b>Lead</b>  | Chronic lead exposure has resulted in nephropathy (kidney damage), gastrointestinal disturbances, anemia, and neurologic effects. These effects may be felt as weakness, fatigue, irritability, high blood pressure, mental deficiency, or slowed reaction times. Exposure also has been associated with infertility in both sexes and fetal damage.   | <100 µg/m <sup>3</sup> TWA   | 50 µg/m <sup>3</sup> TWA   | 50 µg/m <sup>3</sup> TWA   |



| Table 3<br>Summary of Airborne Contaminant Concentrations*<br>Bureau of Alcohol, Tobacco, and Firearms, Washington, D.C. (HETA 96-0171) |                           |                        |               |               |                                    |                                      |                                 |                                     |                                  |                    |                |                |
|---|---------------------------|------------------------|---------------|---------------|------------------------------------|--------------------------------------|---------------------------------|-------------------------------------|----------------------------------|--------------------|----------------|----------------|
| Sample description  | Sample duration (minutes) | Hydrogen cyanide (ppm) | Benzene (ppm) | Toluene (ppm) | Sulfuric Acid (mg/m <sup>3</sup> ) | Respirable dust (mg/m <sup>3</sup> ) | Total dust (mg/m <sup>3</sup> ) | Formaldehyde Impinger samples (ppm) | Formaldehyde sorbent tubes (ppm) | Acetaldehyde (ppm) | Acrolein (ppm) | Furfural (ppm) |
| <b>Area samples collected during each scenario</b>  |                           |                        |               |               |                                    |                                      |                                 |                                     |                                  |                    |                |                |
| Nelson Place fire scene   | 47                        | ND                     | —             | —             | trace                              | ND                                   | 0.20                            | —                                   | ND                               | ND                 | ND             | —              |
| Lamont Drive fire scene   | 182                       | 0.01                   | —             | —             | —                                  | 0.10                                 | 0.33                            | —                                   | trace                            | 0.13               | 0.02           | —              |
| Living room scenario  | 49 (60)                   | 0.04                   | trace         | trace         | trace                              | 0.36                                 | 0.92                            | 0.06 <sup>^</sup>                   | ND                               | trace              | ND             | ND             |
| Bedroom scenario  | 50                        | trace                  | trace         | trace         | trace†                             | 0.35                                 | 1.1                             | 0.16                                | trace                            | trace              | ND             | ND             |
| Office scenario   | 38 (34)                   | trace                  | trace         | trace         | trace                              | 1.2                                  | 5.3                             | 0.18                                | ND                               | trace              | ND             | trace          |
| <b>Personal breathing zone samples collected on investigators</b>   |                           |                        |               |               |                                    |                                      |                                 |                                     |                                  |                    |                |                |
| Living room scenario  | 55                        | —                      | —             | —             | —                                  | —                                    | —                               | —                                   | ND                               | trace              | ND             | ND             |
| Living room scenario  | 55                        | —                      | —             | —             | 0.29                               | —                                    | —                               | —                                   | —                                | —                  | —              | —              |
| Living room scenario  | 56                        | trace                  | —             | —             | —                                  | —                                    | —                               | —                                   | —                                | —                  | —              | —              |
| Bedroom scenario  | 62                        | —                      | —             | —             | —                                  | —                                    | —                               | —                                   | trace                            | trace              | ND             | trace          |
| Bedroom scenario  | 62                        | 0.03                   | —             | —             | trace†                             | —                                    | —                               | —                                   | —                                | —                  | —              | —              |
| Office scenario   | 40                        | —                      | —             | —             | trace†                             | —                                    | —                               | —                                   | ND                               | trace              | ND             | trace          |
| Office scenario   | 40                        | trace                  | trace         | trace         | —                                  | —                                    | —                               | —                                   | —                                | —                  | —              | —              |

\*Analyses for vylene and styrene were also conducted; however, neither compound was detected. The minimum detectable concentrations (MDC) for vylene and styrene were 0.03 and 0.13 ppm, respectively, assuming a sample volume of 8.8 liters.

— Analysis for this particular contaminant was not performed on sample described.

() - Sample duration for impingers, if different than other samples.

trace - detected value was between the MDC and minimum quantifiable concentration (MQC), respectively; assuming a sampling volume as noted: hydrogen cyanide 0.01-0.03 ppm (9.8 liters); benzene 0.04-0.12 ppm (8.8 liters); toluene 0.03-0.10 ppm (8.8 liters); sulfuric acid 0.08-0.27 mg/m<sup>3</sup> (12.4 liters); formaldehyde 0.13-0.43 ppm (4.9 liters); acetaldehyde 0.05-0.14 ppm (4.9 liters); furfural 0.04-0.13 ppm (4.9 liters).

<sup>^</sup> Average of two samples collected during this scenario (0.05 and 0.06 ppm).

ND - not detected; below the analytical limit of detection.

† trace concentrations of hydrochloric acid (0.07-0.29 ppm) or hydrofluoric acid (0.12-0.50 ppm) were detected on these samples collected during the office or bedroom scenarios, respectively.

| Table 4<br>Summary of Airborne Particle Size Distributions and Dust Concentrations Determined Using the Grimm Portable Dust Monitor<br>Bureau of Alcohol, Tobacco, and Firearms, Washington, D.C. (HETA 96-0171) |  |   |                   |  |  |                              |
|--|--|---|-------------------|--|--|------------------------------|
| Sample description   | Concentration Determined by Grimm (mg/m <sup>3</sup> ) | Actual Concentration Determined Gravimetrically* (mg/m <sup>3</sup> ) | Correction Factor | Peak Concentration Measured by Grimm† (mg/m <sup>3</sup> ) | Mass Median Aerodynamic Diameter (micrometers) | Geometric Standard Deviation |
| Nelson Place fire scene  | 0.7  | 0.5   | 0.68              | 6.4  | 9.8  | 2.1                          |
| Lamont Drive fire scene  | 0.8  | 0.2   | 0.31              | 11.2   | 6.3  | 2.2                          |
| Living room scenario   | 1.1  | 1.0   | 0.87              | 3.5  | 6.1  | 3.1                          |
| Bedroom scenario   | 1.8  | 1.0   | 0.56              | 5.1  | 10.4   | 3.1                          |
| Office scenario  | 11.7   | 8.7   | 0.74              | 31.6   | 11.7   | 2.5                          |

\* This concentration was calculated by obtaining the difference between the pre- and post-sampling weights of the 47 millimeter, teflon filter used in the Grimm portable dust monitor. This weight difference was then divided by the sample air volume to obtain the actual concentration. The sample volume was calculated using a flow rate of 1.2 liters per minute.

† Peak concentrations were mass corrected by multiplying the peak concentration measured with the Grimm and the listed correction factor.

mg/m<sup>3</sup> - milligrams per cubic meter of air

| Table 5<br>Summary of Airborne PAH Concentrations (µg/m <sup>3</sup> )<br>Bureau of Alcohol, Tobacco, and Firearms, Washington, D.C. (HETA 96-0171) |                           |             |          |              |                |              |            |               |        |                    |                      |                      |                |                        |                       |                      |
|---|---------------------------|-------------|----------|--------------|----------------|--------------|------------|---------------|--------|--------------------|----------------------|----------------------|----------------|------------------------|-----------------------|----------------------|
| Sample Description  | Sample Duration (minutes) | Naphthalene | Fluorane | Phenanthrene | Acenaphthylene | Acenaphthene | Anthracene | Fluoranthrene | Pyrene | Benzo(a)anthracene | Benzo(b)fluoranthene | Benzo(k)fluoranthene | Benzo(a)pyrene | Indeno(1,2,3-cd)pyrene | Dibenz(a,h)anthracene | Benzo(g,h,i)perylene |
| <b>Residential Fire Scenes (2/12-13/97)</b>   |                           |             |          |              |                |              |            |               |        |                    |                      |                      |                |                        |                       |                      |
| Nelson Place fire scene   | 47                        | 30          | trace    | trace        | ND             | ND           | ND         | ND            | ND     | ND                 | ND                   | ND                   | ND             | ND                     | ND                    | ND                   |
| Lamont Drive fire scene   | 182                       | 36          | 2.4      | trace        | ND             | ND           | ND         | ND            | ND     | ND                 | ND                   | ND                   | ND             | ND                     | ND                    | ND                   |
| Minimum Detectable Concentration  |                           | 3.1         | 0.4      | 0.1          | 8.7            | 2.6          | 0.22       | 0.44          | 0.35   | 0.22               | 0.44                 | 0.17                 | 0.35           | 0.44                   | 0.87                  | 1.3                  |
| Minimum Quantifiable Concentration  |                           | 10          | 1.4      | 0.4          | 29             | 8.7          | 0.70       | 1.4           | 1.1    | 0.70               | 1.4                  | 0.57                 | 1.1            | 1.4                    | 2.9                   | 4.3                  |
| <b>Ft. Belvoir Staged Fire Scenes (6/3/97)</b>  |                           |             |          |              |                |              |            |               |        |                    |                      |                      |                |                        |                       |                      |
| Living room scenario  | 49                        | 99          | 7.4      | 3.5          | 44             | 12           | 0.65       | 0.66          | 0.31   | 0.14               | trace                | 0.06                 | 0.16           | ND                     | trace                 | trace                |
| Bedroom scenario  | 50                        | 200         | 18       | 6.3          | 100            | 65           | 0.30       | 0.44          | 0.29   | 0.09               | trace                | trace                | 0.11           | ND                     | trace                 | trace                |
| Office scenario   | 38                        | 132         | 11       | 8.0          | 66             | 20           | 1.6        | 1.1           | 0.74   | 0.29               | 0.21                 | 0.12                 | 0.39           | trace                  | trace                 | 0.25                 |
| Minimum Detectable Concentration  |                           | 4.4         | 0.9      | 0.7          | 8.8            | 3.3          | 0.01       | 0.02          | 0.01   | 0.01               | 0.03                 | 0.02                 | 0.02           | 0.11                   | 0.04                  | 0.03                 |
| Minimum Quantifiable Concentration  |                           | 16          | 2.9      | 2.1          | 31             | 12           | 0.03       | 0.07          | 0.04   | 0.05               | 0.12                 | 0.06                 | 0.06           | 0.35                   | 0.15                  | 0.12                 |

µg/m<sup>3</sup> – micrograms per cubic meter of air

trace – detected value was between the minimum detectable concentration (MDC) and minimum quantifiable concentration (MQC). These values are listed above and were calculated assuming a sampling volume of 229 liters for the residential fire scenes and 91 liters for the Ft. Belvoir staged fire scenes. The MDCs and MQCs are presented separately because the analytical limits of detection and quantitation differed significantly for the two sets of analyses.

ND – not detected; below the analytical limit of detection and corresponding MDC.

| Table 6<br>Summary of Analytical Limits of Detection and Quantitation with Corresponding<br>Minimum Detectable and Quantifiable Concentrations<br>Bureau of Alcohol, Tobacco, and Firearms, Washington, D.C. (HETA 96-0171) |  |  |                                    |                                    |                                  |
|---|--|--|------------------------------------|------------------------------------|----------------------------------|
| Analyte   | LOD<br>( $\mu\text{g}/\text{sample}$ ) | LOQ<br>( $\mu\text{g}/\text{sample}$ ) | MDC<br>( $\text{ppm}^{\text{a}}$ ) | MQC<br>( $\text{ppm}^{\text{a}}$ ) | Sample Air<br>Volume<br>(liters) |
| Formaldehyde (Fire Scenes #1 & 2)   | 0.3                                    | 1.0                                    | 0.01                               | 0.04                               | 18.2                             |
| Formaldehyde (Fire Scenes #3, 4, & 5)   | 0.8                                    | 2.6                                    | 0.13                               | 0.43                               | 4.9                              |
| Acetaldehyde (Fire Scenes #1 & 2)   | 0.9                                    | 3.0                                    | 0.03                               | 0.09                               | 18.2                             |
| Acetaldehyde (Fire Scenes #3, 4, & 5)   | 0.4                                    | 1.2                                    | 0.05                               | 0.14                               | 4.9                              |
| Acrolein (Fire Scenes #1 & 2)   | 0.3                                    | 1.0                                    | 0.01                               | 0.02                               | 18.2                             |
| Acrolein (Fire Scenes #3, 4, & 5)   | 1.0                                    | 4.5                                    | 0.09                               | 0.40                               | 4.9                              |
| Furfural (Fire Scenes #3, 4, & 5)   | 0.8                                    | 2.6                                    | 0.04                               | 0.13                               | 4.9                              |
| Hydrogen Cyanide (Fire Scenes #1 & 2)   | 0.1                                    | 0.35                                   | 0.002                              | 0.009                              | 36.4                             |
| Hydrogen Cyanide (Fire Scenes #3, 4, & 5)   | 0.1                                    | 0.35                                   | 0.01                               | 0.03                               | 9.8                              |
| Sulfuric Acid (Fire Scenes #1 & 2)  | 2.0                                    | 6.7                                    | 0.05 $\text{mg}/\text{m}^3$        | 0.18 $\text{mg}/\text{m}^3$        | 36.4                             |
| Sulfuric Acid (Fire Scenes #3, 4, & 5)  | 1.0                                    | 3.4                                    | 0.10 $\text{mg}/\text{m}^3$        | 0.35 $\text{mg}/\text{m}^3$        | 9.8                              |
| Nitric Acid (Fire Scenes #1 & 2)  | 2.0                                    | 6.7                                    | 0.02                               | 0.07                               | 36.4                             |
| Hydrochloric Acid (Fire Scenes #3, 4, & 5)  | 1.0                                    | 4.2                                    | 0.07                               | 0.29                               | 9.8                              |
| Hydrofluoric Acid (Fire Scenes #3, 4, & 5)  | 1.0                                    | 4.0                                    | 0.12                               | 0.50                               | 9.8                              |
| Benzene (Fire Scenes #3, 4, & 5)  | 0.001                                  | 0.033                                  | 0.04                               | 0.12                               | 8.8                              |
| Toluene (Fire Scenes #3, 4, & 5)  | 0.001                                  | 0.033                                  | 0.03                               | 0.10                               | 8.8                              |

\*Unless otherwise noted.

**LOD** – Limit of Detection  
 $\mu\text{g}/\text{sample}$  – micrograms per sample  
**LOQ** – Limit of Quantitation  
**MDC** – Minimum Detectable Concentration  
 $\text{ppm}$  – parts per million  
**MQC** – Minimum Quantifiable Concentration  
 $\text{mg}/\text{m}^3$  – milligrams per cubic meter of air

**APPENDIX A-12: TABLES AND FIGURES FROM [TREITMAN 1980]**

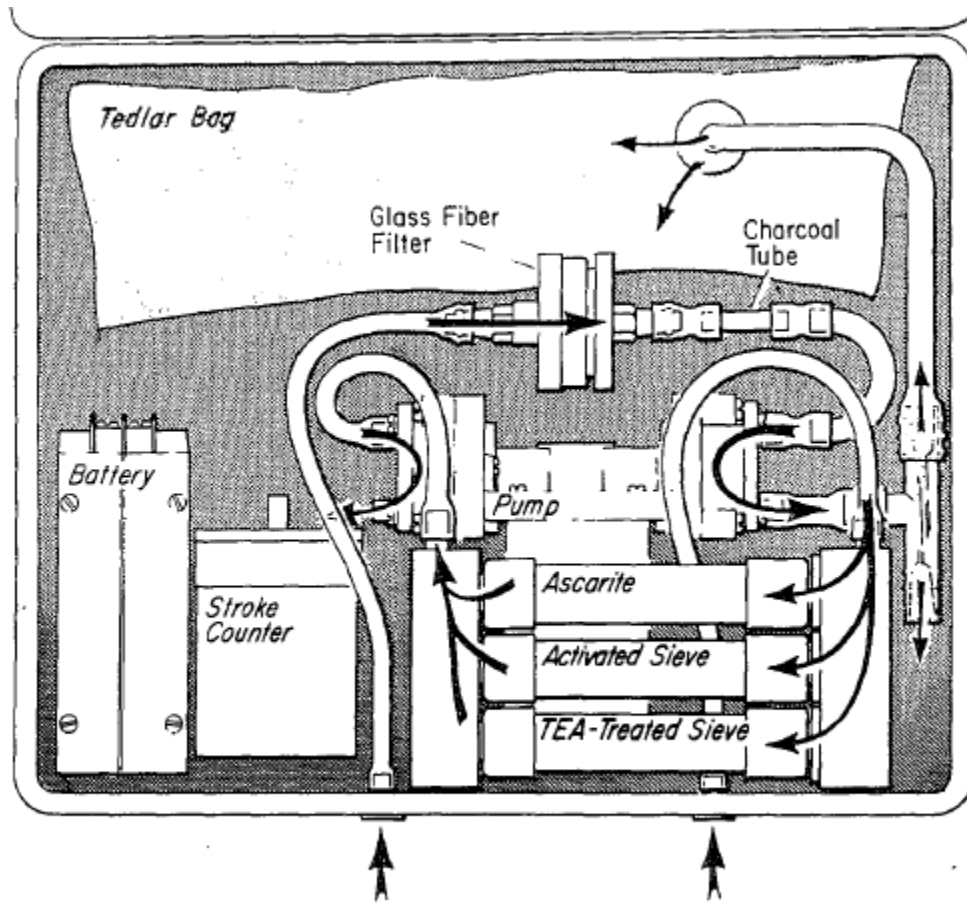


Figure 1 — Principal components of air sampler.



**TABLE I**  
**Sampling and Analytical Procedures**

| Contaminant                    | Collection Medium                               | Analytical Technique   |
|--------------------------------|---|--|
| Carbon monoxide                | Tedlar bag                                      | Ecolyzer   |
| Carbon dioxide                 | Tedlar bag                                      | Detector tube  |
| Nitrogen dioxide               | Triethanolamine-treated<br>13X molecular sieves | Saltzman reaction, colorimetric:<br>NO <sub>2</sub> initiated diazo coupling<br>between sulfanilamide and N-(1<br>naphthyl) ethylenediamine to<br>form chromophore with $\lambda_{max} =$<br>540 nm.   |
| Hydrogen chloride              | Triethanolamine-treated<br>13X molecular sieves | Zall, colorimetric: displacement<br>of (SCN) <sup>-</sup> from Hg (SNC) <sub>2</sub> by C1 <sup>-</sup> in<br>the presence of excess Fe <sup>+3</sup> to<br>form chromophore Fe (SCN) <sup>+2</sup><br>with $\lambda_{max} = 460$ nm.                                    |
| Hydrogen cyanide               | Ascarite  | Colorimetric: treatment of neu-<br>tralized solution of N-chlorosuc-<br>cinimide to oxidize HCN to CNC1<br>followed by oxidation of pyridine<br>by CNC1 to a dialdehyde which<br>couples with barbituric acid to<br>form a chromophore with $\lambda_{max} =$<br>550 nm. |
| Acrolein                       | Activated 13X molecular<br>sieves               | Gas chromatographic: desorption<br>of sieves with distilled water<br>followed by analysis of formalde-<br>hyde with chromotropic acid and<br>remaining compounds by g.c. on<br>Tenax GC.   |
| Aromatics<br>(Benzene)         | Activated charcoal                              | Gas chromatographic: desorption<br>of charcoal with CS <sub>2</sub> (carbon di-<br>sulfide) followed by g.c. analysis<br>on SE 30 column.  |
| Total suspended<br>particulate | Fiberglass filter                               | Gravimetric  |

**TABLE II**  
**Exposure Indices for Air Contaminants**

| Contaminant       | ACGIH - STEL<br>(15 mins.) | IDLH<br>(30 mins.) | STLC<br>(10 mins.) |
|-------------------|----------------------------|--------------------|--------------------|
| Nitrogen dioxide  | 5 ppm                      | 50 ppm             | >200 ppm           |
| Hydrogen chloride | 5 <sup>A</sup>             | 100                | >500 <sup>B</sup>  |
| Hydrogen cyanide  | 15                         | 50                 | 350                |
| Acrolein          | 0.3                        | 5                  | 30-100             |
| Carbon monoxide   | 400                        | 1 500              | 5 000              |
| Carbon dioxide    | 15 000                     | 50 000             | 100 000            |
| Benzene           | -                          | 2 000              | 20 000             |

<sup>A</sup>Ceiling value

<sup>B</sup>In the absence of particulates

**APPENDIX A-13: TABLES FROM [LEONARD 2007]**

Table 1  
Particle mass-based size distribution

| Filter number | Mean diameter ( $\mu\text{m}$ ) | Mass concentration (% of total) |
|---------------|---------------------------------|---------------------------------|
| 1             | 24                              | 6.3                             |
| 2             | 13.4                            | 7                               |
| 3             | 7.4                             | 8.3                             |
| 4             | 4.2                             | 14.5                            |
| 5             | 2.4                             | 11.3                            |
| 6             | 1.34                            | 13                              |
| 7             | 0.74                            | 10                              |
| 8             | 0.42                            | 9.5                             |
| 9             | 0.24                            | 7.8                             |
| 10            | 0.134                           | 5.7                             |
| 11            | 0.074                           | 3.7                             |
| 12            | 0.042                           | 3                               |

**APPENDIX A-14: TABLES FROM [LEMASTERS 2006]**

| Reference                   | Company Location                | Design/Analysis                            | Study Period                  | Number of Workers                   | Comparison Group         | Exposure Variable | Exposure Source | Cancer Source | Co-factors         |
|-----------------------------|---------------------------------|--|-------------------------------|-------------------------------------|--------------------------|-------------------|-----------------|---------------|--------------------|
| Barfi, 2001 <sup>13</sup>   | Philadelphia                    | Co hort mortality (SMR)                    | 1925-1986                     | 7789                                | INT/NGP/NED              | 1, 3, 5           | ER              | DC            | Age                |
| Ma, 1998 <sup>14</sup>      | 24 US states                    | Case-control (MOR)                         | 1984-1993                     | 6907                                | INT                      | 4                 | DC              | DC            | Age/race           |
| Figgis, 1995 <sup>15</sup>  | 24 US states                    | Case-control (MOR)                         | 1984-1989                     | 23890 (cases)<br>119,450 (controls) | RGP                      | 4                 | DC              | DC            | Age                |
| Burnett, 1994 <sup>16</sup> | 27 US states                    | PMR  | 1984-1990                     | 5744                                | INT                      | 4                 | DC              | DC            | Age                |
| Demeis, 1993 <sup>17</sup>  | 4 US states                     | Case-control (CR)                          | 1977-1981                     | 692 (cases)<br>1683 (controls)      | LGP                      | 4                 | TRV             | TRV           | Age                |
| Demeis, 1992a <sup>18</sup> | Seattle, Tacoma (WA)            | Co hort mortality (SMR)                    | 1944-1979                     | 4528                                | LGP                      | 4                 | ER              | DCIN, TRV     | Age                |
| Demeis, 1992b <sup>18</sup> | Seattle, Tacoma, WA<br>Portland | Incidence (SIR)<br>Co hort mortality (SMR) | 1944-1979                     | 4546                                | INT/LW/NGP<br>INT/LW/NGP | 2, 3              | ER              | DCIN          | Age                |
| Baumont, 1991 <sup>20</sup> | San Francisco                   | Co hort mortality (RR)                     | 1940-1970                     | 3066                                | NGP                      | 3, 6              | ER              | DCIN          | Age/yr             |
| Grimes, 1991 <sup>21</sup>  | Honolulu                        | PMR, RR                                    | 1969-1988                     | 205                                 | RGP                      | 3, 4              | ER              | DC            | Race               |
| Sama, 1990 <sup>22</sup>    | Massachusetts                   | Case-control (MOR)                         | 1982-1986                     | 315                                 | LW/RGP                   | 4, 7              | TRV             | TR            | Age/smoke          |
| Vena, 1987 <sup>23</sup>    | Buffalo                         | Co hort mortality (SMR)                    | 1950-1979                     | 1867                                | NGP                      | 3                 | ER              | DCIN          | Age/yr             |
| Feuer, 1995 <sup>24</sup>   | New Jersey                      | PMR  | 1974-1980                     | 263                                 | LW/RGP/NGP               | 3, 8              | ER              | DCIN          | Age                |
| Morton, 1984 <sup>25</sup>  | Portland, Vancouver             | Incidence (SIR)                            | 1963-1977                     | 1678                                | RGP                      | 4                 | TR              | TRV           | Age                |
| Dubrow, 1993 <sup>26</sup>  | British & USA                   | Co hort mortality (SMR)                    | 1950-1977                     | —                                   | —                        | 4                 | AR              | DC            | None               |
| Musk, 1978 <sup>27</sup>    | US                              | Co hort mortality (SMR)                    | 1915-1975                     | 5655                                | RGP, NGP                 | 4                 | ER              | DC            | Age                |
| Berg 1975 <sup>28</sup>     | US, Great Britain               | Co hort mortality (SMR)                    | 1949-1953<br>and<br>1959-1963 | —                                   | NGP                      | 4                 | DC              | DC            | Age                |
| Stang, 2003 <sup>29</sup>   | Germany                         | PMR<br>Case-control (CR)                   | 1959-1963<br>1995-1997        | 269 (cases)<br>797 (controls)       | RGP                      | 4                 | ER              | MR            | Age                |
| Bates, 2001 <sup>30</sup>   | New Zealand                     | Co hort mortality (SMR)                    | 1977-1995                     | 4221                                | NGP                      | 3                 | AR              | DC, TR        | Age/yr             |
| Firth, 1996 <sup>31</sup>   | New Zealand                     | Incidence (SIR)                            | 1972-1984                     | 26207                               | NED                      | 4                 | TR              | TR            | Age                |
| Dechamps 1995 <sup>32</sup> | France                          | Co hort mortality (SMR)                    | 1977-1991                     | 830                                 | NGP                      | 2                 | ER              | DCIN          | Age                |
| Deihunt, 1995 <sup>33</sup> | New Zealand                     | Case-control (RR)                          | 1978-1986                     | 710 (cases)<br>12,756 (controls)    | NGP                      | 4                 | TR              | TR            | Age/smoke          |
| Aronson, 1994 <sup>34</sup> | Canada                          | Co hort mortality (SMR)                    | 1950-1989                     | 5414                                | RGP                      | 3, 6, 7           | ER              | DCIN          | Age/yr             |
| Tomling, 1994 <sup>35</sup> | Sweden                          | Co hort mortality (SMR)                    | 1931-1983                     | 1153                                | LGP                      | 1, 3, 7           | ER              | DC, TR        | Age/yr             |
| Gilks, 1993 <sup>36</sup>   | Australia                       | Incidence (SIR)                            | 1980-1989                     | 2865                                | RGP                      | 3, 6, 7           | TRV             | TR            | Age                |
| Guldott, 1993 <sup>37</sup> | Canada                          | Co hort mortality (SMR)                    | 1927-1987                     | 3328                                | RGP                      | 2                 | ER              | DCIN          | Age/yr             |
| Hansen, 1990 <sup>38</sup>  | Denmark                         | Co hort mortality (SMR)                    | 1970-1980                     | 886                                 | NED                      | 4                 | OTH             | DC            | Age<br>(Continued) |

**TABLE 1**  
Continued

| Reference   | Company Location | Design/Analysis               | Study Period | Number of Workers | Comparison Group | Exposure Variable | Exposure Source | Cancer Source | Cofactors |
|---|------------------|-------------------------------|--------------|-------------------|------------------|-------------------|-----------------|---------------|-----------|
| Eliopoulos, 1984 <sup>29</sup>  | Australia        | Cohort mortality (SMR)<br>PMR | 1939-1978    | 990               | RGP              | 3                 | ER              | DC            | Age/yr    |
| Mastromatteo, 1959 <sup>40</sup>  | Canada           | Cohort mortality (SMR)        | 1921-1953    | 1039              | RGP              | 4                 | DC              | DC            | Age       |
| <p><u>Exposure Variables</u></p> <ol style="list-style-type: none"> <li>1. Number of firefighter runs</li> <li>2. Duration of "active" duty</li> <li>3. Duration of employment overall as a firefighter</li> <li>4. Occupation (based on death certificate or tumor registry)</li> <li>5. Company type engine, ladder</li> <li>6. Time since first employment</li> <li>7. Age-specific</li> <li>8. Employment status</li> </ol> |                  |                               |              |                   |                  |                   |                 |               |           |
| <p><u>Exposure or Cancer Source</u></p> <p>ER, employment records<br/>MR, medical records<br/>AR, association records<br/>DC, death certificate<br/>DON, death certificate nosologist<br/>TR, tumor registry with no validation<br/>TRV, tumor registry (occupation) with validation from external sources<br/>OTH, other</p>   |                  |                               |              |                   |                  |                   |                 |               |           |
| <p><u>Design/Analysis</u></p> <p>RR, rate ratio<br/>SMR, standardized mortality/morbidity ratio<br/>MOR, mortality odds ratio<br/>OR, odds ratio<br/>PMR, proportional mortality ratio<br/>SIR, standardized incidence mortality</p>  |                  |                               |              |                   |                  |                   |                 |               |           |
| <p><u>Comparison Group</u></p> <p>INT = internal<br/>LW = local workers<br/>LGP = local general population<br/>RGP = regional general population<br/>NGP = national general population<br/>NED = national employment database</p>   |                  |                               |              |                   |                  |                   |                 |               |           |

**TABLE 2**  
Metarelative Risk Estimates and Test for Inconsistency for Mortality and Incidence\*

| Disease                                   | Number of Studies | Reference                                 | Observed | Expected | Metarelative Risk | 95% Confidence Interval | P Value Inconsistency |
|---|-------------------|---|----------|----------|-------------------|-------------------------|-----------------------|
| <b>Mortality studies</b>                  |                   |   |          |          |                   |                         |                       |
| <b>Standardized mortality ratio (SMR)</b> |                   |   |          |          |                   |                         |                       |
| All causes (001-999)                      | 12                | 13, 19, 23, 27, 30, 32, 34, 35, 37-40     | 8384     | 9273.8   | 0.90              | 0.85-0.97               | <0.00                 |
| All cancers (140-209)                     | 13                | 13, 19, 23, 27, 30, 32, 34, 35, 37-40, 51 | 1801     | 1799.9   | 1.00              | 0.93-1.08               | 0.02                  |
| Buccal cavity and pharynx (140-149)       | 5                 | 13, 19, 32, 34, 37                        | 34       | 29.8     | 1.14              | 0.79-1.60               | 0.84                  |
| Esophagus (150)                           | 4                 | 13, 19, 23, 34                            | 17       | 25.1     | 0.68              | 0.39-1.08               | 0.62                  |
| Stomach (151)                             | 7                 | 13, 19, 23, 30, 34, 35, 37                | 75       | 81.3     | 0.92              | 0.73-1.16               | 0.72                  |
| Colon (153)                               | 10                | 13, 19, 23, 26, 28, 30, 34, 35, 37, 51    | 252      | 188.3    | 1.34              | 1.01-1.79               | <0.00                 |
| Rectum (154)                              | 6                 | 13, 19, 23, 30, 34, 35                    | 54       | 40.7     | 1.33              | 1.00-1.73               | 0.43                  |
| Liver/gallbladder (155-156)               | 5                 | 13, 19, 23, 34, 35                        | 22       | 21.9     | 1.00              | 0.63-1.52               | 0.92                  |
| Pancreas (157)                            | 6                 | 13, 19, 23, 34, 35, 37                    | 63       | 64.2     | 0.98              | 0.75-1.26               | 0.58                  |
| Larynx (161)                              | 3                 | 13, 19, 34                                | 8        | 13.7     | 0.58              | 0.25-1.15               | 0.82                  |
| Lung (162)                                | 8                 | 13, 19, 30, 34, 35, 37, 38, 51            | 378      | 359.2    | 1.06              | 0.95-1.16               | 0.50                  |
| Skin (173)                                | 3                 | 13, 19, 37                                | 16       | 15.7     | 1.02              | 0.58-1.66               | 0.68                  |
| Malignant melanoma (172)                  | 2                 | 30, 34                                    | 4        | 5.9      | 0.67              | 0.18-1.70               | 0.23                  |
| Prostate (185)                            | 6                 | 13, 19, 23, 34, 35, 37                    | 104      | 91       | 1.14              | 0.93-1.39               | 0.67                  |
| Testis (186)                              | 1                 | 34  | 3        | 1.2      | 2.50              | 0.50-7.30               | —                     |
| Bladder (188)                             | 6                 | 13, 19, 23, 30, 34, 37                    | 41       | 33.0     | 1.24              | 0.68-2.26               | 0.03                  |
| Kidney (189)                              | 6                 | 13, 19, 23, 34, 35, 37                    | 30       | 30.9     | 0.97              | 0.44-2.13               | 0.01                  |
| Brain and nervous system (191-192)        | 8                 | 13, 19, 23, 27, 30, 34, 35, 37            | 64       | 46.1     | 1.39              | 0.94-2.06               | 0.07                  |
| Non-Hodgkin's lymphoma (200, 202)         | 3                 | 13, 19, 34                                | 30       | 20.6     | 1.46              | 0.98-2.08               | 0.92                  |
| Hodgkin's disease (201)                   | 2                 | 19, 34                                    | 4        | 5.1      | 0.78              | 0.21-2.01               | 0.59                  |
| Multiple myeloma (203)                    | 4                 | 13, 26, 34, 51                            | 24       | 14.2     | 1.69              | 1.08-2.51               | 0.15                  |
| Leukemia (204-208)                        | 2                 | 13, 19                                    | 30       | 29.9     | 1.00              | 0.66-1.43               | 0.27                  |
| <b>Proportional mortality ratio (PMR)</b> |                   |   |          |          |                   |                         |                       |
| All cancers (140-209)                     | 6                 | 16, 24, 39, 48, 49, 50                    | 2443     | 2215.7   | 1.10              | 1.06-1.15               | 0.84                  |
| Buccal cavity and pharynx (140-149)       | —                 | —   | —        | —        | —                 | —                       | —                     |
| Esophagus (150)                           | —                 | —   | —        | —        | —                 | —                       | —                     |
| Stomach (151)                             | —                 | —   | —        | —        | —                 | —                       | —                     |
| Colon (153)                               | 4                 | 28, 48, 49, 50                            | 99       | 79.2     | 1.25              | 0.90-1.74               | 0.08                  |
| Rectum (154)                              | 1                 | 16  | 37       | 25       | 1.48              | 1.05-2.05               | —                     |
| Liver/gallbladder (155-156)               | —                 | —   | —        | —        | —                 | —                       | —                     |
| Pancreas (157)                            | —                 | —   | —        | —        | —                 | —                       | —                     |
| Larynx (161)                              | —                 | —   | —        | —        | —                 | —                       | —                     |
| Lung (162)                                | 4                 | 16, 48, 49, 50                            | 773      | 742.1    | 1.04              | 0.88-1.23               | 0.04                  |
| Skin (172-173)                            | 2                 | 16, 24                                    | 42       | 24.8     | 1.69              | 1.22-2.29               | 0.41                  |
| Malignant melanoma (172)                  | 2                 | 48, 49                                    | 9        | 4        | 2.25              | 1.03-4.27               | 0.49                  |
| Prostate (185)                            | —                 | —   | —        | —        | —                 | —                       | —                     |

(Continued)

TABLE 2  
Continued

| Disease                            | Number of Studies | Reference      | Observed | Expected | Metarelative Risk | 95% Confidence Interval | P Value Inconsistency |
|------------------------------------|-------------------|----------------|----------|----------|-------------------|-------------------------|-----------------------|
| Testis (186)                       | 2                 | 30, 36         | 21       | 11.5     | 1.83              | 1.13-2.79               | 0.15                  |
| Bladder (188)                      | 2                 | 18, 30         | 31       | 29.9     | 1.04              | 0.70-1.47               | 0.87                  |
| Kidney (189)                       | 3                 | 18, 30, 35     | 11       | 18       | 0.81              | 0.30-1.09               | 0.89                  |
| Brain and nervous system (191-192) | 3                 | 18, 30, 35     | 19       | 15.4     | 1.23              | 0.74-1.93               | 0.84                  |
| Non-Hodgkin's lymphoma (200-202)   | 1                 | 36             | 4        | 2.2      | 1.82              | 0.49-4.05               | —                     |
| Hodgkin's disease (201)            | —                 | —              | —        | —        | —                 | —                       | —                     |
| Multiple myeloma (203)             | —                 | —              | —        | —        | —                 | —                       | —                     |
| Leukemia (204-206)                 | 4                 | 18, 25, 30, 36 | 18       | 12.9     | 1.4               | 0.82-2.21               | 0.36                  |

Note. Codes of the International Classification of Causes of Death (9th Revision) in parentheses; published data for references 48-50 in Howe and Birch.<sup>4</sup>

\*Meta analysis completed only for two or more studies.

†Reference 36 is a combination of colon and rectum cancers.

TABLE 3  
Mortality and Incidence Studies for Case-Control/Mortality Odds Ratio Studies

|                                     | Outcome   | References | Odds Ratio | 95% Confidence Interval |
|-------------------------------------|-----------|------------|------------|-------------------------|
| All cancers (140-209)               | Mortality | 14         | 1.10       | 1.10-1.20               |
| Buccal cavity and pharynx (140-149) | Mortality | 14         | 5.90       | 1.90-18.30              |
| Esophagus (150)                     | Mortality | 14         | 0.90       | 0.70-1.30               |
| Stomach (151)                       | Mortality | 14         | 1.20       | 0.90-1.60               |
| Colon (153)                         | Mortality | 14         | 1.00       | 0.90-1.20               |
|                                     | Incidence | 22*        | 1.04       | 0.59-1.82               |
| Rectum (154)                        | Mortality | 14         | 1.10       | 0.80-1.60               |
|                                     | Incidence | 22*        | 0.97       | 0.50-1.88               |
| Liver/gallbladder (155-156)         | Mortality | 14         | 1.20       | 0.90-1.70               |
| Pancreas (157)                      | Mortality | 14         | 1.20       | 1.00-1.50               |
|                                     | Incidence | 22*        | 3.19       | 0.72-14.15              |
| Larynx (161)                        | Mortality | 14         | 0.80       | 0.40-1.30               |
| Lung (162)                          | Mortality | 14         | 1.10       | 1.00-1.20               |
|                                     | Incidence | 22*        | 1.30       | 0.84-2.03               |
| Skin (172-173)                      | Mortality | 14         | 1.00       | 0.50-1.90               |
| Malignant melanoma (172)            | Mortality | 14         | 1.40       | 1.00-1.90               |
|                                     | Incidence | 22*        | 1.38       | 0.80-3.19               |
| Prostate (185)                      | Mortality | 14         | 1.20       | 1.00-1.30               |
| Testis (186)                        | Incidence | 29         | 4.00       | 0.70-27.40              |
| Bladder (188)                       | Mortality | 14         | 1.20       | 0.90-1.60               |
|                                     | Incidence | 22*        | 2.11       | 1.07-4.14               |
| Kidney (189)                        | Mortality | 14         | 1.30       | 1.00-1.70               |
|                                     | Incidence | 33         | 4.89       | 2.47-8.93               |
| Brain and nervous system (191-192)  | Mortality | 14         | 1.00       | 0.80-1.40               |
|                                     | Incidence | 22*        | 1.52       | 0.39-5.92               |
| Non-Hodgkin's lymphoma (200, 202)   | Mortality | 14, 15†    | 1.41       | 1.10-1.70               |
|                                     | Incidence | 22*        | 3.27       | 1.19-8.98               |
| Hodgkin's disease (201)             | Mortality | 14         | 2.40       | 1.40-4.10               |
| Multiple myeloma (203)              | Mortality | 14         | 1.10       | 0.80-1.60               |
|                                     | Incidence | 17         | 1.90       | 0.50-9.40               |
| Leukemia (204-206)                  | Mortality | 14         | 1.10       | 0.80-1.40               |
|                                     | Incidence | 22*        | 2.87       | 0.62-11.54              |

\*Two control groups available; police rather than state employees selected as most comparable. Significance difference only for malignant melanoma when using state employees odds ratio and 95% confidence interval was 2.92 (1.70-5.03).

†Mortality odds ratio (mOR) calculated only for non-Hodgkin lymphoma as only case-control study with at least two studies. mOR estimated based primarily on larger sample in Ma et al.<sup>14</sup>

**TABLE 5**  
Summary of Likelihood of Cancer Risk and Summary Risk Estimate (95% CI) Across All Types of Studies for All Cancers

| Cancer Site               | Likelihood of Cancer Risk by Criteria | Summary Risk Estimate (95% CI) | Comments   |
|---------------------------|---------------------------------------|--------------------------------|--|
| Multiple myeloma          | Probable                              | 1.53 (1.21–1.94)               | Consistent with mSMR and PMR (1.50, 95% CI = 1.17–1.89)<br>Based on 10 analyses<br>Heterogeneity—not significant at the 10% level  |
| Non-Hodgkin lymphoma      | Probable                              | 1.51 (1.31–1.73)               | Only two SMR and another PMR studies<br>Slightly higher than mSMR and PMR (1.36, 95% CI = 1.10–1.67)<br>Based on eight analyses<br>Heterogeneity—not significant at the 10% level    |
| Prostate                  | Probable                              | 1.28 (1.15–1.43)               | Consistent with mSIR (1.29, 95% CI = 1.09–1.51)<br>Based on 13 analyses<br>Heterogeneity—not significant at the 10% level  |
| Testis                    | Possible                              | 2.02 (1.30–3.13)               | Slightly higher than mSIR (1.83, 95% CI = 1.13–2.79)<br>Based on four analyses<br>Heterogeneity—not significant at the 10% level   |
| Skin                      | Possible                              | 1.39 (1.10–1.73)               | Slightly lower than mSMR and PMR (1.44, 95% CI = 1.10–1.87) – derived on basis of PMR studies<br>Based on eight analyses<br>Heterogeneity—not significant at the 10% level           |
| Malignant melanoma        | Possible                              | 1.32 (1.10–1.57)               | Slightly higher than mSMR and PMR (1.29, 95% CI = 0.66–2.20)<br>Based on 10 analyses<br>Heterogeneity—not significant at the 10% level   |
| Brain                     | Possible                              | 1.32 (1.12–1.54)               | Slightly higher than mSMR and PMR (1.27, 95% CI = 0.96–1.63)<br>Based on 19 analyses<br>Heterogeneity—not significant at the 10% level; there was heterogeneity among SMR studies    |
| Rectum                    | Possible                              | 1.29 (1.10–1.51)               | Slightly lower than mSMR and PMR (1.39, 95% CI = 1.12–1.70)<br>Based on 13 analyses<br>Heterogeneity—not significant at the 10% level  |
| Buccal cavity and pharynx | Possible                              | 1.23 (0.96–1.55)               | Slightly higher than mSMR (1.18, 95% CI = 0.81–1.66)<br>Based on nine analyses<br>Heterogeneity—not significant at the 10% level   |
| Stomach                   | Possible                              | 1.22 (1.04–1.44)               | Lower than mSIR (1.56, 95% CI = 1.12–2.16);<br>Based on 13 analyses<br>Heterogeneity—not significant at the 10% level  |
| Colon                     | Possible                              | 1.21 (1.03–1.41)               | Slightly lower than mSMR and PMR (1.31, 95% CI = 1.06–1.59)<br>Based on 25 analyses<br>Heterogeneity—significant at the 10% level; there was heterogeneity among SMR and PMR studies |
| Leukemia                  | Possible                              | 1.14 (0.98–1.31)               | Similar to mSMR and PMR (1.14, 95% CI = 0.92–1.39)<br>Based on eight analyses<br>Heterogeneity—not significant at the 10% level  |
| Larynx                    | Unlikely                              | 1.22 (0.87–1.70)               | Higher than mSMR (0.58, 95% CI = 0.25–1.15)<br>Based on seven analyses<br>Heterogeneity—not significant at the 10% level   |
| Bladder                   | Unlikely                              | 1.20 (0.97–1.48)               | Similar to mSMR and PMR (1.24, 95% CI = 0.83, 1.49)<br>Based on 11 analyses<br>Heterogeneity—significant at the 10% level; there was heterogeneity among SMR studies                 |
| Esophagus                 | Unlikely                              | 1.16 (0.86–1.57)               | Higher than mSMR (0.68, 95% CI = 0.39–1.06)<br>Based on eight analyses<br>Heterogeneity—not significant at the 10% level   |
| Pancreas                  | Unlikely                              | 1.10 (0.91–1.34)               | Slightly higher than mSMR (0.98, 95% CI = 0.75–1.26)<br>Based on 13 analyses<br>Heterogeneity—not significant at the 10% level   |
| Kidney                    | Unlikely                              | 1.07 (0.78–1.48)               | Similar to mSMR and PMR (1.23, 95% CI = 0.94–1.59)<br>Based on 12 analyses<br>Heterogeneity—significant at the 10% level; there was heterogeneity among SMR studies                  |

(Continued)

**TABLE 5**  
Continued

| Cancer Site       | Likelihood of Cancer Risk by Criteria | Summary Risk Estimate (95% CI) | Comments  |
|-------------------|---------------------------------------|--------------------------------|---|
| Hodgkin's disease | Unlikely                              | 1.07 (0.59–1.92)               | Higher than mSMR (0.78, 95% CI = 0.21–2.01)<br>Based on three analyses<br>Heterogeneity—not significant at the 10% level  |
| Liver             | Unlikely                              | 1.04 (0.72–1.49)               | Similar to mSMR (1.00, 95% CI = 0.63–1.52)<br>Based on seven analyses<br>Heterogeneity—not significant at the 10% level   |
| Lung              | Unlikely                              | 1.03 (0.97–1.08)               | Similar to mSMR and PMR (1.05, 95% CI = 0.96–1.14)<br>Based on 19 analyses<br>Heterogeneity—not significant at the 10% level; there was heterogeneity among PMR studies |
| All cancers       | Unlikely                              | 1.06 (1.00–1.09)               | Similar to mSMR and PMR (1.06, 95% CI = 1.02–1.10)<br>Based on 25 analyses<br>Heterogeneity—significant at the 10% level; there was heterogeneity among SMR studies     |

CI indicates confidence interval; SMR, standardized mortality ratio; PMR, proportional mortality ratio; SIR, standardized incidence ratio.



**APPENDIX A-15: TABLES AND FIGURES FROM [BATES 2007]****TABLE I.** Demographic Characteristics of Firefighter and Non-firefighter Cancer Cases, California Cancer Registry, 1988–2003

| Characteristic                       | Firefighters |         | Non-firefighters |         |
|--------------------------------------|--------------|---------|------------------|---------|
|                                      | Number       | Percent | Number           | Percent |
| Age at diagnosis                     |              |         |                  |         |
| • 21–30                              | 67           | 2.10    | 19,499           | 2.44    |
| • 31–40                              | 185          | 5.06    | 40,472           | 5.06    |
| • 41–50                              | 361          | 9.87    | 73,209           | 9.15    |
| • 51–60                              | 821          | 22.4    | 153,775          | 19.22   |
| • 61–70                              | 1307         | 35.7    | 272,290          | 34.08   |
| • 71–80                              | 908          | 24.8    | 240,703          | 30.07   |
| Race/ethnicity                       |              |         |                  |         |
| • Non-Hispanic white                 | 3,345        | 91.42   | 602,763          | 75.30   |
| • Non-Hispanic black                 | 79           | 2.16    | 53,653           | 6.69    |
| • Hispanic                           | 178          | 4.86    | 86,143           | 10.76   |
| • Asian/Pacific Islander             | 31           | 0.85    | 47,174           | 5.89    |
| • American Indian/Alaskan native     | 1            | 0.03    | 888              | 0.11    |
| • Other/unknown                      | 25           | 0.68    | 9,917            | 1.24    |
| Socio-economic quintile of residence |              |         |                  |         |
| • 1 (lowest)                         | 231          | 6.31    | 107,124          | 13.38   |
| • 2                                  | 628          | 17.16   | 147,462          | 18.42   |
| • 3                                  | 843          | 23.04   | 167,107          | 20.88   |
| • 4                                  | 1,003        | 27.41   | 179,775          | 22.46   |
| • 5 (highest)                        | 954          | 26.07   | 198,980          | 24.86   |
| Year of diagnosis                    |              |         |                  |         |
| • 1988–1991                          | 742          | 20.28   | 193,028          | 24.11   |
| • 1992–1995                          | 917          | 25.06   | 219,854          | 27.47   |
| • 1996–1999                          | 985          | 26.92   | 190,896          | 23.85   |
| • 2000–2003                          | 1,015        | 27.74   | 196,670          | 24.57   |
| Total                                | 3,659        | 100     | 800,448          | 100     |

**TABLE II.** Results of Logistic Regression Analyses, with and without Control Exclusions

| Cancer site            | SEER codes <sup>a</sup> | Number of firefighters | No control exclusions |           | Control exclusions <sup>b</sup> |           |
|------------------------|-------------------------|------------------------|-----------------------|-----------|---------------------------------|-----------|
|                        |                         |                        | OR <sup>c</sup>       | 95% CI    | OR <sup>c</sup>                 | 95% CI    |
| Esophagus              | 21010                   | 62                     | 1.37                  | 1.06–1.76 | 1.48                            | 1.14–1.91 |
| Stomach                | 21020                   | 51                     | 0.77                  | 0.58–1.02 | 0.80                            | 0.61–1.07 |
| Cecum                  | 21041                   | 52                     | 1.03                  | 0.78–1.35 | 1.09                            | 0.82–1.44 |
| Colo-rectal            | 21043–8                 | 282                    | 0.84                  | 0.74–0.94 | 0.90                            | 0.79–1.03 |
| Pancreas               | 21100                   | 63                     | 0.85                  | 0.66–1.09 | 0.90                            | 0.70–1.17 |
| Lung & bronchus        | 22030                   | 495                    | 0.92                  | 0.84–1.01 | 0.98                            | 0.88–1.09 |
| Melanoma–skin          | 25010                   | 323                    | 1.44                  | 1.28–1.62 | 1.50                            | 1.33–1.70 |
| Prostate               | 28010                   | 1,144                  | 1.20                  | 1.12–1.29 | 1.22                            | 1.12–1.33 |
| Testis                 | 28020                   | 70                     | 1.34                  | 1.04–1.74 | 1.54                            | 1.18–2.02 |
| Bladder                | 29010                   | 174                    | 0.79                  | 0.68–0.92 | 0.85                            | 0.72–1.00 |
| Kidney & renal pelvis  | 29020                   | 101                    | 0.98                  | 0.81–1.20 | 1.07                            | 0.87–1.31 |
| Brain                  | 31010                   | 71                     | 1.23                  | 0.97–1.56 | 1.35                            | 1.06–1.72 |
| Thyroid                | 32010                   | 32                     | 1.06                  | 0.75–1.51 | 1.17                            | 0.82–1.67 |
| Non-Hodgkin's lymphoma | 33041–2                 | 159                    | 0.98                  | 0.84–1.15 | 1.07                            | 0.90–1.26 |
| Multiple myeloma       | 34000                   | 37                     | 0.97                  | 0.70–1.34 | 1.03                            | 0.75–1.43 |
| Leukemias              | 35011–43                | 100                    | 1.13                  | 0.92–1.37 | 1.22                            | 0.99–1.49 |

<sup>a</sup>Surveillance Epidemiology and End Results (SEER) codes available at: <http://seer.cancer.gov/siterecode/icdo3.d01272003/>.

<sup>b</sup>Excluded from control groups were cancers of the lung and bronchus, bladder and prostate, colo-rectal cancers, and skin melanomas.

<sup>c</sup>All models adjusted for age, calendar period of diagnosis, race, and an indicator of socio-economic status for the census block of residence.

**TABLE III.** Comparison of Results for 1988–1995 and 1996–2003 in Subjects Aged 21–60

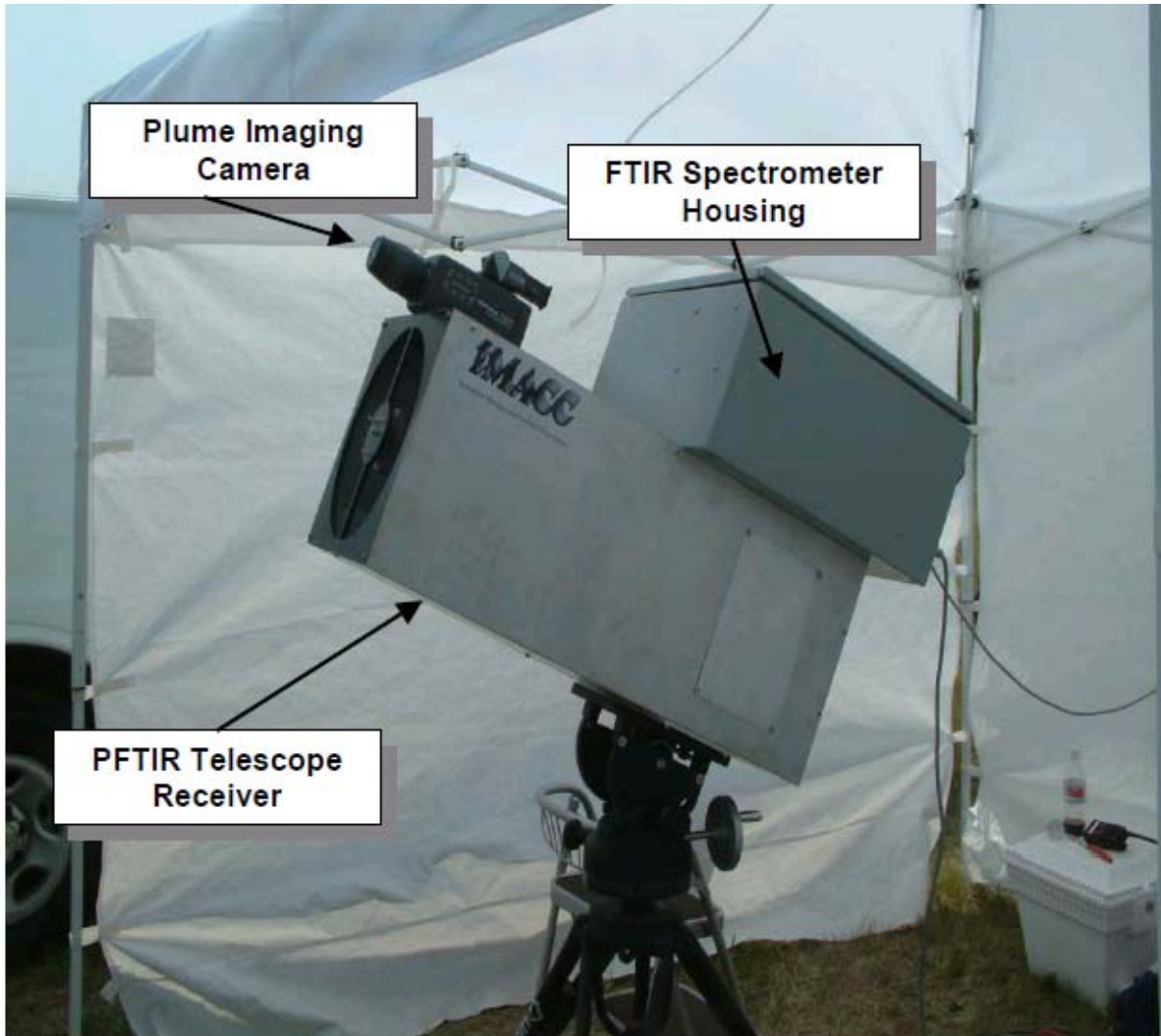
| Cancer site            | SEER codes <sup>a</sup> | 1988–1995        |                 |           | 1996–2003        |                 |           |
|------------------------|-------------------------|------------------|-----------------|-----------|------------------|-----------------|-----------|
|                        |                         | No. <sup>b</sup> | OR <sup>c</sup> | 95% CI    | No. <sup>b</sup> | OR <sup>c</sup> | 95% CI    |
| Esophagus              | 21010                   | 8                | 1.36            | 0.67–2.78 | 15               | 1.86            | 1.10–3.14 |
| Stomach                | 21020                   | 13               | 1.31            | 0.75–2.99 | 7                | 0.64            | 0.30–1.36 |
| Cecum                  | 21041                   | 6                | 1.07            | 0.48–2.43 | 8                | 1.16            | 0.58–2.36 |
| Colo-rectal            | 21043–8                 | 48               | 1.14            | 0.83–1.56 | 62               | 1.18            | 0.89–1.55 |
| Pancreas               | 21100                   | 11               | 1.16            | 0.63–2.13 | 9                | 0.74            | 0.38–1.45 |
| Lung & bronchus        | 22030                   | 62               | 0.85            | 0.64–1.14 | 47               | 0.77            | 0.56–1.05 |
| Melanoma–skin          | 25010                   | 74               | 1.55            | 1.19–2.01 | 128              | 1.86            | 1.51–2.29 |
| Prostate               | 28010                   | 89               | 1.46            | 1.12–1.91 | 214              | 1.55            | 1.28–1.88 |
| Testis                 | 28020                   | 37               | 1.92            | 1.32–2.80 | 32               | 1.29            | 0.87–1.92 |
| Bladder                | 29010                   | 18               | 0.71            | 0.44–1.14 | 27               | 0.94            | 0.63–1.40 |
| Kidney & renal pelvis  | 29020                   | 24               | 1.47            | 0.96–2.24 | 22               | 0.87            | 0.57–1.35 |
| Brain                  | 31010                   | 22               | 1.63            | 1.05–2.52 | 19               | 1.08            | 0.68–1.72 |
| Thyroid                | 32010                   | 12               | 1.54            | 0.86–2.76 | 14               | 1.15            | 0.67–1.98 |
| Non-Hodgkin's lymphoma | 33041–2                 | 42               | 1.03            | 0.74–1.43 | 38               | 0.94            | 0.67–1.32 |
| Multiple myeloma       | 34000                   | 9                | 1.85            | 0.95–3.61 | 10               | 1.41            | 0.75–2.65 |
| Leukemias              | 35011–43                | 18               | 1.18            | 0.73–1.90 | 19               | 1.06            | 0.67–1.69 |

<sup>a</sup>Surveillance Epidemiology and End Results (SEER) codes available at: <http://seer.cancer.gov/siterecode/icdo3.d01272003/>.

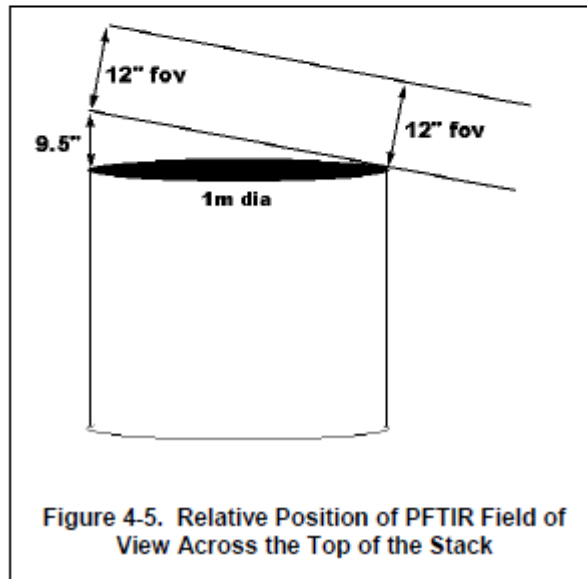
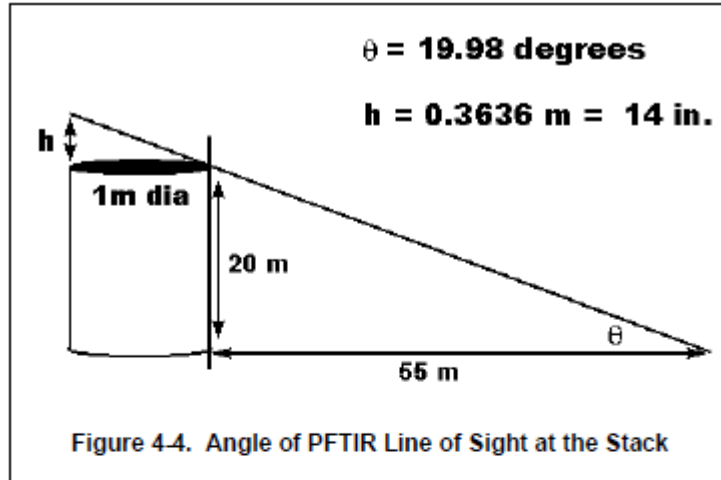
<sup>b</sup>Number of firefighters with cancer type.

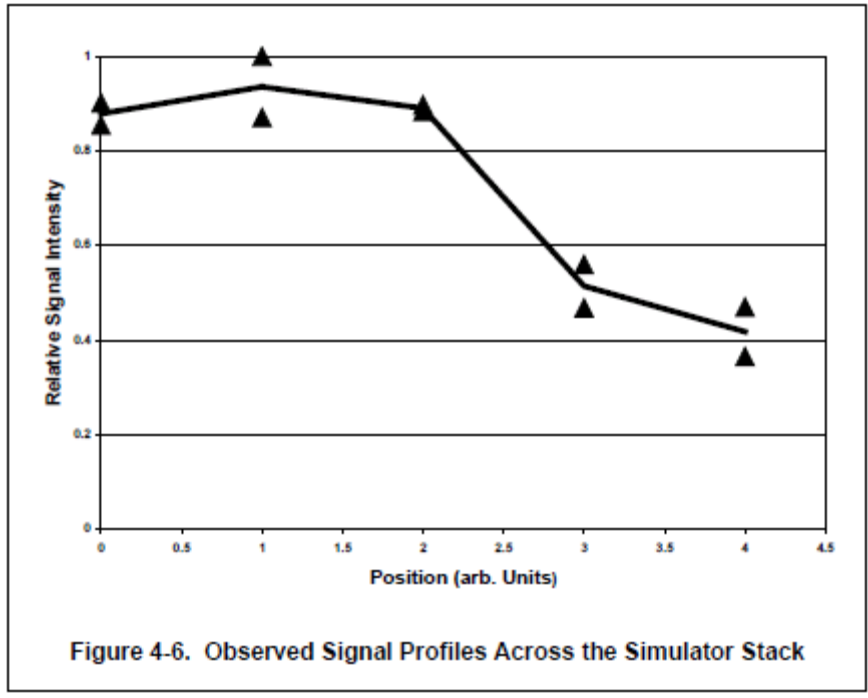
<sup>c</sup>All models adjusted for age, calendar period of diagnosis, race, and an indicator of socio-economic status for the census block of residence. Excluded from control groups were cancers of the lung and bronchus, bladder and prostate, colo-rectal cancers, and skin melanomas.

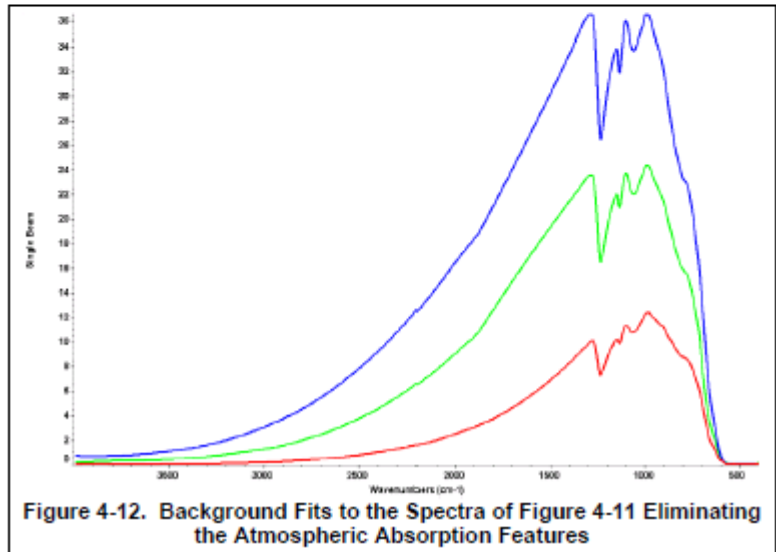
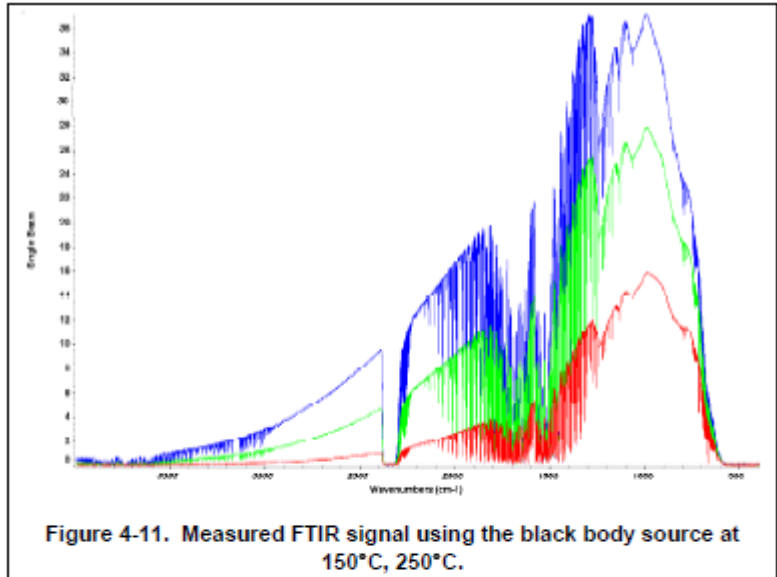
**APPENDIX A-16: TABLES AND FIGURES FROM [URS CORPORATION  
2004]**



**Figure 1-2. Photograph of Passive Fourier Transform Infrared (PFTIR) Spectrometer**







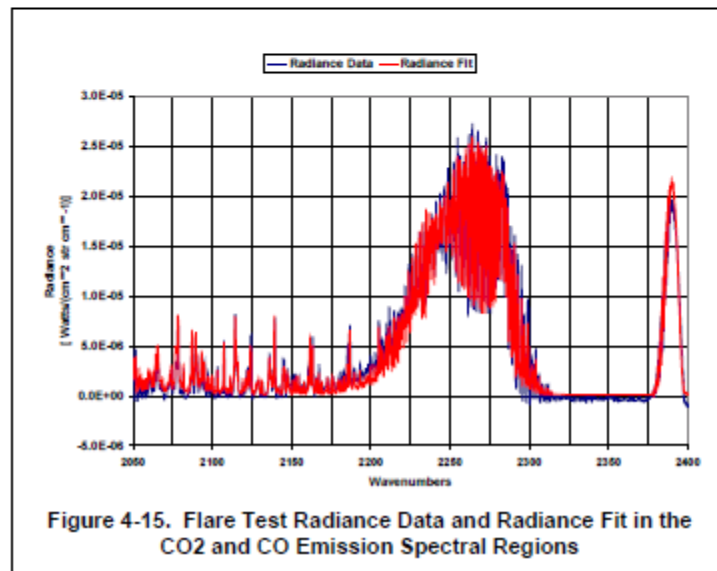
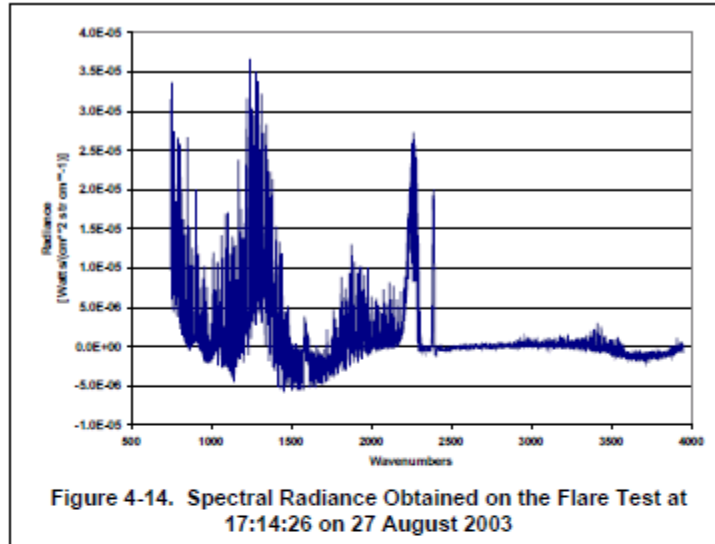


Table 4-8. PFTIR Conformance to TCEQ Quality Control Requirements

| Requirement   | Method of Conformance  |
|---|--|
| Define the system's working range using a multipoint calibration curve for each target compound.  | The working range was determined by the tests being performed in this study. Estimates were generated in a laboratory analytical study and demonstrated in the field tests.  |
| Demonstrate contamination potential from sampling and preparation procedures using media blanks and equipment blanks.   | Before and after each spiking test, measurements were made on hot ambient air blanks drawn through the plume generator. For the controlled flare tests, ambient air blanks were obtained by aiming the PFTIR to the side and upwind of the flare.  |
| Demonstrate analytical equipment contamination potential using instrument blanks immediately after the highest concentration in calibration curve.  | See above.   |
| Demonstrate calibration bias and measurement precision by analyzing a second source standard four times (minimum).  | Each test consisted of 15-20 individual spectra. These were independently reduced allowing for a standard deviation of the results to be computed and compared to the analysis of a "mean" spectrum. Radiance calibrations was performed each day of testing to correct for any calibration drifts.  |
| Demonstrate calibration accuracy by analyzing a second source standard.   | The accuracy was based on the comparison between the measured spectra, the known spiking compounds, and the standard spectrum for each compound in the spectral library. The PFTIR results were compared with computed concentrations based on metered flows and EFTIR measurements in the plume generator tests.  |
| Determine method detection limits (MDLs) according to 40 <i>Code of Federal Regulations</i> (CFR) Part 136, Appendix B (i.e., measuring variability of seven replicate spikes), and then test these MDLs by analyzing a low level standard. | Data were gathered on heated air blank samples in the plume generator at the same temperature as typical simulations. Because the concentrations in this flow were low and constant (as constant as the ambient air levels), these spectra were used to determine a standard deviation of the gas concentrations deduced from the analysis procedures. Three times the standard deviation of these concentrations were then used as the MDL level. |



Table 4-8. (continued)

| Requirement  | Method of Conformance   |
|--|---|
| Evaluate collection efficiency, maximum sample volume, sample storage effects, and desorption/extraction efficiency.   | The equivalent for the PFTIR is to observe three areas across the apparent width of the plume to ensure that the field of view of the instrument is filled by the plume. This also provides a measure of the gradient across the plume.   |
| Determine known or suspected limitations (interferences and mixed matrix effects).   | This was determined by analytical studies that preceded the field tests. Tests No. 4 and No. 5 of the plume generator test series were used to determine this through spectral residual measurements, if sufficient signal was observed for the interfering compounds.  |
| During routine sample analysis, use control samples to prove the method and monitoring system performance are operating within acceptable limits.  | Control sample equivalents are the flow metered gas mixture and the confirmatory in-stack EFTIR measurements in the plume generator tests.  |
| Ensure each extraction batch QC consists, at a minimum, of samples to check bias, contamination and precision.   | Potential bias was determined by Tests No. 1 through 5 of the plume generator test series. Contamination was evaluated using results of the heated air test periods between plume generator tests and from the triplicate heated air test conducted at the end of the plume generator test series. Precision was determined from the results of plume generator test Test No. 3 in which three replicate measurements were conducted. |
| For each batch, ensure a control duplicate is used to check instrument calibration and bias (calibration verification standard or laboratory control sample), blank(s) to assess contamination, and duplicates to measure precision and field samples. | The instrument is calibrated against a blackbody radiation calibration standard, which is NITS traceable. Radiation is calibrated against the Planck function for the controlled temperature of the source and it is known emissivity.  |

Table 5-2. Minimum Detectable Gas Concentrations from Simulations at 150°C, 225°C, and 232°C

|              | Peak Radiance             |                       | Ref. Conc. (ppm) | Ref. Path (m) | Noise limited (ppm*m) |                       |
|--------------|---------------------------|-----------------------|------------------|---------------|-----------------------|-----------------------|
|              | 900-1000 cm <sup>-1</sup> | 3000 cm <sup>-1</sup> |                  |               | 1000 cm <sup>-1</sup> | 3000 cm <sup>-1</sup> |
| <b>150°C</b> |                           |                       |                  |               |                       |                       |
| CO           | 2.50E-07                  |                       | 20               | 1             | 1.360                 |                       |
| (C2H4)       | 7.03E-07                  |                       | 9.9              | 1             | 0.187                 |                       |
| (C3H6)       | 1.39E-06                  |                       | 75               | 1             | 0.718                 |                       |
| (C3H8)       | 6.58E-09                  | 2.62E-08              | 20               | 1             | 40.426                | 25.19                 |
| (C4H10)      | 1.39E-06                  |                       | 73               | 1             | 0.698                 |                       |
| THC          |                           | 8.92E-08              | 30               | 2             |                       | 20.20                 |
| THC - InSb*  |                           |                       |                  |               |                       | 2.22                  |
| <b>225°C</b> |                           |                       |                  |               |                       |                       |
| CO           | 3.50E-07                  |                       | 20               | 1             | 0.971                 |                       |
| (C2H4)       | 1.17E-06                  |                       | 9.9              | 1             | 0.113                 |                       |
| (C3H6)       | 2.30E-06                  |                       | 75               | 1             | 0.434                 |                       |
| (C3H8)       | 1.00E-08                  | 1.20E-07              | 20               | 1             | 26.600                | 5.50                  |
| (C4H10)      | 2.30E-06                  |                       | 73               | 1             | 0.422                 |                       |
| THC          |                           | 4.08E-07              | 30               | 2             |                       | 4.86                  |
| THC - InSb*  |                           |                       |                  |               |                       | 0.49                  |
| <b>232°C</b> |                           |                       |                  |               |                       |                       |
| CO           | 3.80E-07                  |                       | 20               | 1             | 0.895                 |                       |
| (C2H4)       | 1.20E-06                  |                       | 9.9              | 1             | 0.110                 |                       |
| (C3H6)       | 2.37E-06                  |                       | 75               | 1             | 0.421                 |                       |
| (C3H8)       | 1.06E-08                  | 1.34E-07              | 20               | 1             | 25.094                | 4.93                  |
| (C4H10)      | 2.33E-06                  |                       | 73               | 1             | 0.417                 |                       |
| THC          |                           | 4.60E-07              | 30               | 2             |                       | 4.31                  |
| THC - InSb*  |                           | 4.60E-07              | 30               | 2             |                       | 0.431                 |

\* Noise levels from LN2 source measurements (Watts/cm<sup>2</sup>/str/cm<sup>2</sup>)

\* Estimated improvement in detection based upon InSb detector sensitivity compared to HgCdTe.

Table 5-7. Plume Generator Tests - Comparison of Average Gas Concentrations

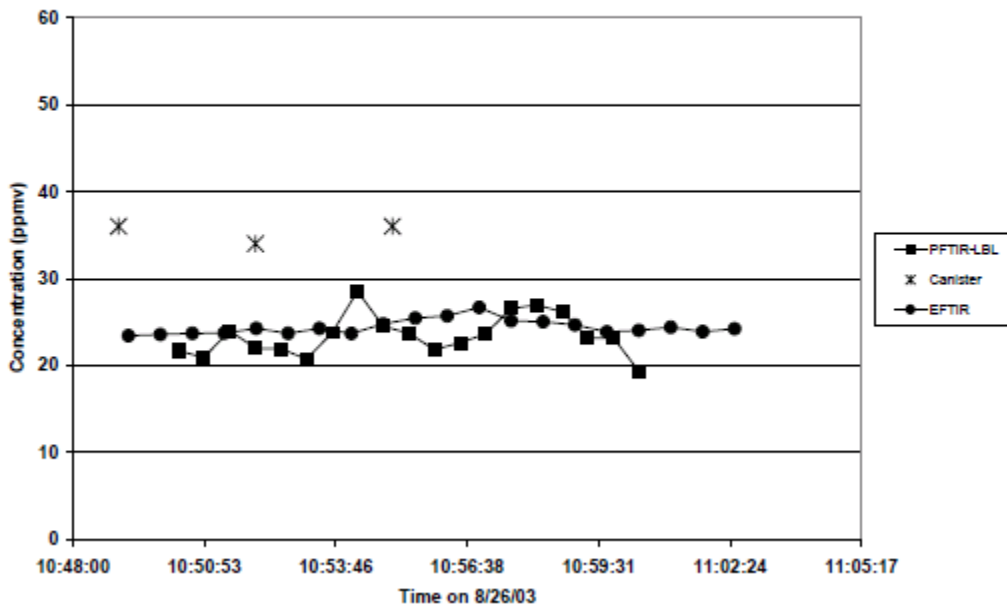
| TEST      | CO           |                    |         | CO <sub>2</sub> |                    |         | Butane       |                    |         | Ethylene     |                    |         | Propylene       |                    |         | Propane          |                    |         |
|-----------|--------------|--------------------|---------|-----------------|--------------------|---------|--------------|--------------------|---------|--------------|--------------------|---------|-----------------|--------------------|---------|------------------|--------------------|---------|
|           | EFTIR (ppmv) | PFTIR (LBL) (ppmv) | % Error | EFTIR (ppmv)    | PFTIR (LBL) (ppmv) | % Error | EFTIR (ppmv) | PFTIR (LBL) (ppmv) | % Error | EFTIR (ppmv) | PFTIR (LBL) (ppmv) | % Error | EFTIR (ppmv)    | PFTIR (LBL) (ppmv) | % Error | EFTIR (ppmv)     | PFTIR (LBL) (ppmv) | % Error |
| Test 1a   | 144          | 113                | 22      | 7,270           | 3,549              | 51      | 83           | 23                 | 72      | BDL          | -1.5               | -       | BDL             | 44                 | -       | -                | -                  | -       |
| Test 2a   | 74           | 65                 | 12      | 6,600           | 4,017              | 39      | 55           | 4                  | 93      | 29           | 18                 | 38      | 36              | 60                 | 67      | -                | -                  | -       |
| Test 3a   | 24           | 23                 | 4       | 6,750           | 3,365              | 50      | 22           | -1                 | -       | 18           | 10                 | 44      | 21              | 53                 | 152     | -                | -                  | -       |
| Test 4a   | 74           | 112                | 51      | 6,970           | 8,123              | 17      | 64           | 16                 | 75      | 29           | 27                 | 7       | 34              | 96                 | 182     | -                | -                  | -       |
| Test 5a   | 24           | 46                 | 92      | 6,980           | 7,996              | 15      | 26           | 25                 | 4       | 18           | 15                 | 17      | 21              | 85                 | 305     | -                | -                  | -       |
| Test 4b   | 74           | 96                 | 30      | 6,580           | 6,368              | 3       | 63           | 17                 | 73      | 28           | 22                 | 21      | 33              | 85                 | 158     | -                | -                  | -       |
| Test 5b   | 24           | 45                 | 88      | 6,740           | 8,238              | 22      | 27           | 26                 | 4       | 18           | 15                 | 17      | 20              | 79                 | 295     | -                | -                  | -       |
| Test 2b   | 73           | 91                 | 25      | 6,960           | 6,354              | 9       | 63           | 20                 | 68      | 28           | 22                 | 21      | 34              | 62                 | 82      | -                | -                  | -       |
| Test 3b-1 | 24           | 29                 | 21      | 6,340           | 5,700              | 10      | 27           | 7                  | 74      | 18           | 11                 | 39      | 20              | 43                 | 115     | -                | -                  | -       |
| Test 3b-2 | 24           | 25                 | 4       | 6,340           | 4,575              | 28      | 27           | 4                  | 85      | 18           | 10                 | 44      | 20              | 46                 | 130     | -                | -                  | -       |
| Test 3b-3 | 24           | 26                 | 8       | 6,330           | 4,663              | 26      | 29           | 5                  | 83      | 18           | 11                 | 39      | 11 <sup>a</sup> | 40                 | 264     | -                | -                  | -       |
| Test 1b   | 138          | -                  | -       | 6,570           | -                  | -       | -            | -                  | -       | BDL          | -                  | -       | BDL             | -                  | -       | 105 <sup>b</sup> | -                  | -       |

<sup>a</sup> CO supplies were exhausted near the end of this test period.

<sup>b</sup> Butane supplies were exhausted, therefore commercial grade propane from the Zink fuel supply system was substituted for butane during this test.

BDL = Below Detection Limit.

Test 3a: Carbon Monoxide



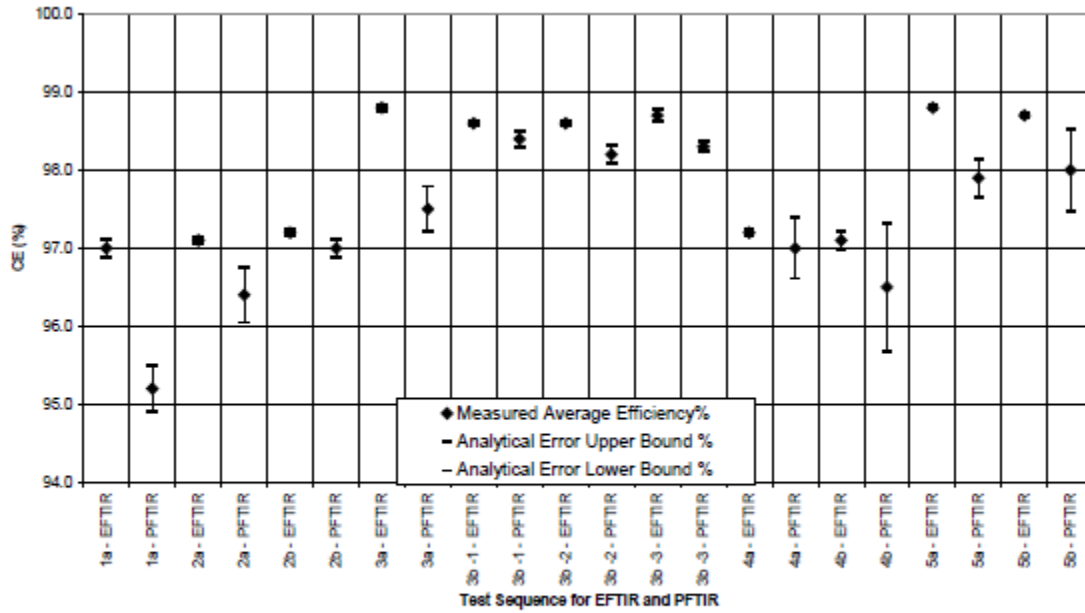


Figure 5-12. Calculated Combustion Efficiencies with Uncertainty Bars for EFTIR and PFTIR

Table 5-20. Analytical Uncertainties for Combustion Efficiencies

| Test Condition | PFTIR         |                         | EFTIR         |                         |
|----------------|---------------|-------------------------|---------------|-------------------------|
|                | e(analytical) | e(analytical) + e(time) | e(analytical) | e(analytical) + e(time) |
| 1a             | 0.0054        | 0.300                   | 0.0025        | 0.115                   |
| 2a             | 0.0060        | 0.352                   | 0.0011        | 0.037                   |
| 2b             | 0.0021        | 0.118                   | 0.0005        | 0.034                   |
| 3a             | 0.0043        | 0.294                   | 0.0007        | 0.037                   |
| 3b-1           | 0.0017        | 0.108                   | 0.0002        | 0.024                   |
| 3b-2           | 0.0018        | 0.116                   | 0.0002        | 0.030                   |
| 3b-3           | 0.0011        | 0.062                   | 0.0007        | 0.080                   |
| 4a             | 0.0050        | 0.387                   | 0.0009        | 0.037                   |
| 4b             | 0.0104        | 0.822                   | 0.0013        | 0.114                   |
| 5a             | 0.0032        | 0.246                   | 0.0005        | 0.033                   |
| 5b             | 0.0041        | 0.526                   | 0.0003        | 0.034                   |

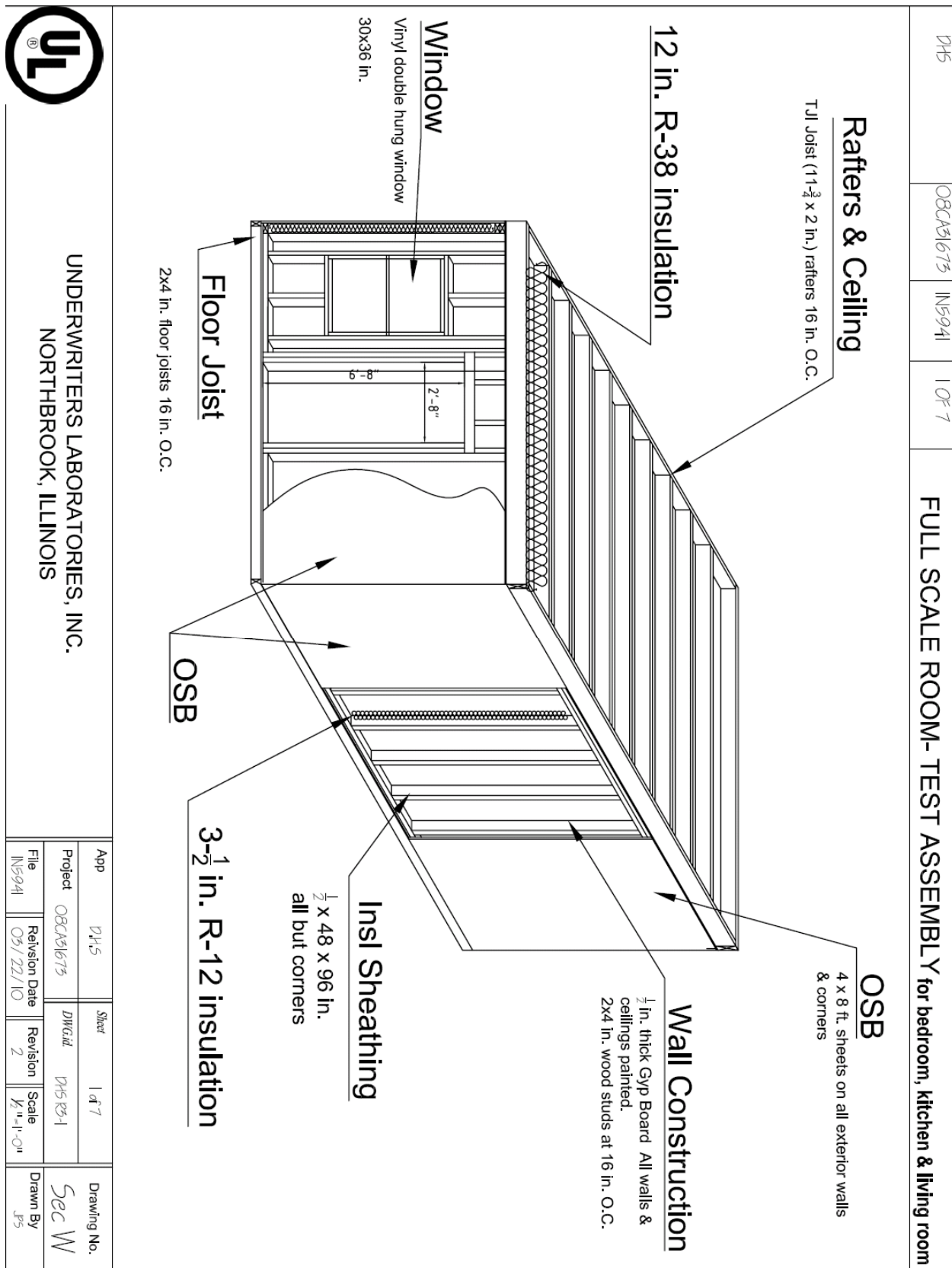
## **APPENDIX B: LARGE-SCALE FIRE TEST DRAWINGS**

### **B.0 OVERVIEW**

This section includes CAD drawings of the structures used for the large-scale tests and the location of instrumentation.

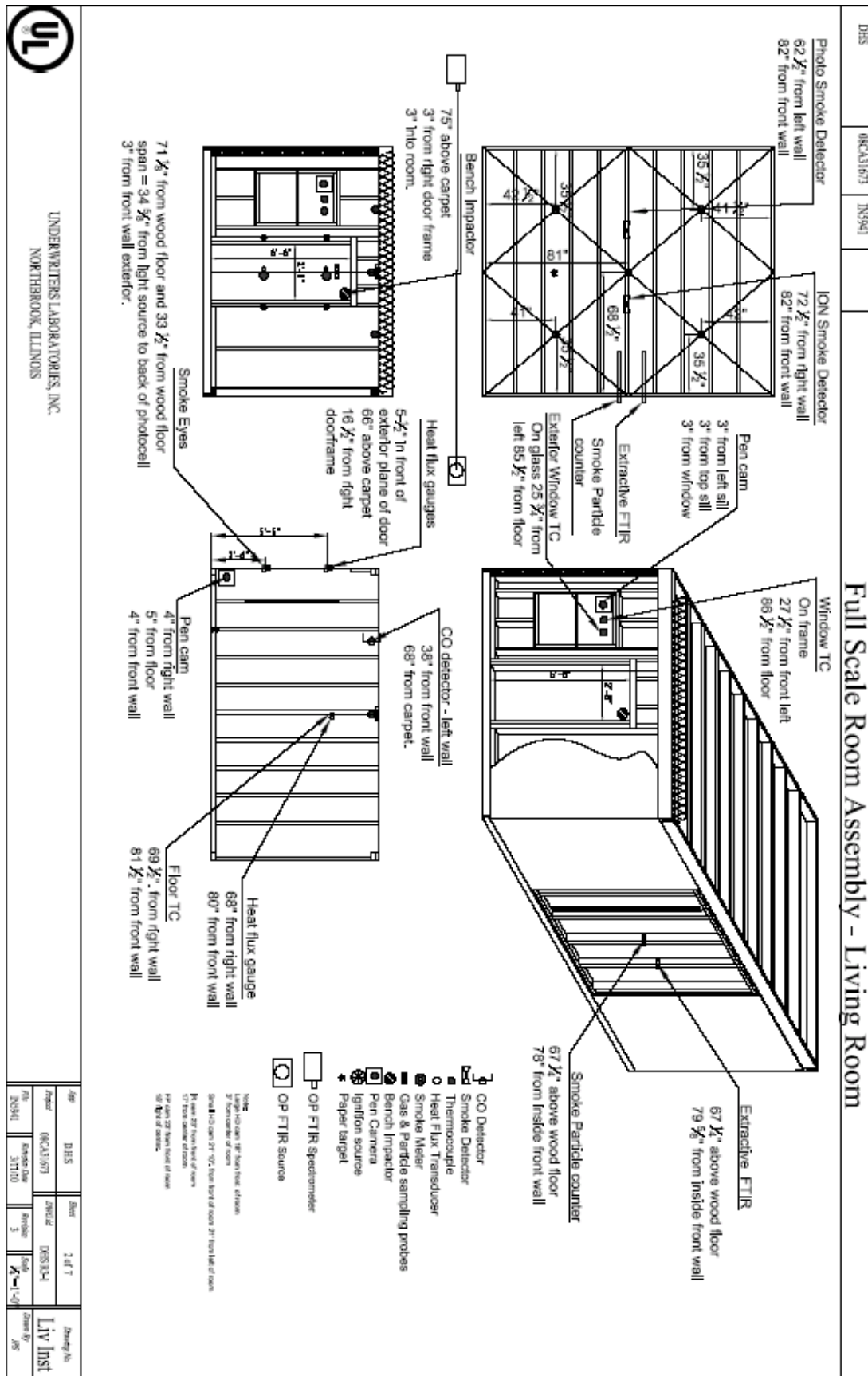
### **B.1 ORDER OF CAD DRAWINGS**

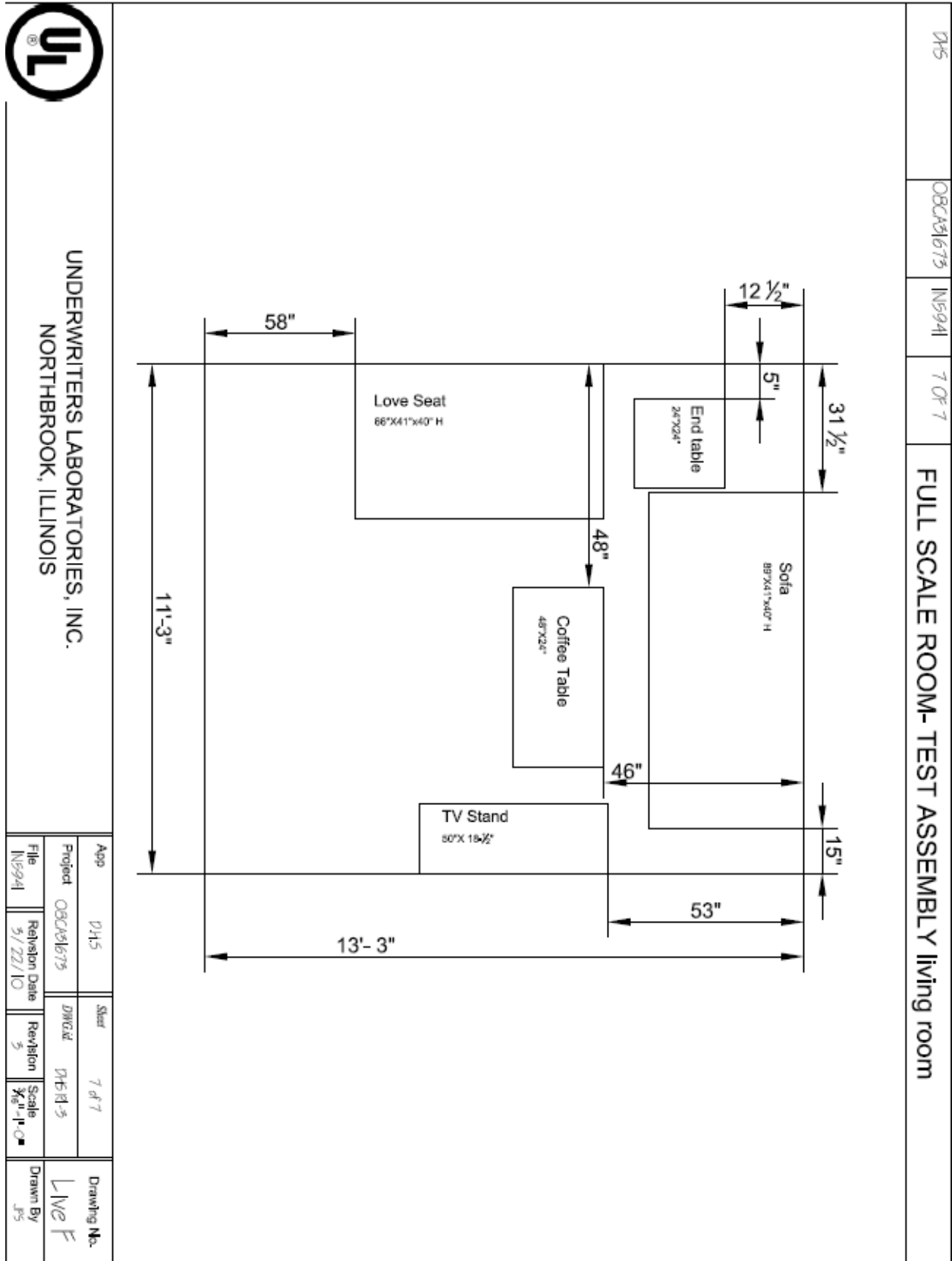
1. General construction for living rooms, bedroom, kitchen
2. Living room – instrumentation
3. Living room – furnishings layout
4. Limited ventilation living room – instrumentation
5. Limited ventilation living room – furnishings layout
6. Bedroom – instrumentation
7. Bedroom – furnishings layout
8. Kitchen – instrumentation
9. Kitchen – furnishings layout
10. General construction for attic
11. Attic – instrumentation
12. Attic – furnishings layout
13. General construction for wood deck
14. General construction for composite deck
15. Deck – furnishings layout
16. Automobile passenger compartment – instrumentation
17. Automobile engine compartment – instrumentation



UNDERWRITERS LABORATORIES, INC.  
NORTHBROOK, ILLINOIS

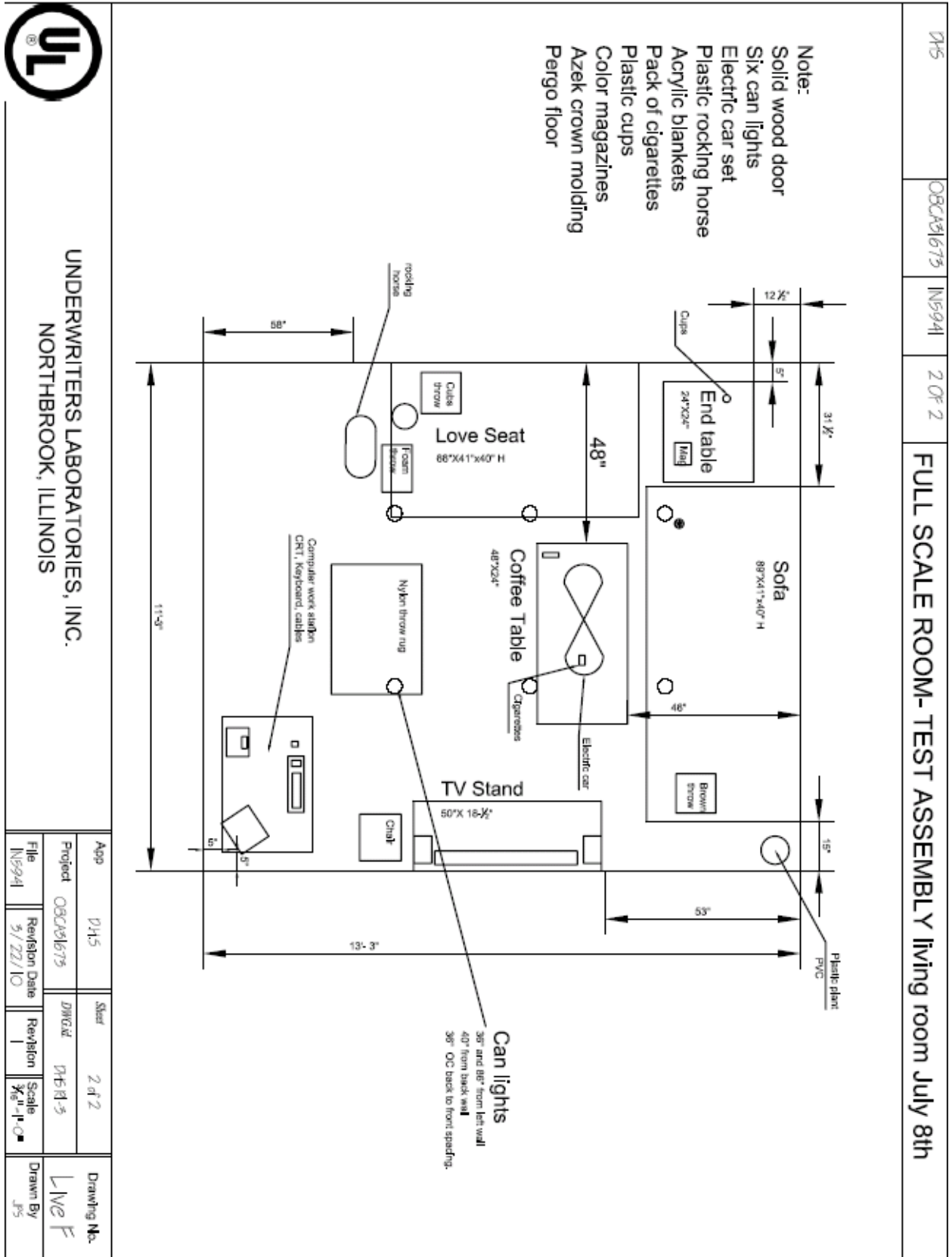
|         |           |               |              |             |       |
|---------|-----------|---------------|--------------|-------------|-------|
| App     | D145      | Sheet         | 1 of 7       | Drawing No. | Sec W |
| Project | 08CA31673 | Dir/Genl      | D145 R3-1    | Drawn By    | JPS   |
| File    | IN5941    | Revision Date | 03/22/10     | Revision    | 2     |
|         |           | Scale         | 1/2" = 1'-0" |             |       |

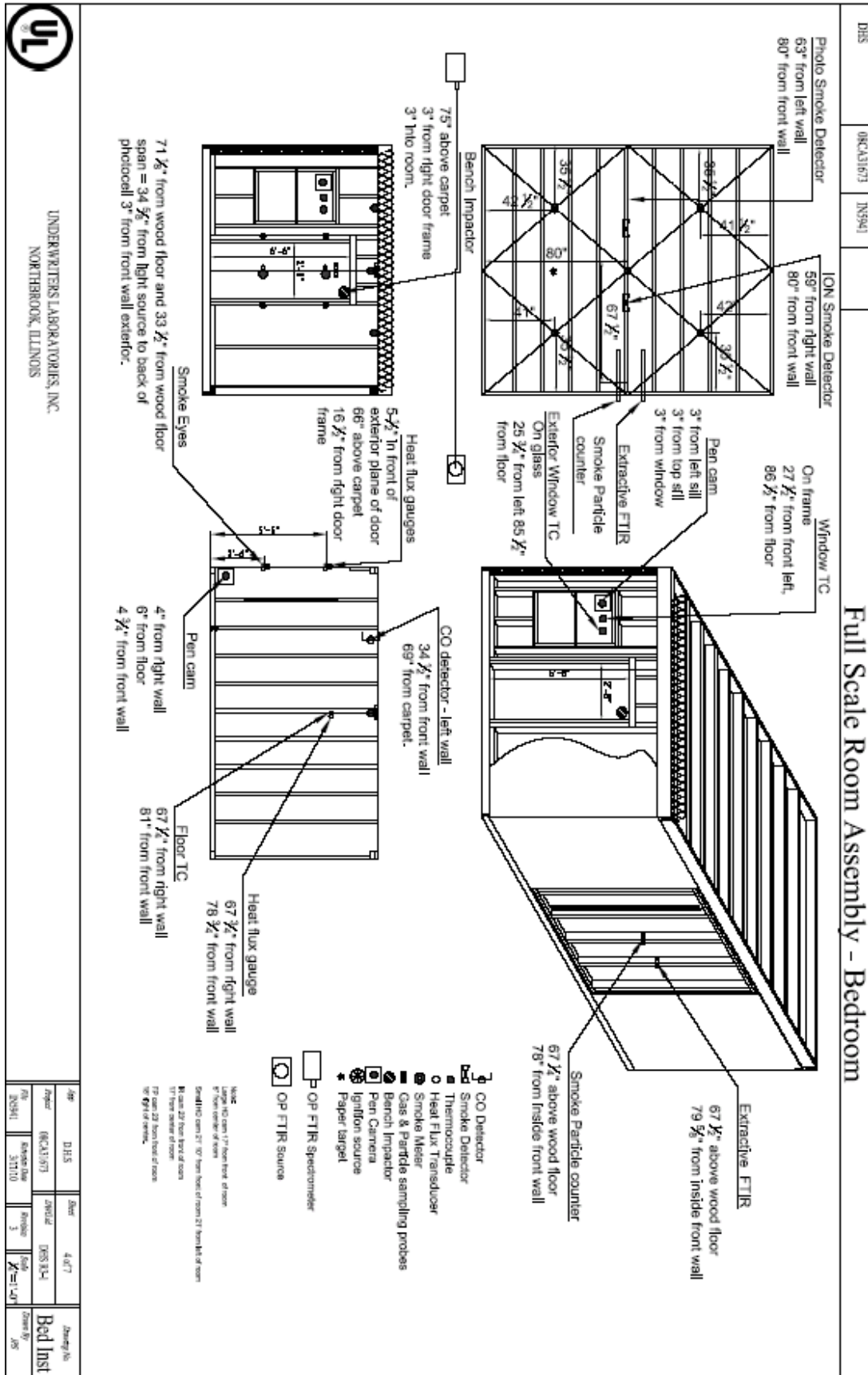


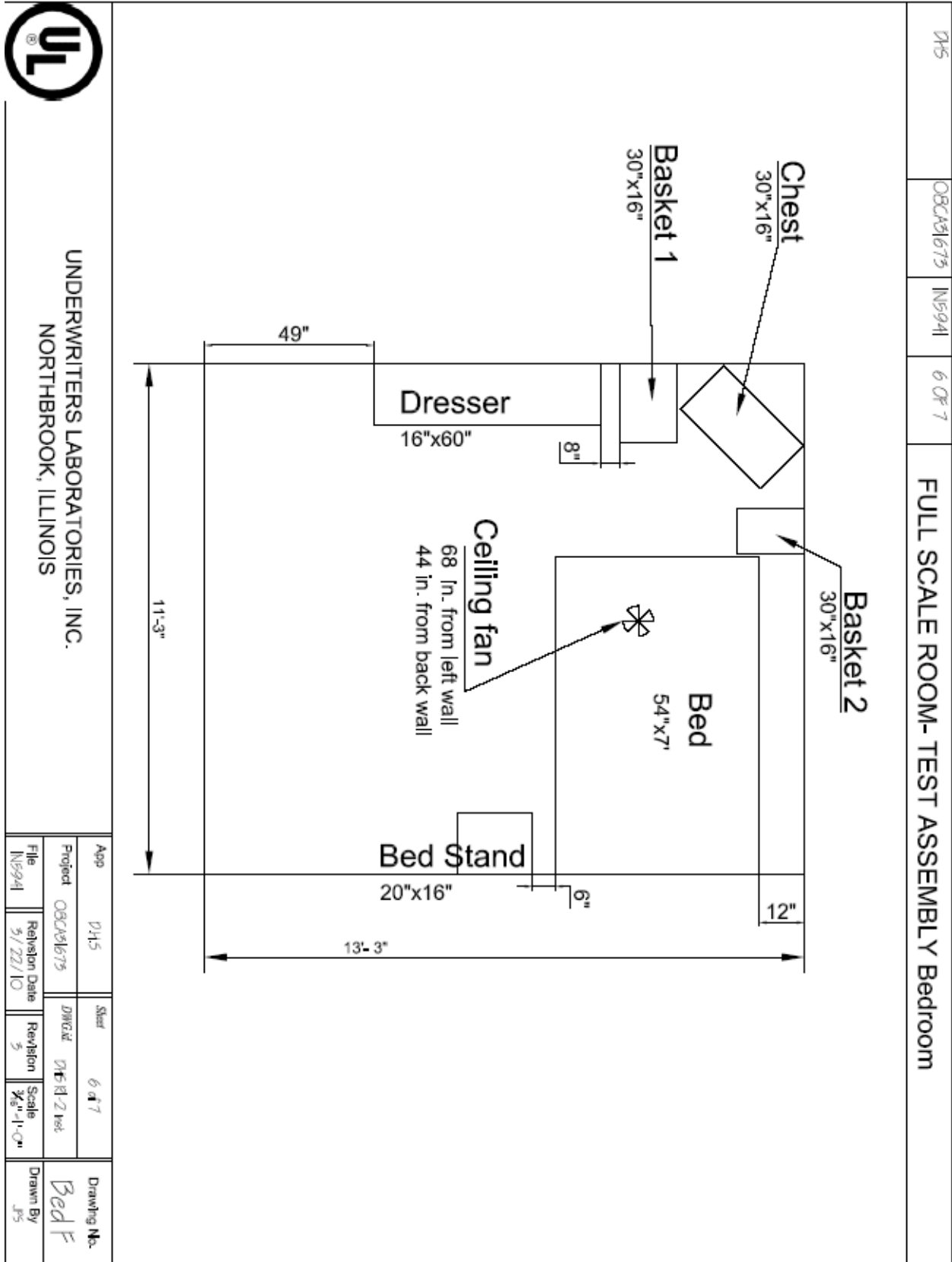


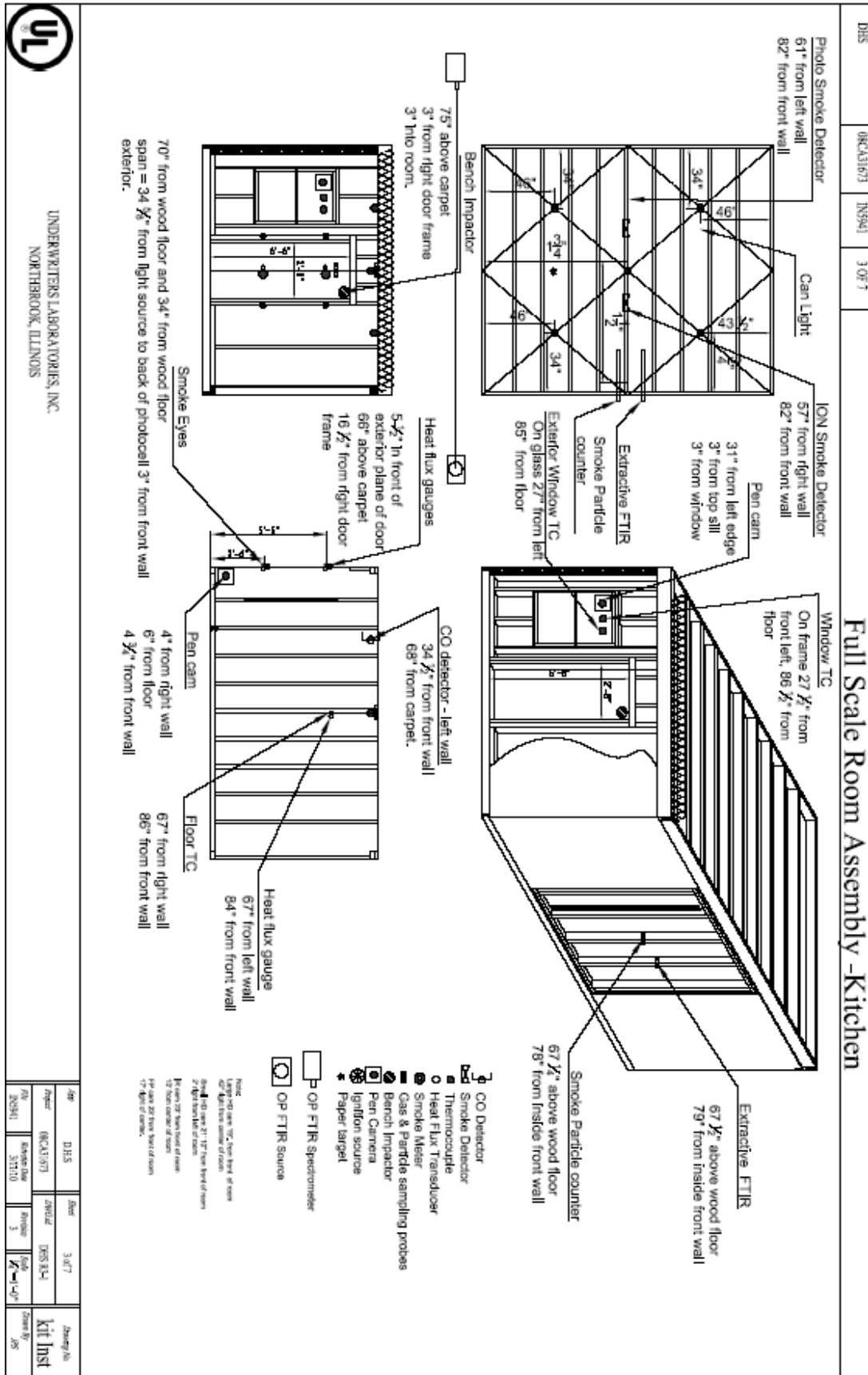


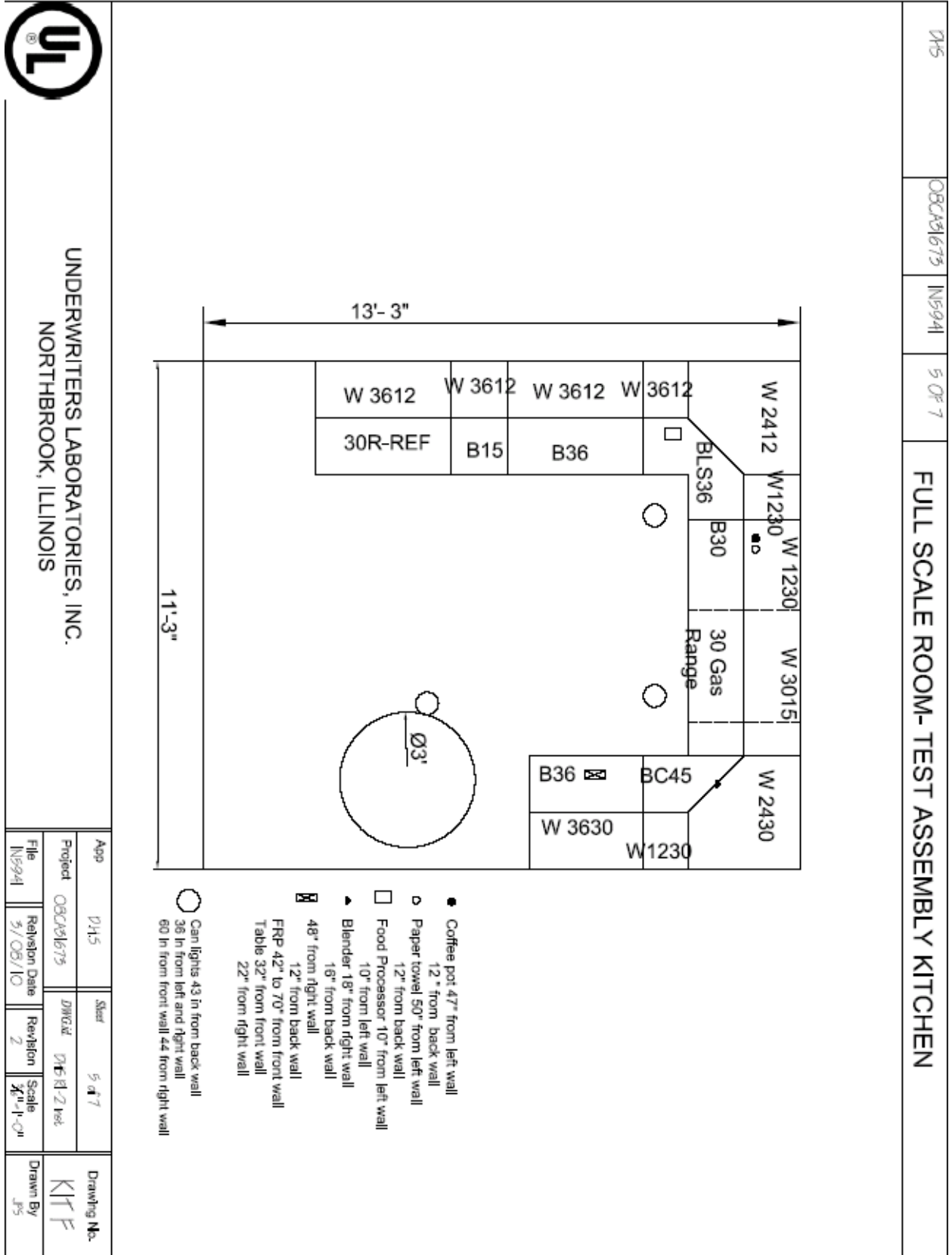


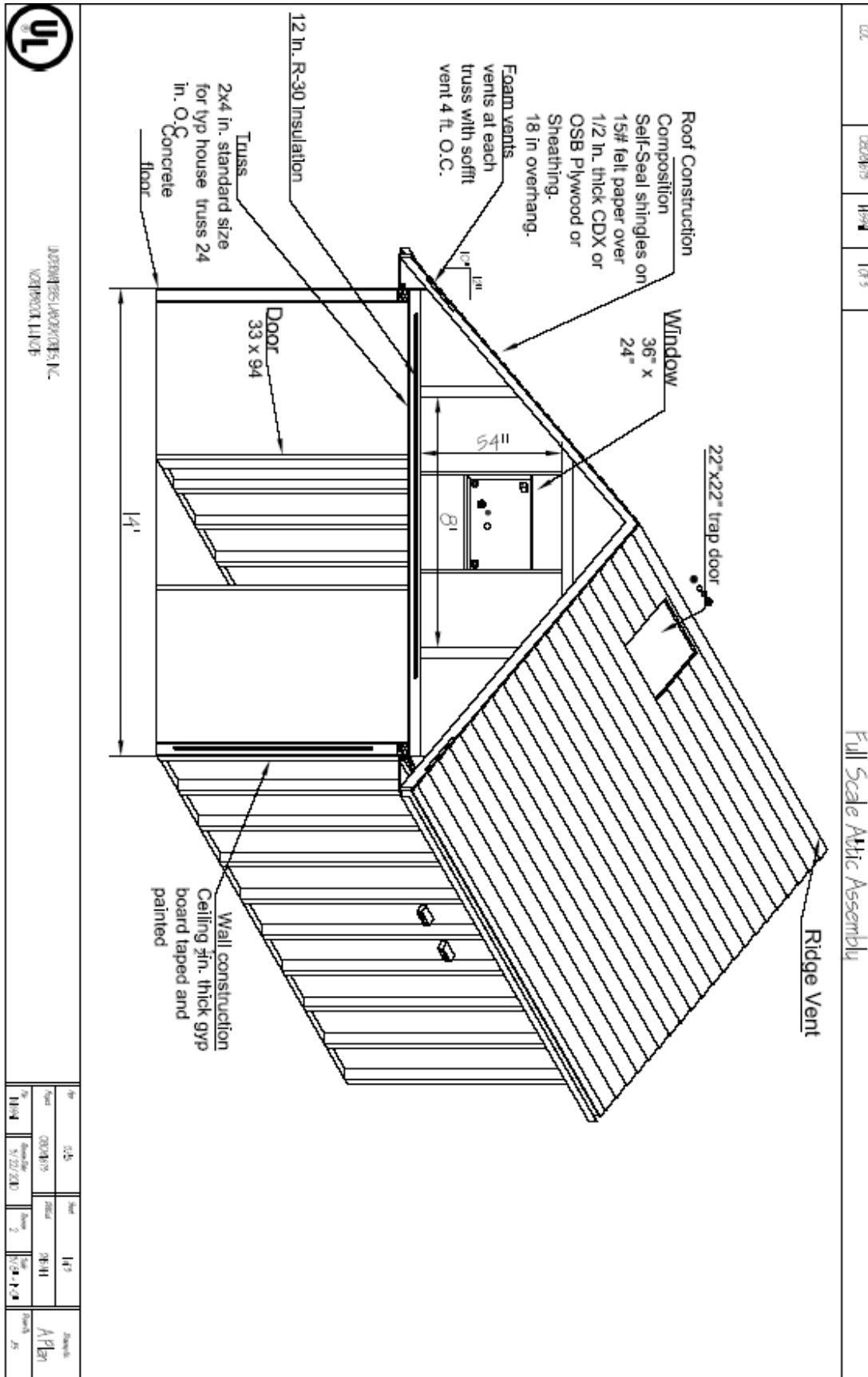


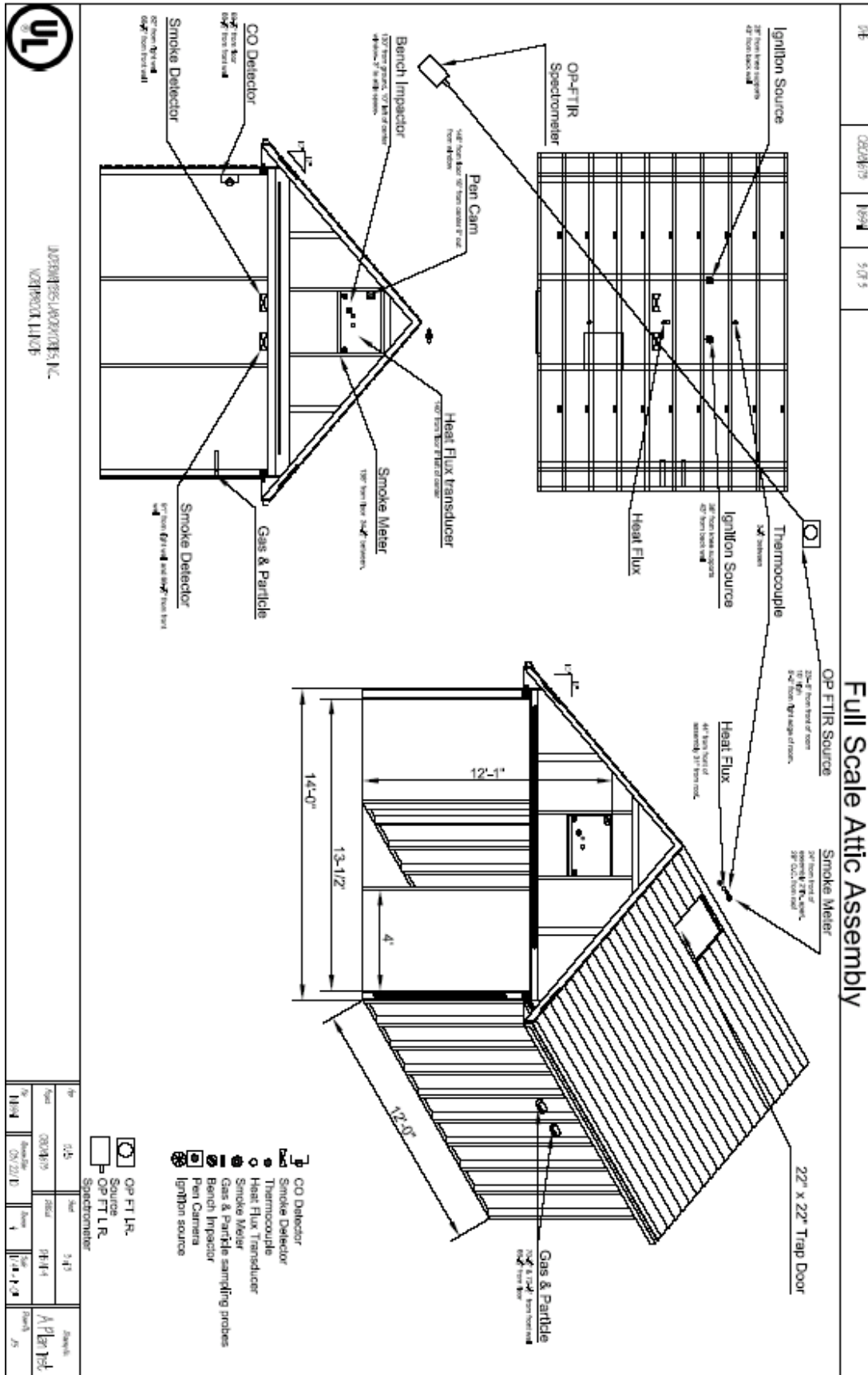


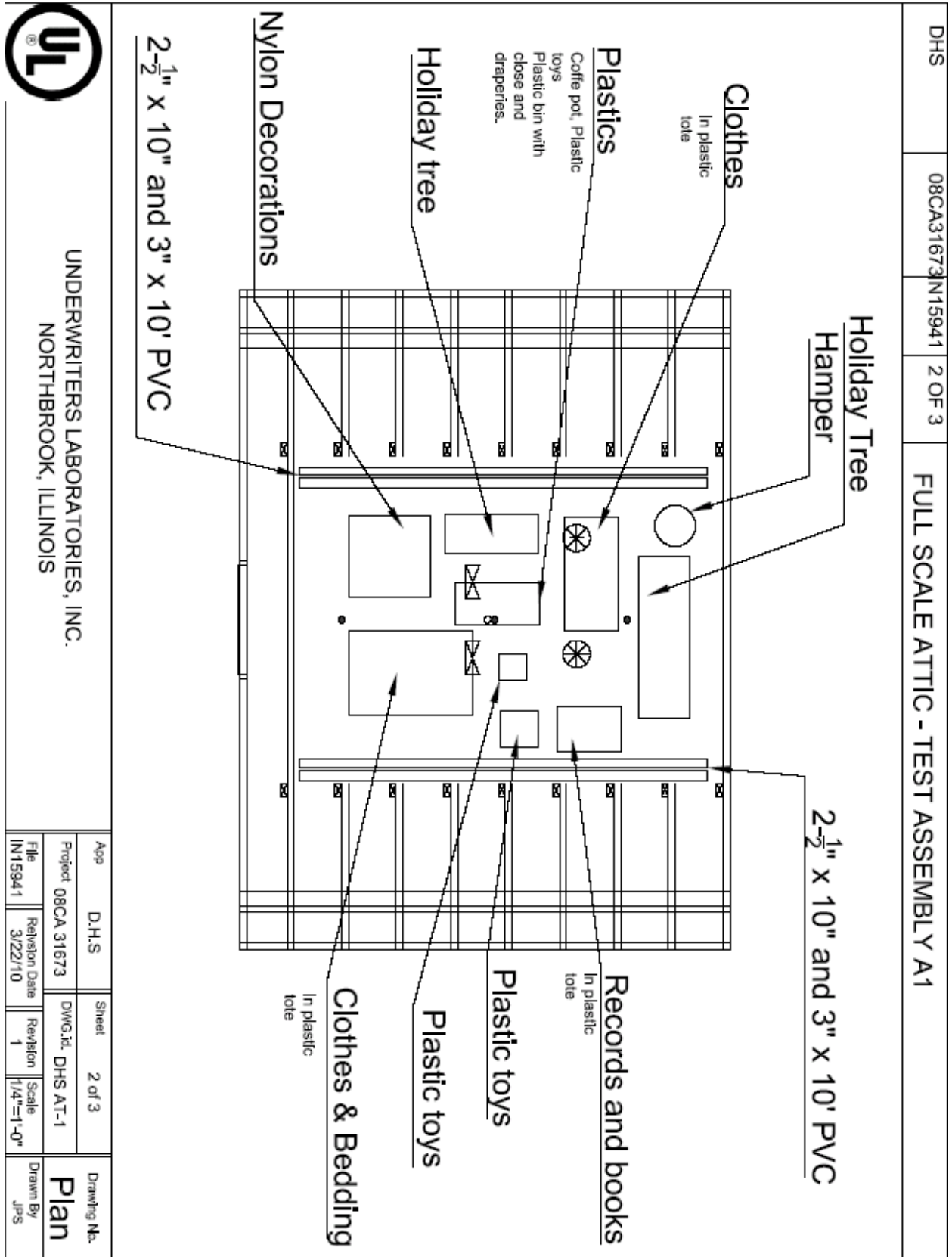




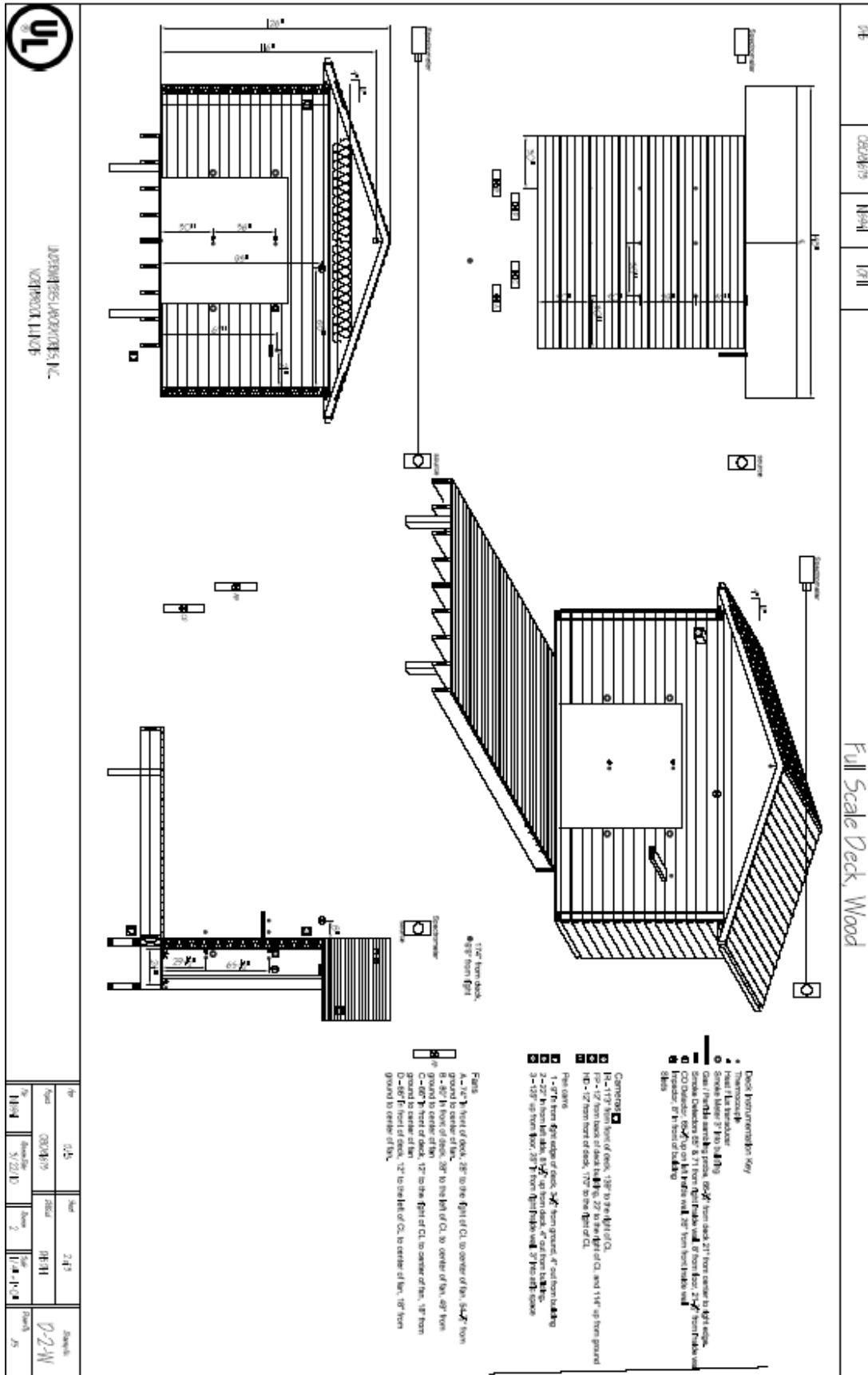


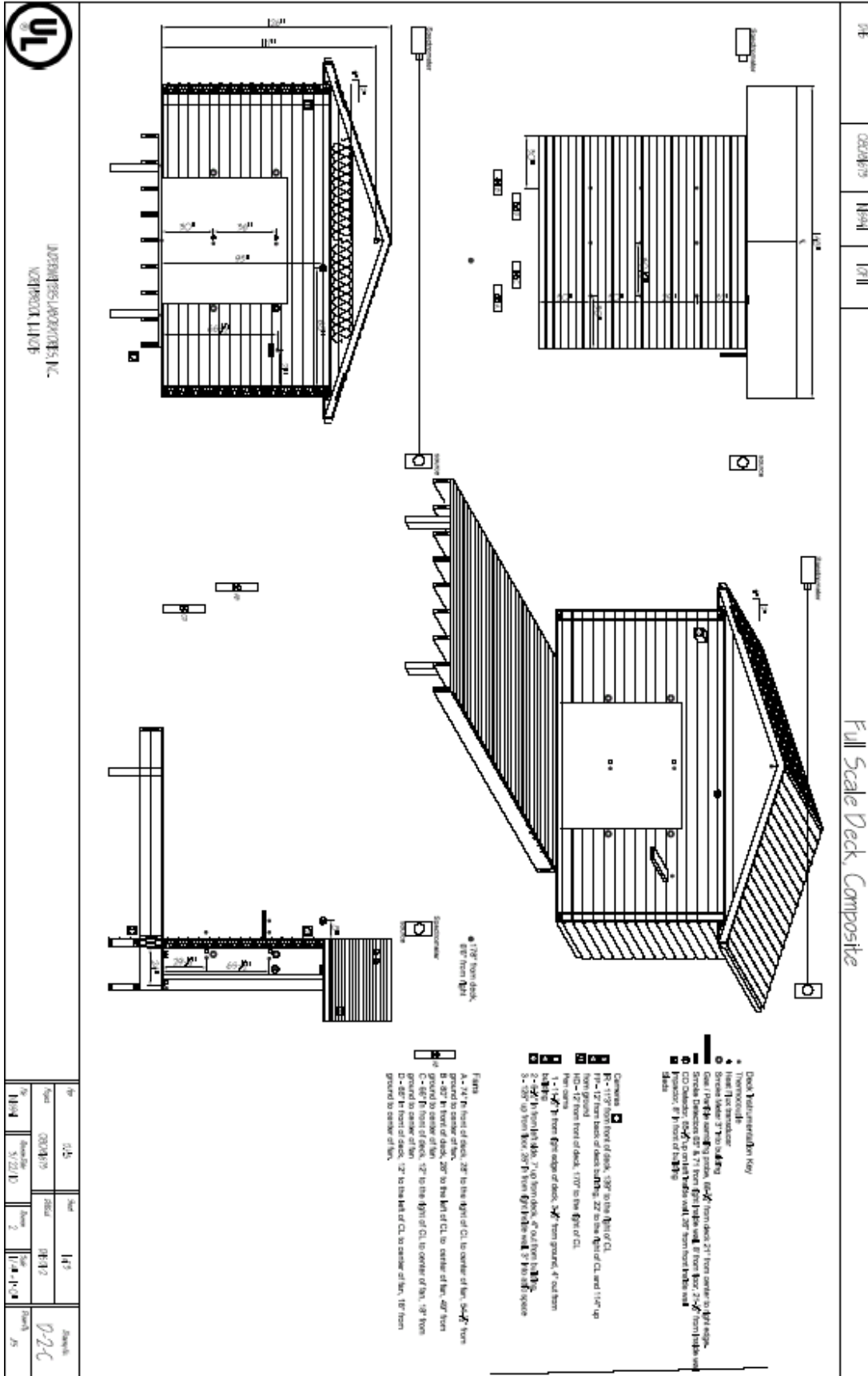


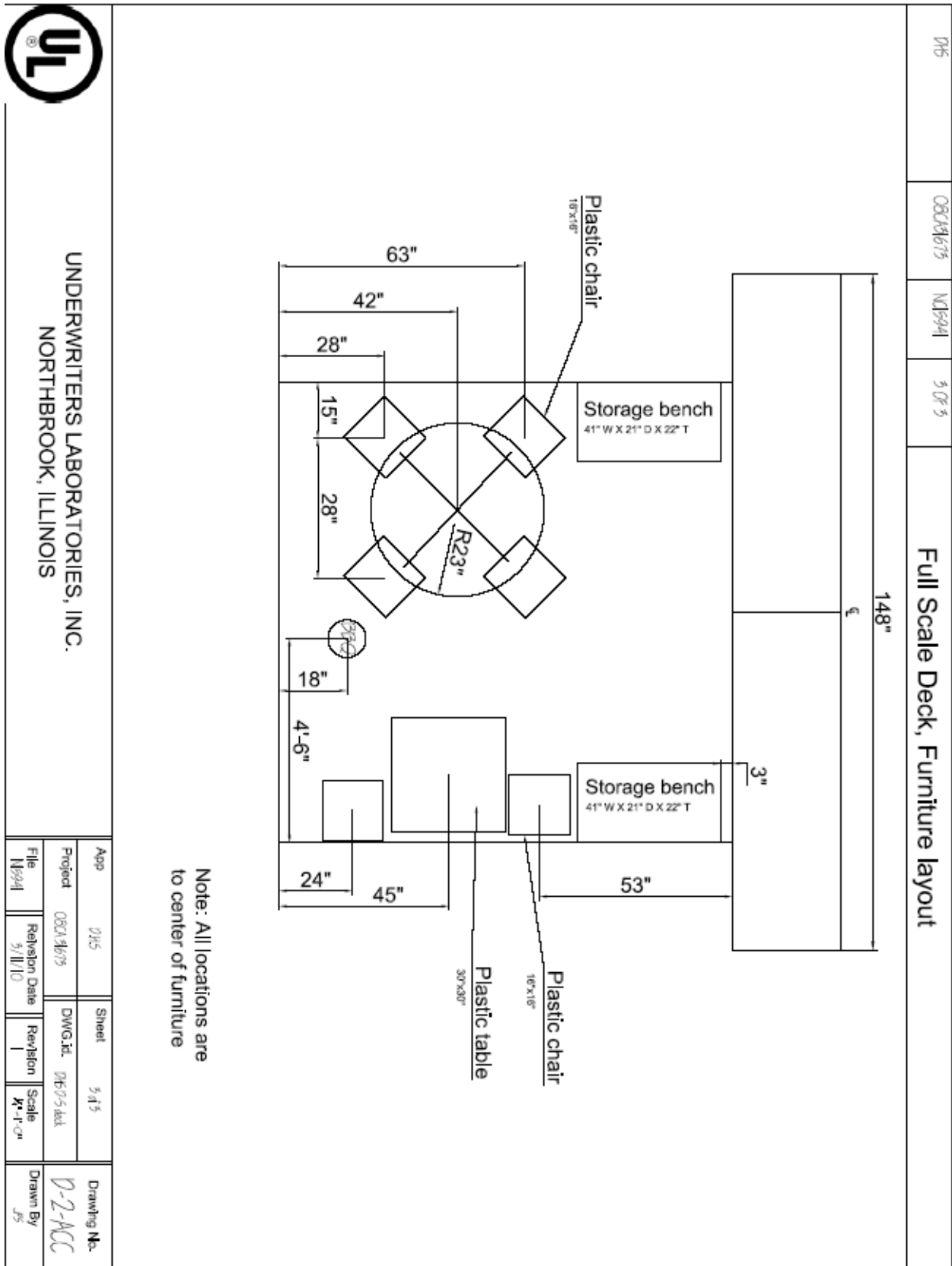




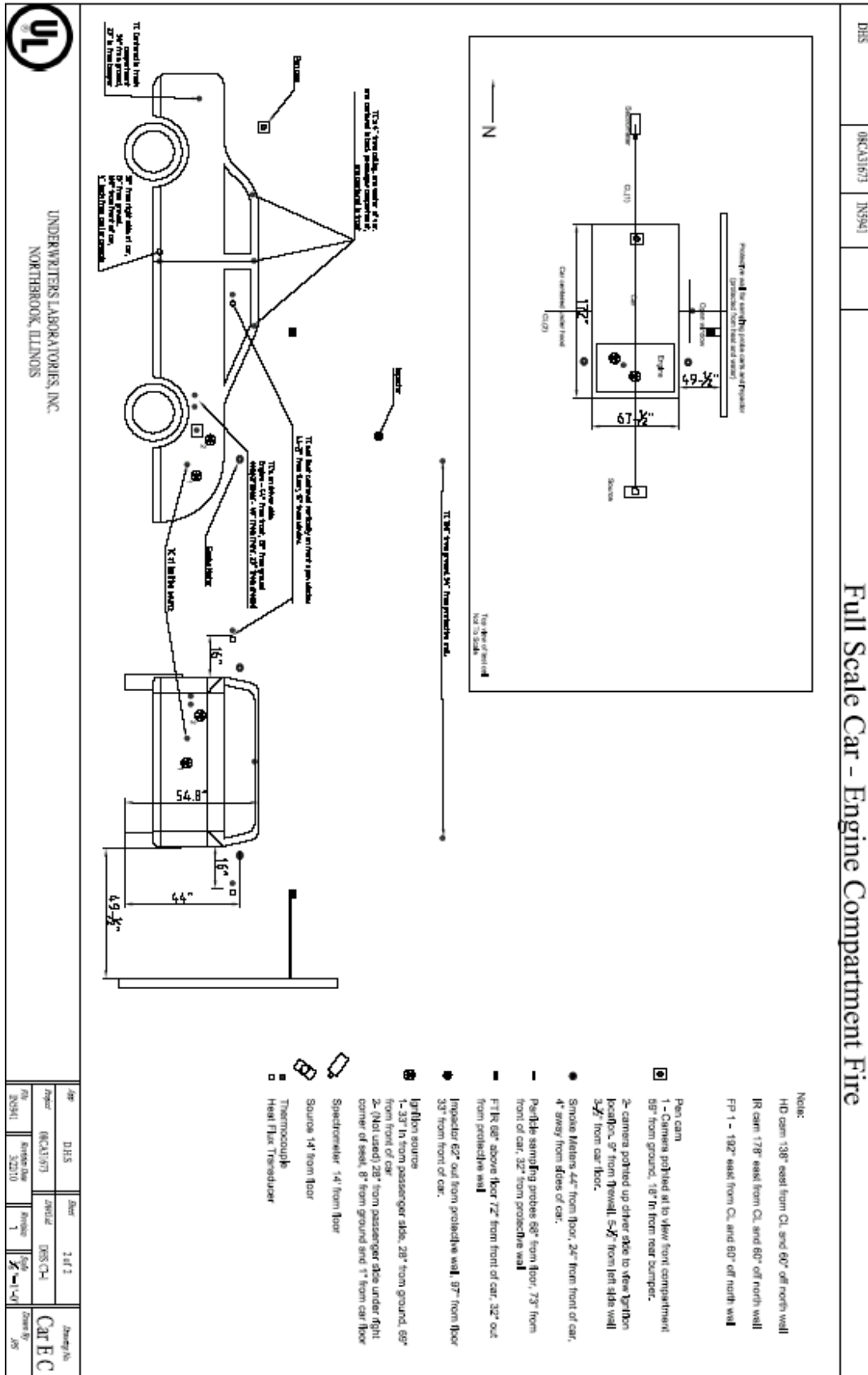












## APPENDIX C: LARGE-SCALE FIRE TEST SAMPLES

### C.0 OVERVIEW

This section provides a photographic documentation of representative samples that were used for the large-scale tests. The following sections, although not completely inclusion, provide a representative list of the types of fuel load that were used in the various fire tests. When possible, photographs are shown of the fuel load before and after the fire test. In several instances, however, the items were fully consumed and/or unrecoverable; therefore no photograph was taken after the fire test.

### C.1 LIVING ROOM FIRE



Couch or sofa



Couch or sofa (post fire)



Love seat



Love seat (post fire)



Coffee table



Coffee table (post fire)



End table and lamp



End table and lamp (post fire)



Television



Television (post fire)



TV stand



TV stand (post fire)

### C.2 LIMITED VENTILATION LIVING ROOM FIRE



Desk



Desk (post fire)



Coffee table



Coffee table (post fire)



Desk chair



Desk chair (post fire)



Computer



Computer (post fire)





End table



End table (post fire)



Love seat



Love seat (post fire)



Couch



Couch (post fire)



Plastic plant



Plastic plant (post fire)



Television



Television (post fire)



Television stand



Television stand (post fire)



Child's plastic toy



Child's plastic toy



Blanket



Throw rug

### C.3 BEDROOM FIRE



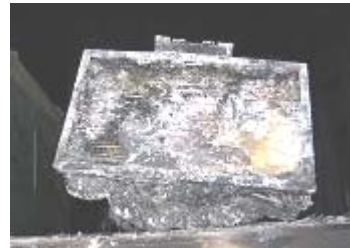
Dresser



Dresser (post fire)



Television



Television (post fire)



Dresser



Night stand

Dresser (post fire)



Night stand (post fire)



Mattress



Mattress (post fire)



Basket



Basket (post fire)



Bed frame



Bed frame (post fire)



Ceiling fan and light



Ceiling fan and light (post fire)

### C.4 KITCHEN FIRE



Refrigerator



Refrigerator (post fire)



Table



Table (post fire)



Household chemical



Household chemical (post fire)



Stove



Stove (post fire)



Chair



Chair (post fire)



Cabinet



Cabinet (post fire)



Drawer of utensils



Drawer of utensils (post fire)



Toaster



Toaster (post fire)



Cooking pot



Cooking pot (post fire)



Cook book



Cook book (post fire)

**C.5 ATTIC FIRE**



Child's toy



Child's toy (post fire)



Records



Records (post fire)



Holiday tree



Holiday tree (post fire)





Infant mattress



Infant mattress (post fire)



Child's toy



Child's toy (post fire)



Plastic container of clothes



Plastic container of clothes (post fire)

### C.6 WOOD DECK FIRE



Plastic sled



Plastic sled (post fire)



Umbrella



Siding



Plastic table



Plastic chair



Storage container



Wood decking

**C.7 COMPOSITE DECK FIRE**



Plastic table



Table



Plastic storage container



Composite decking



Umbrella



Siding



Seat cushion



Plastic sled

### C.8 AUTOMOBILE PASSENGER COMPARTMENT FIRE



Engine compartment



Engine compartment (post fire)



Rubber wheel



Rubber wheel (post fire)



Front seat



Front seat (post fire)



Trunk



Trunk (post fire)



Back seat



Back seat (post fire)

### C.9 AUTOMOBILE ENGINE COMPARTMENT FIRE



Engine compartment



Engine compartment (post fire)



Rubber tire



Rubber tire (post fire)



Passenger compartment



Passenger compartment (post fire)