

CLASS "A" CAR PROP
NDT TO SCALE

PROJECT NUMBER:	00-W-000	REVISION DATES
PROJECT ERECTOR:	JPK	1 1-24-13
DRAWN BY:	REP	2
REVIEWED BY:	REP	3
PRINT DATE:	12-26-12	4

CLASS "A" CAR PROP

THIS DRAWING IS THE PROPERTY OF TRAINING TOWERS, INC. AND IS NOT TO BE REPRODUCED OR TRANSMITTED IN ANY FORM OR BY ANY MEANS, ELECTRONIC OR MECHANICAL, INCLUDING PHOTOCOPYING, RECORDING, OR BY ANY INFORMATION STORAGE AND RETRIEVAL SYSTEM, WITHOUT THE WRITTEN PERMISSION OF TRAINING TOWERS, INC. THIS DRAWING IS THE PROPERTY OF TRAINING TOWERS, INC. AND IS NOT TO BE REPRODUCED OR TRANSMITTED IN ANY FORM OR BY ANY MEANS, ELECTRONIC OR MECHANICAL, INCLUDING PHOTOCOPYING, RECORDING, OR BY ANY INFORMATION STORAGE AND RETRIEVAL SYSTEM, WITHOUT THE WRITTEN PERMISSION OF TRAINING TOWERS, INC.

1ST ALARM - FOUR STORY
FIRE TRAINING SIMULATOR

FIRE DEPARTMENT TRAINING SIMULATOR



A DIV. OF J.S.C. INC

9121 BOND OVERLAND PARK, KS 66214
TEL: 913-385-3663 FAX: 913-385-7078
TOLL FREE 1-800-351-2525 www.trainingtowers.com

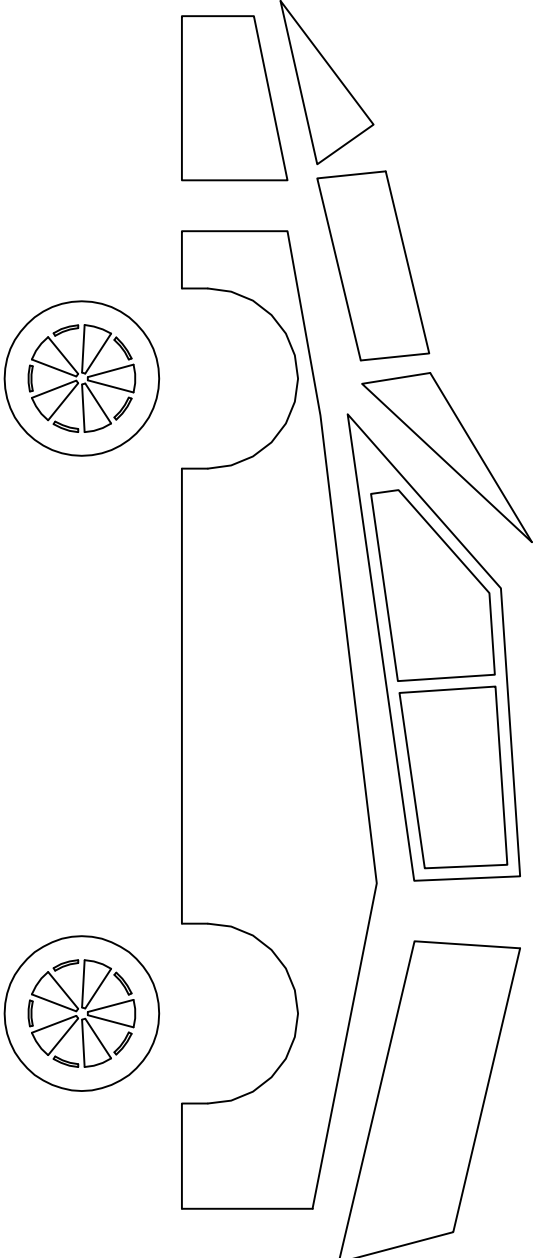
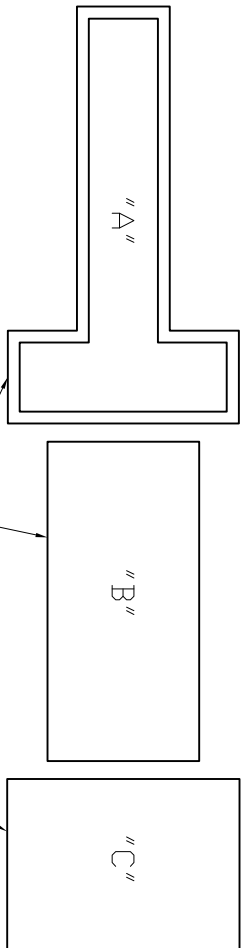
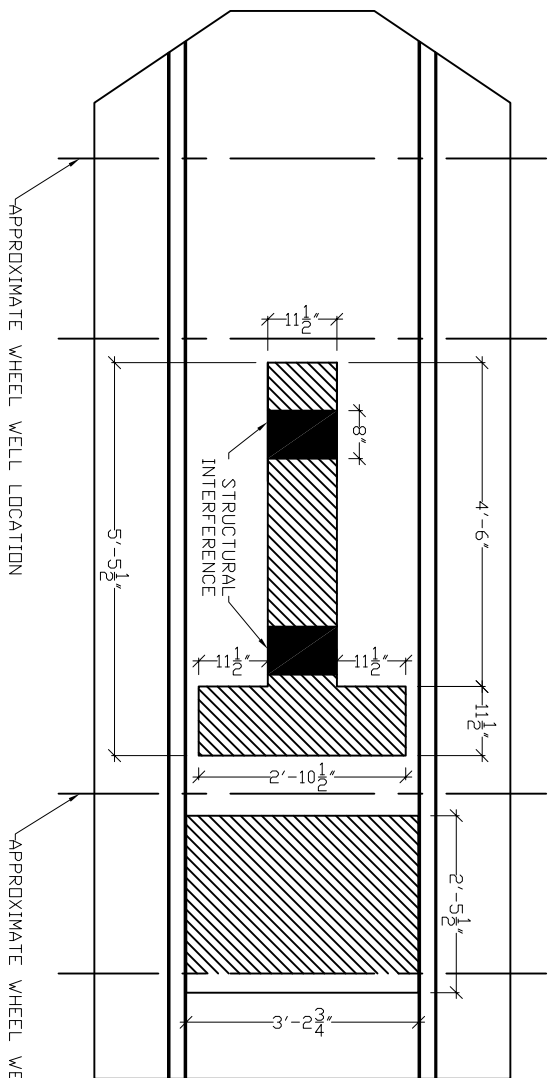
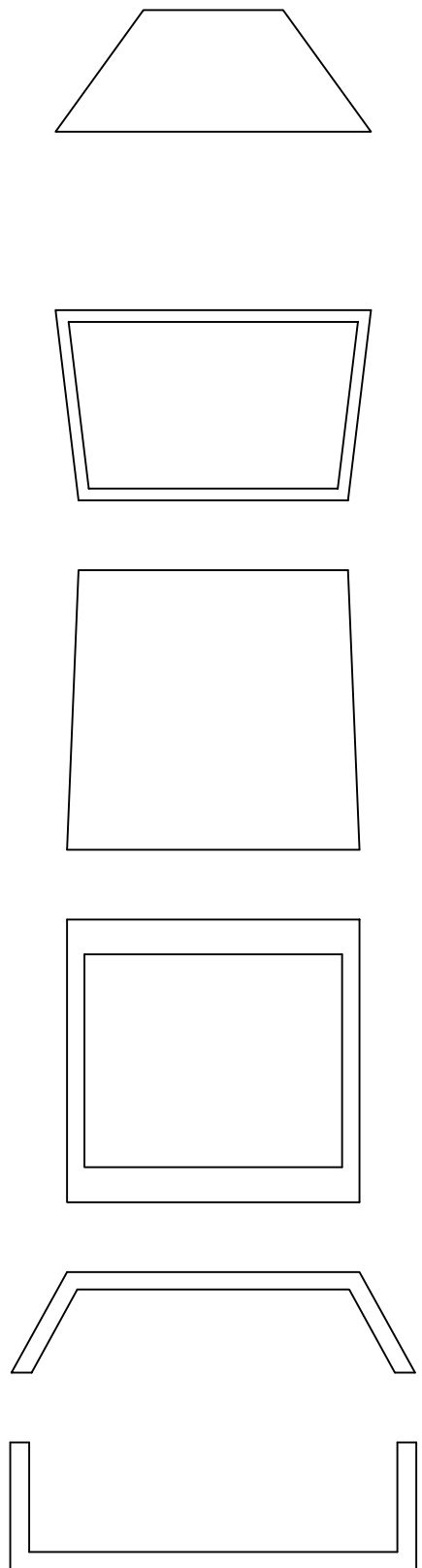

CLASS "A" CAR PROP EXPLODED PART DETAILS
NOT TO SCALE

PROJECT NUMBER:	00-W-000	REVISION DATES
PROJECT ERECTOR:		1
DRAWN BY:	JPK	2
REVIEWED BY:	REP	3
PRINT DATE:	1-24-13	4

CLASS "A" CAR PROP
EXPLODED COMPONENT DETAIL

THE INFORMATION CONTAINED ON THIS DRAWING IS THE PROPERTY OF TRAINING TOWERS, INC. AND IS TO BE USED ONLY FOR THE PROJECT AND SITE SPECIFICALLY IDENTIFIED HEREON. ANY REUSE OR MODIFICATION OF THIS DRAWING WITHOUT THE WRITTEN CONSENT OF TRAINING TOWERS, INC. IS STRICTLY PROHIBITED. THE USER OF THIS DRAWING SHALL BE RESPONSIBLE FOR OBTAINING ALL NECESSARY PERMITS AND APPROVALS FROM THE APPROPRIATE AGENCIES AND AUTHORITIES. TRAINING TOWERS, INC. SHALL NOT BE RESPONSIBLE FOR ANY DAMAGE TO PERSONS OR PROPERTY, INCLUDING CONSEQUENTIAL DAMAGES, ARISING FROM THE USE OF THIS DRAWING. THE USER OF THIS DRAWING SHALL BE RESPONSIBLE FOR OBTAINING ALL NECESSARY PERMITS AND APPROVALS FROM THE APPROPRIATE AGENCIES AND AUTHORITIES. TRAINING TOWERS, INC. SHALL NOT BE RESPONSIBLE FOR ANY DAMAGE TO PERSONS OR PROPERTY, INCLUDING CONSEQUENTIAL DAMAGES, ARISING FROM THE USE OF THIS DRAWING.

**1ST ALARM - FOUR STORY
FIRE TRAINING SIMULATOR**

FIRE DEPARTMENT TRAINING SIMULATOR

w|h|p trainingtowers.com

A DIV. OF J.S.C. INC

9121 BOND OVERLAND PARK, KS 66214
TEL: 913-385-3663 FAX: 913-385-7078
TOLL FREE 1-800-351-2525 www.trainingtowers.com

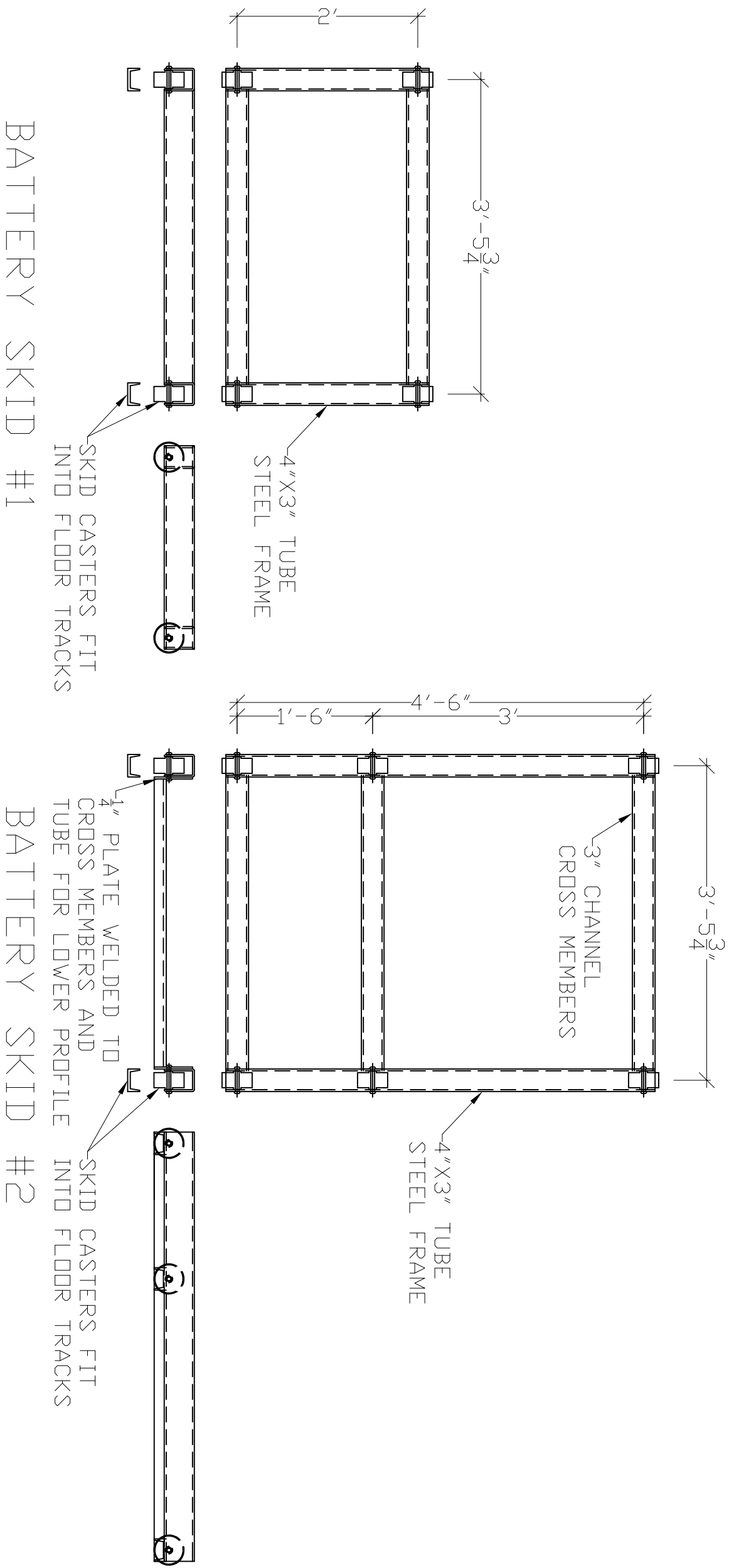

PROJECT NUMBER:	00-W-000	REVISION DATES
PROJECT ERECTOR:		1 1-24-13
DRAWN BY:	JPK	2
REVIEWED BY:	REP	3
PRINT DATE:	12-26-12	4

CLASS "A" CAR PROP

THESE DRAWINGS, SPECIFICATIONS, NOTES, SCHEDULES, AND DIMENSIONS ARE THE PROPERTY OF TRAINING TOWERS, INC. AND ARE TO BE USED ONLY FOR THE PROJECT AND SITE SPECIFICALLY IDENTIFIED HEREIN. ANY REUSE OR MODIFICATION OF THESE DRAWINGS WITHOUT THE WRITTEN CONSENT OF TRAINING TOWERS, INC. IS STRICTLY PROHIBITED.

THE SET OF DRAWINGS IS INTENDED AS A COMPLETE SET. ANY OMISSIONS OR INCONSISTENCIES SHALL BE THE RESPONSIBILITY OF THE USER. THE USER SHALL VERIFY ALL DIMENSIONS AND CONDITIONS BEFORE CONSTRUCTION.

THESE DRAWINGS ARE THE PROPERTY OF TRAINING TOWERS, INC. AND ARE TO BE USED ONLY FOR THE PROJECT AND SITE SPECIFICALLY IDENTIFIED HEREIN. ANY REUSE OR MODIFICATION OF THESE DRAWINGS WITHOUT THE WRITTEN CONSENT OF TRAINING TOWERS, INC. IS STRICTLY PROHIBITED.

**1ST ALARM - FOUR STORY
FIRE TRAINING SIMULATOR**

FIRE DEPARTMENT TRAINING SIMULATOR

w|h|p trainingtowers.com

A DIV. OF J.S.C. INC

9121 BOND OVERLAND PARK, KS 66214
 TEL: 913-385-3663 FAX: 913-385-7078
 TOLL FREE 1-800-351-2525 www.trainingtowers.com



Microbac Laboratories, Inc.
Baltimore Division
2101 Van Deman Street • Baltimore, MD 21224

Phone: 410-633-1800
Fax: 410-633-6553
www.microbac.com

COVER LETTER

Ben Cottis
Exponent
4901 Telsa Drvie Suite L
Bowie, MD 20715
RE: General Analysis

April 23, 2013
Report No.: 13D1376

The report of analyses contains test results for samples received at Microbac Laboratories, Inc., Baltimore Division on 04/17/2013 12:20.

The enclosed results were obtained from and applicable to the sample(s) as received at the laboratory. All sample results are reported on an "as received" basis unless otherwise noted.

All data included in this report has been reviewed and meet the applicable project and certification specific requirements, unless otherwise noted.

This report has been paginated in its entirety and shall not be reproduced except in full, without the written approval of Microbac Laboratories, Inc.

We appreciate the opportunity to service your analytical needs. If you have any questions, please feel free to contact us.

This Data Package contains the following:

- This Cover Page
- Sample Summary
- Test Results
- Certifications/Notes and Definitions
- Cooler Receipt Log
- Chain of Custody

A blue ink signature of Mark B. Horan, written in a cursive style, positioned above a horizontal line.

4/23/2013

Final report reviewed by:

Mark B. Horan/Laboratory Director

Report issue date

All samples received in proper condition and results conform to ISO 17025 and TNI NELAC standards unless otherwise noted.

If we have not met or exceeded your expectations, please contact Mark Horan, Managing Director, at 410-633-1800 You may also contact Sean Hyde, Chief Operating Officer at sean.hyde@microbac.com or James Nokes, President james.nokes@microbac.com



Microbac Laboratories, Inc.

Baltimore Division

2101 Van Deman Street • Baltimore, MD 21224

Phone: 410-633-1800

Fax: 410-633-6553

www.microbac.com

CERTIFICATE OF ANALYSIS

Exponent 4901 Telsa Drvie Suite L Bowie, MD 20715	Project: General Analysis Project Number: FPRF Response, 1205174.000 Project Manager: Ben Cotts	Report: 13D1376 Reported: 04/23/2013 13:38
---	---	---

SAMPLE SUMMARY

Sample ID	Laboratory ID	Matrix	Type	Date Sampled	Date Received
Control Water Sample	13D1376-01	Water	Not Specified	03/27/2013 15:00	04/17/2013 12:20

Microbac Laboratories, Inc., Baltimore Division

The results in this report apply to the samples analyzed in accordance with the chain of custody document. This analytical report must be reproduced in its entirety.

Mark B. Horan, Laboratory Director

Original Lab Report



Microbac Laboratories, Inc.

Baltimore Division

2101 Van Deman Street • Baltimore, MD 21224

Phone: 410-633-1800

Fax: 410-633-6553

www.microbac.com

CERTIFICATE OF ANALYSIS

Exponent 4901 Telsa Drvie Suite L Bowie, MD 20715	Project: General Analysis Project Number: FPRF Response, 1205174.000 Project Manager: Ben Cotts	Report: 13D1376 Reported: 04/23/2013 13:38
---	---	---

Control Water Sample

13D1376-01 (Water) Sampled: 03/27/2013 15:00; Type: Not Specified

Analyte	Result	Reporting		Units	Prepared	Analyzed	Analyst	Method	Notes
		Limit							

Microbac Laboratories, Inc., Baltimore Division

Wet Chemistry

Conductivity	190	10	umhos/cm	042213 1010	042213 1010	VAS	SM (20) 2510B
--------------	-----	----	----------	-------------	-------------	-----	---------------

Microbac Laboratories, Inc., Baltimore Division

The results in this report apply to the samples analyzed in accordance with the chain of custody document. This analytical report must be reproduced in its entirety.

Mark B. Horan, Laboratory Director

Original Lab Report



Microbac Laboratories, Inc.

Baltimore Division

2101 Van Deman Street • Baltimore, MD 21224

Phone: 410-633-1800

Fax: 410-633-6553

www.microbac.com

CERTIFICATE OF ANALYSIS

Exponent 4901 Telsa Drvie Suite L Bowie, MD 20715	Project: General Analysis Project Number: FPRF Response, 1205174.000 Project Manager: Ben Cottis	Report: 13D1376 Reported: 04/23/2013 13:38
---	--	---

Project Requested Certification(s):

State of Pennsylvania (NELAC)

Analyte Certification Exception Summary

No certification exceptions

All analysis performed were analyzed under the required certification unless otherwise noted in the above summary.

Certification List

Below is a list of certifications maintained by Microbac Laboratories, Inc. All data included in this report has been reviewed for and meets all project specific and quality control requirements of the applicable accreditation, unless otherwise noted. A complete list of individual analytes pursuant to each certification below is available upon request.

Code	Description	Certification Number	Expires
Microbac Laboratories, Inc., Baltimore Division			
A2LA1	A2LA (Biology)	410.02	04/30/2013
A2LA2	A2LA (Environmental)	410.01	04/30/2013
VA-B	Commonwealth of Virginia (NELAC) - Baltimore	460170-1829	06/14/2013
CPSC	CPSC Testing of Childrens Products and Jewelry	1115	04/30/2013
Pb	Environmental Lead (ELLAP)	410.01	04/30/2013
NJ	New Jersey	NLC120001	06/30/2013
MD	State of Maryland (Drinking Water)	109	06/30/2013
PA	State of Pennsylvania (NELAC)	68-00339	08/31/2013
USDA	US Department of Agriculture	P330-09-00021	02/19/2012
WV	West Virginia	054	08/31/2013
Microbac Laboratories, Inc., Richmond Division			
VA-R	Commonwealth of Virginia (NELAC) - Richmond	460022-1834	06/14/2013

Microbac Laboratories, Inc., Baltimore Division

The results in this report apply to the samples analyzed in accordance with the chain of custody document. This analytical report must be reproduced in its entirety.

Mark B. Horan, Laboratory Director

Original Lab Report



Microbac Laboratories, Inc.

Baltimore Division

2101 Van Deman Street • Baltimore, MD 21224

Phone: 410-633-1800

Fax: 410-633-6553

www.microbac.com

CERTIFICATE OF ANALYSIS

Exponent
4901 Telsa Drvie Suite L
Bowie, MD 20715

Project: General Analysis
Project Number: FPRF Response, 1205174.000
Project Manager: Ben Cotts

Report: 13D1376
Reported: 04/23/2013 13:38

Qualifiers/Notes and Definitions

General Definitions:

DET Analyte DETECTED
ND Analyte NOT DETECTED at or above the reporting limit
dry Sample results reported on a dry weight basis
RPD Relative Percent Difference



Microbac Laboratories, Inc.
Baltimore Division
2101 Van Deman Street • Baltimore, MD 21224

Phone: 410-633-1800
Fax: 410-633-6553
www.microbac.com

Cooler Receipt Log

Cooler ID: Default Cooler	Cooler Temp: 23.20 °C	Work Order: 13D1376
Custody Seals Intact: Yes	COC/Containers Agree: Yes	
Containers Intact: Yes	Correct Preservation: Yes	
Received On Ice: Yes	Correct Number of Containers Received: Yes	
Radiation Scan Acceptable: Yes	Sufficient Sample Volume for Testing: Yes	
COC Present: Yes	Samples Received in Proper Condition: Yes	

Comments:



Microbac Laboratories Inc., Baltimore Division

2101 Van Deman St, Baltimore, MD 21224

Tel: 410-633-1800

Fax: 410-633-6553

www.microbac.com

Instructions for completing the Chain of Custody Record on back.

Chain of Custody Record

Customer Name: Benjamin Cotts, Address: 17000 Science Drive, Suite 200, Bowie, MD 20715

Project Manager Name: Andrew Blum, Phone: (301) 291-2515, Email: ablum@exponent.com

Turn Around Time: Normal (selected), RUSH*, Needed By: []

Compliance: Yes, No (selected), Agency: []

QC Level: I (selected), II**, III**, IV**

Project Information Name: FPRF Response, Number: 1205174.000, PO: []

Sampler Name: [], Phone: [], Cert ID:*** []

Report Options: EDD [], Email: ablum@exponent.com (checked), Fax []



Table with columns: Client Sample ID, Matrix****, Grab, Composite, Filtered, Date Collected, Time Collected, No. of Containers, Water Conductivity, Requested Analysis, Comments. Row 1: Control Water Sample, 03/27/13, 15:00, 1, [checkmark]

Possible Hazard Identification: Hazardous [], Non-Hazardous (selected), Radioactive [] Sample Disposition: Dispose as appropriate (selected), Return [], Archive []

Table with columns: Number of Containers, Cooler Number, Sampled By (signature), Relinquished By (signature), Printed Name/Affiliation, Date/Time, Received By (signature), Printed Name/Affiliation. Includes handwritten signatures and dates like 4/11/2013 and 4/17/13/22.

* Please notify lab prior to drop off. ** Surcharge May Apply to add'l QC Packages *** Sampler certification ID needed for some agencies. Page 1 of 2 rev.121112

**** Matrix Types: Air(A), Childrens Product(CP), Food(F), Paint(P), Soil/Solid (S), Oil(O), Wipe(WI), Drinking Water (DW), Groundwater (GW), Surface Water (SW), Waste Water (WW), Other (specify)

MATERIALS CHARACTERIZATION REPORT

Report No.: 1304.17 **Date:** April 15, 2013

Customer: Elizabeth Keller
Exponent
17000 Science Drive
Bowie, MD 20715

Customer P.O.: 1205174

Samples: Three Aqueous Samples

- Control 3/27/13
- Test 3 3/28/13
- Test 6 4/3/13

Objective: Determine and Compare the pH, Total Organic, Total Inorganic Carbon, Chloride, Fluoride and the Metals Concentrations of the Three Aqueous Solutions

SUMMARY

The pH and elemental analysis results found for the three aqueous solutions are listed in the Summary Table.

Summary Table

Element/Assay	Concentration (ppm)		
	Control	Test 3	Test 6
pH	7.82	6.18	7.31
Total Organic C	1.3	150	360
Total Inorganic C	7.3	7.7	21
Chloride	34	143	60
Fluoride	0.7	27	33
Li	< 0.005	0.25	3.60
P	< 1.0	7.5	11
Ca	23	72	42
Na	13	19	17
Mg	4.8	6.9	7.0
K	2.4	6.0	4.8
Sr	0.08	4.5	0.44
Al	0.01	3.0	1.0
Fe	0.09	0.72	0.17
Ba	0.02	0.61	0.27
B	0.01	0.05	1.8
Zn	< 0.005	29.0	2.7
Mn	< 0.005	0.27	4.6
Sb	< 0.002	0.70	0.70
Ni	< 0.010	0.05	0.69
Co	< 0.005	0.02	0.76
Cu	< 0.005	0.15	0.14
As	< 0.010	< 0.010	< 0.010
V	< 0.002	0.002	0.003

The majority of elemental concentrations have been rounded to two significant figures to simplify the comparison. All solids were filtered from the solution before analyses of the filtrate. And are not included these results.

The elements are grouped as carbon, chloride/fluoride anion (not total Cl/F), lithium/phosphorus and roughly descending amounts of the metals.

Only the Test 3 solution exhibits a slightly acidic pH (6.2) value. While it is possible that the low levels of chloride (143 ppm) and fluoride (27 ppm) might have been initially present as HCl and

INTRODUCTION

Three aqueous samples, identified as Control 3/27/13, Test 3 3/28/13 and Test 6 4/3/13, were received from E Keller on April 9th.

The objective is to determine and compare the pH, total organic, total inorganic carbon, chloride, fluoride and the metals concentrations of the three aqueous solutions.

ANALYSIS

Sample Preparation. The samples were delivered in glass bottles. The Control is clear, colorless solution while Test 3 and Test 6 have a significant loading of dark particulates. All samples were filtered prior to analyses.

pH. Measurements for pH were obtained with a Fisher Scientific Accumet Excel XL15 pH meter. Samples were filtered prior to analysis. Samples were then stirred for at least one minute before the measurement. A 7.00 pH buffer standard was measured with the samples. A value of 6.99 was obtained. The pH results are listed in the Summary Table.

Ion Chromatography (IC). IC is a very effective and sensitive method for the screening and routine analysis of many cations and anions in aqueous solutions. This well-known liquid chromatographic technique separates analytes according to their affinity for the separation column packed with an ion-exchange resin of low capacity. During the analysis, the effluent from the separation column is passed through a suppressor column to neutralize the counter-ions of the eluent and thus lower its conductivity. With the high background conductivity reduced, the sample ions are detected with high sensitivity (ppb range) using conductivity detection. The separated ions are identified qualitatively based on their relative retention times within the column and quantitatively through integration of signal intensity, which is proportional to the analyte concentration.

Instrumentation. All analyses were performed in duplicate using a Dionex ICS-2000 Ion Chromatograph under the following conditions:

<i>Anions:</i>	Column:	IonPac [®] AS9-HC + IonPac [®] AG9-HC
	Eluent:	9.0 mM Sodium carbonate
	Flow rate:	1.0 mL/min
	Detection:	Suppressed Conductivity ASRS [®] 300, AutoSuppression [™] Recycle Mode
	Injection volume:	250 μ L

Samples were diluted 2X to nearly 1000X with deionized water. A 0.2530 ppm anion standard run with the samples and met quality control parameters of $\pm 10\%$ (100-106% recovery). All individual chromatograms are collected in the IC Appendix. The sample data is collected in Table I and the final results listed in the Summary Table.

Table I – Sample Data Analyses

Analyte	Run 1	Run 2	Average	Dilution	Total (ppm)
<u>Control</u>					
Fluoride	0.3287	0.3352	0.3320	2.060	0.6838
Chloride	0.1703	0.1741	0.1722	199.6	34.37
<u>Test 3</u>					
Fluoride	0.2748	0.2713	0.2731	98.27	26.83
Chloride	0.1510	0.1570	0.1540	930.7	143.3
<u>Test 6</u>					
Fluoride	0.3707	0.3701	0.3704	88.46	32.76
Chloride	0.0758	0.0713	0.0736	813.4	59.83

Elemental Analyses. The ICP-MS/AES survey and total organic and inorganic carbon were performed by AnalysisNow! (Chandler, AZ). All samples were filtered prior to analysis. The

The AnalysisNow! reports are included in the Elemental Analysis Appendix.

The concentrations of only the detected elements expressed in ppm are listed in the Summary Table. No detectable amounts (> 0.002 to 0.010 ppm) of the following elements were present in any of the samples: Be, Ti, Cr, Ga, Ge, Zr, Nb, Mo, Ag, Cd, Sn, Ta, W, Au, Tl, Pb, Bi, Th and U.

As questions arise during your review of this report, please do not hesitate to call us.

ANALYZE Inc.



David De La Cruz
Consulting Chemist & Operations Manager



Steven J. Valenty, Ph.D.
Consulting Chemist & President

APPENDIX

Ion Chromatography

CALIBRATION CURVES

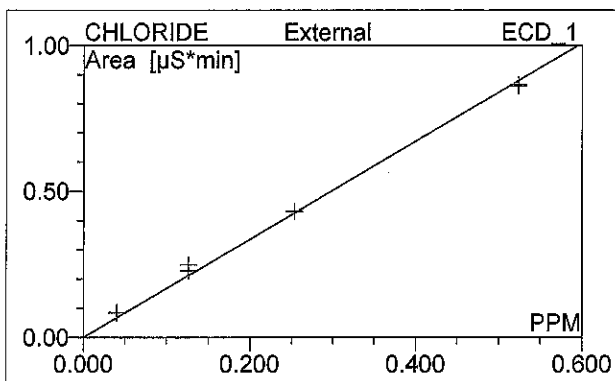
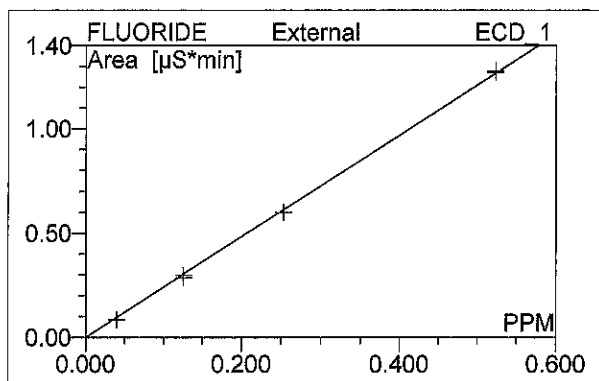

No.	Ret.Time min	Peak Name	Cal.Type	Points	Corr.Coeff. %	Offset	Slope	Curve
1	4.08	FLUORIDE	Lin	8	99.9926	0.0000	2.4233	0.0000
2	6.19	CHLORIDE	Lin	8	99.9627	0.0000	1.6806	0.0000
Average:					99.9777	0.0000	2.0520	0.0000

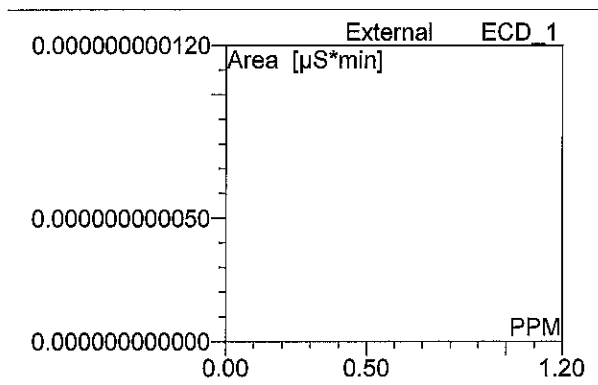
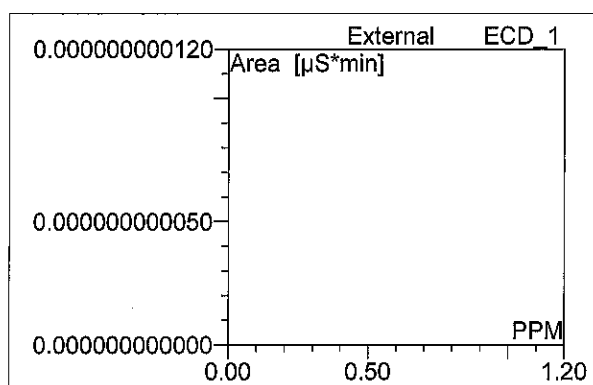
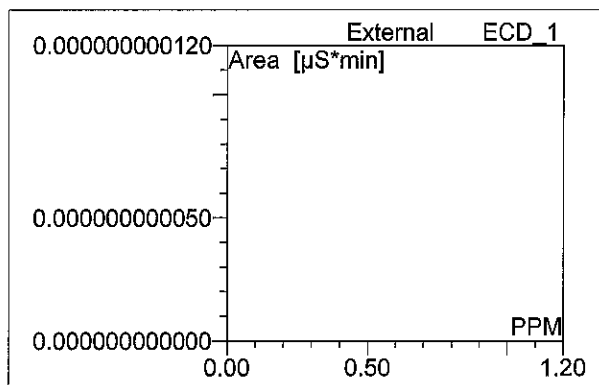

22 BLANK

Sample Name:	BLANK	Injection Volume:	250.0
Vial Number:	0	Channel:	ECD_1
Sample Type:	blank	Wavelength:	n.a.
Control Program:	Anions 2000	Bandwidth:	n.a.
Quantif. Method:	Anions 2000	Dilution Factor:	1.0000
Recording Time:	4/12/2013 9:43	Sample Weight:	1.0000
Run Time (min):	25.00	Sample Amount:	1.0000

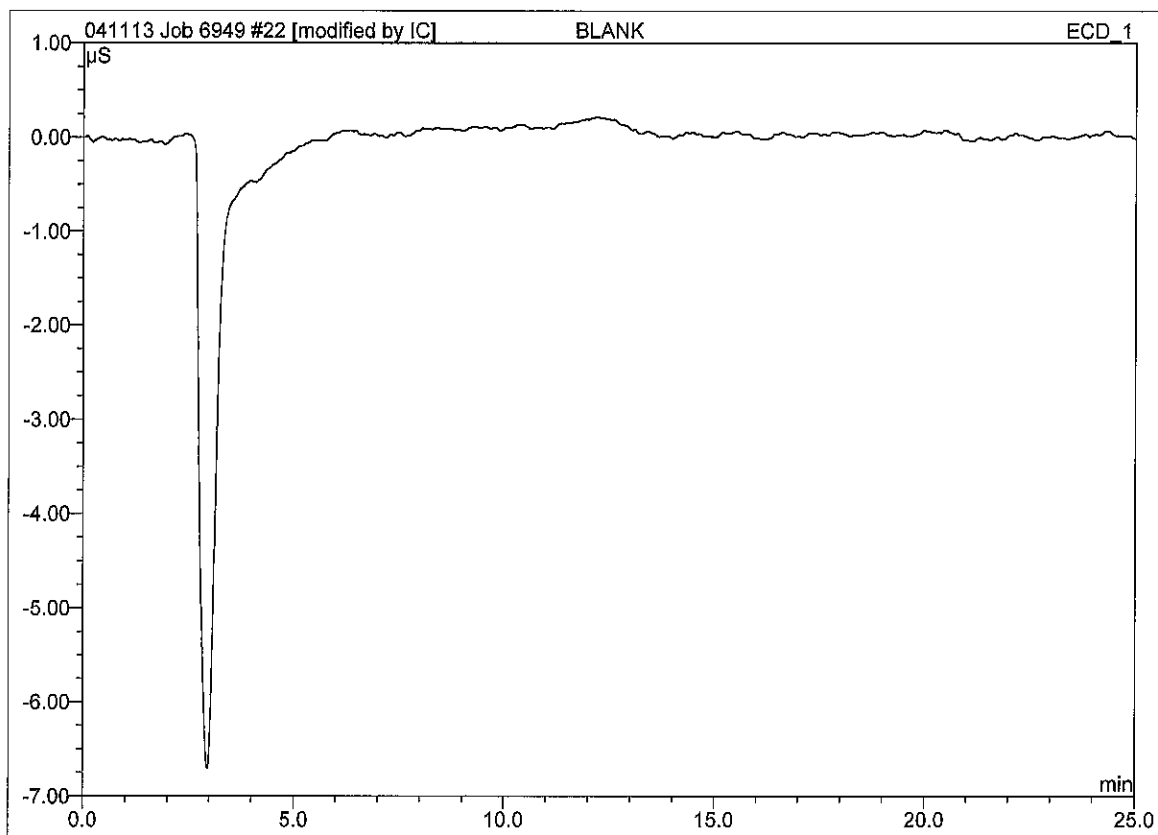

No.	Ret.Time min	Peak Name	Height μS	Area μS*min	Rel.Area %	Amount PPM	Type
-----	-----------------	-----------	--------------	----------------	---------------	---------------	------

23 BLANK	
Sample Name: BLANK	Injection Volume: 250.0
Vial Number: 0	Channel: ECD_1
Sample Type: blank	Wavelength: n.a.
Control Program: Anions 2000	Bandwidth: n.a.
Quantif. Method: Anions 2000	Dilution Factor: 1.0000
Recording Time: 4/12/2013 10:11	Sample Weight: 1.0000
Run Time (min): 25.00	Sample Amount: 1.0000

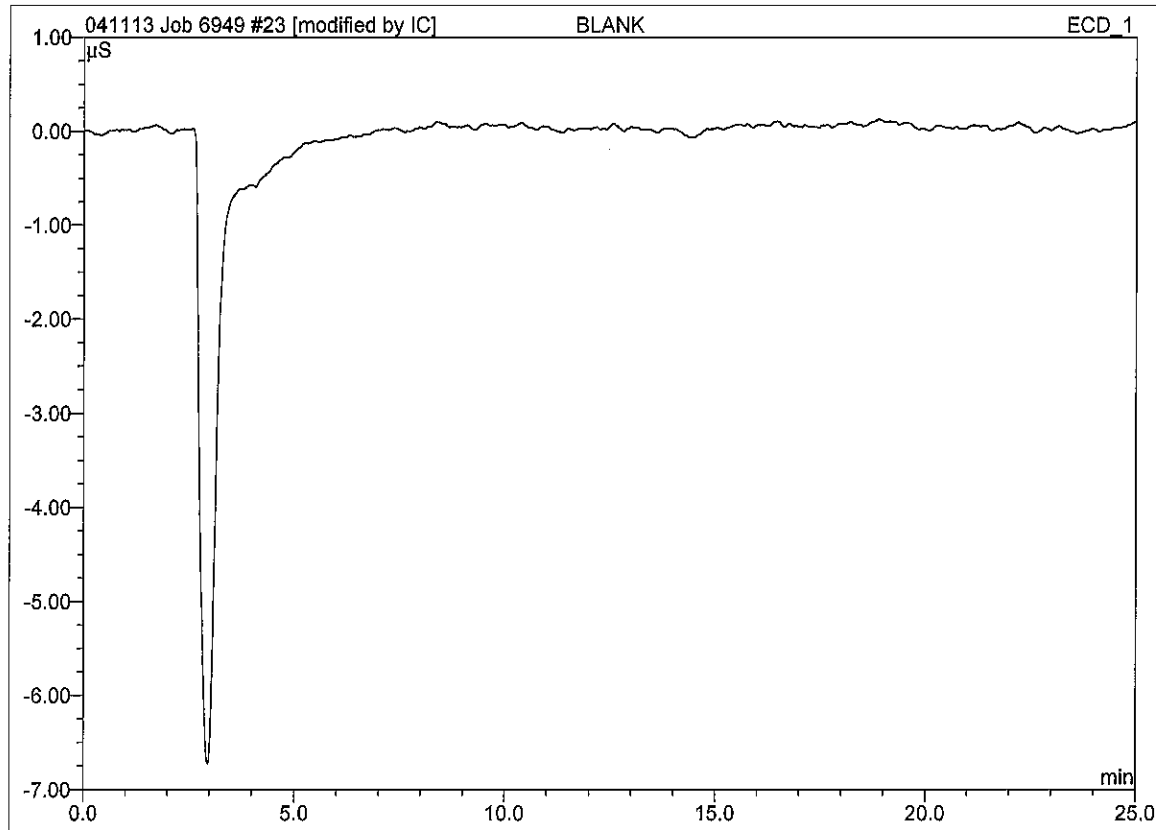

No.	Ret.Time min	Peak Name	Height μS	Area μS*min	Rel.Area %	Amount PPM	Type
-----	-----------------	-----------	--------------	----------------	---------------	---------------	------

20 0.25 PPM CHECK STD			
Sample Name:	0.25 PPM CHECK STD	Injection Volume:	250.0
Vial Number:	0	Channel:	ECD_1
Sample Type:	unknown	Wavelength:	n.a.
Control Program:	Anions 2000	Bandwidth:	n.a.
Quantif. Method:	Anions 2000	Dilution Factor:	1.0000
Recording Time:	4/11/2013 20:44	Sample Weight:	1.0000
Run Time (min):	25.00	Sample Amount:	1.0000

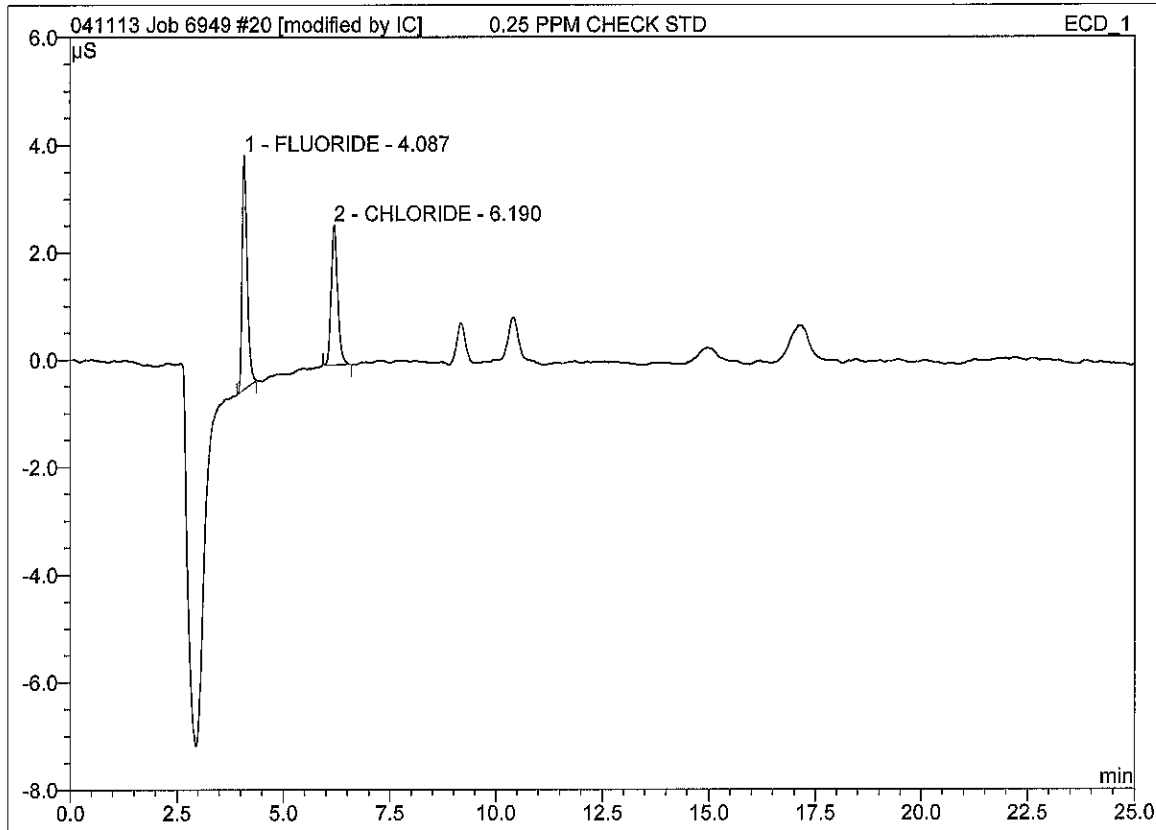

No.	Ret.Time min	Peak Name	Height μS	Area μS*min	Rel.Area %	Amount PPM	Type
1	4.09	FLUORIDE	4.360	0.604	56.84	0.2492	BMB*
2	6.19	CHLORIDE	2.604	0.459	43.16	0.2729	BMB*

19 0.25 PPM CHECK STD

Sample Name: **0.25 PPM CHECK STD**
Vial Number: **0**
Sample Type: **unknown**
Control Program: **Anions 2000**
Quantif. Method: **Anions 2000**
Recording Time: **4/11/2013 20:17**
Run Time (min): **25.00**

Injection Volume: **250.0**
Channel: **ECD_1**
Wavelength: **n.a.**
Bandwidth: **n.a.**
Dilution Factor: **1.0000**
Sample Weight: **1.0000**
Sample Amount: **1.0000**

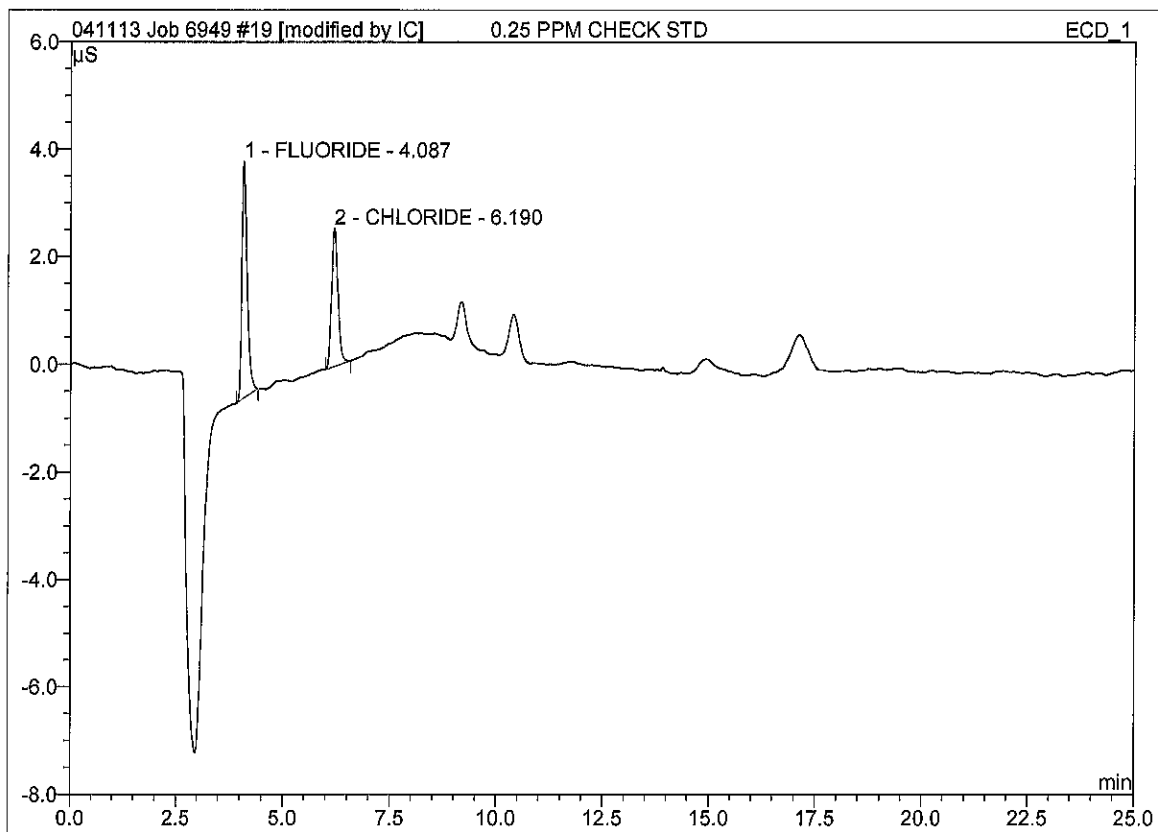

No.	Ret.Time min	Peak Name	Height μS	Area μS*min	Rel.Area %	Amount PPM	Type
1	4.09	FLUORIDE	4.401	0.625	58.64	0.2578	BMB*
2	6.19	CHLORIDE	2.571	0.441	41.36	0.2622	BMB

9 control	
Sample Name: control	Injection Volume: 250.0
Vial Number: 0	Channel: ECD_1
Sample Type: unknown	Wavelength: n.a.
Control Program: Anions 2000	Bandwidth: n.a.
Quantif. Method: Anions 2000	Dilution Factor: 1.0000
Recording Time: 4/11/2013 16:37	Sample Weight: 1.0000
Run Time (min): 25.00	Sample Amount: 1.0000

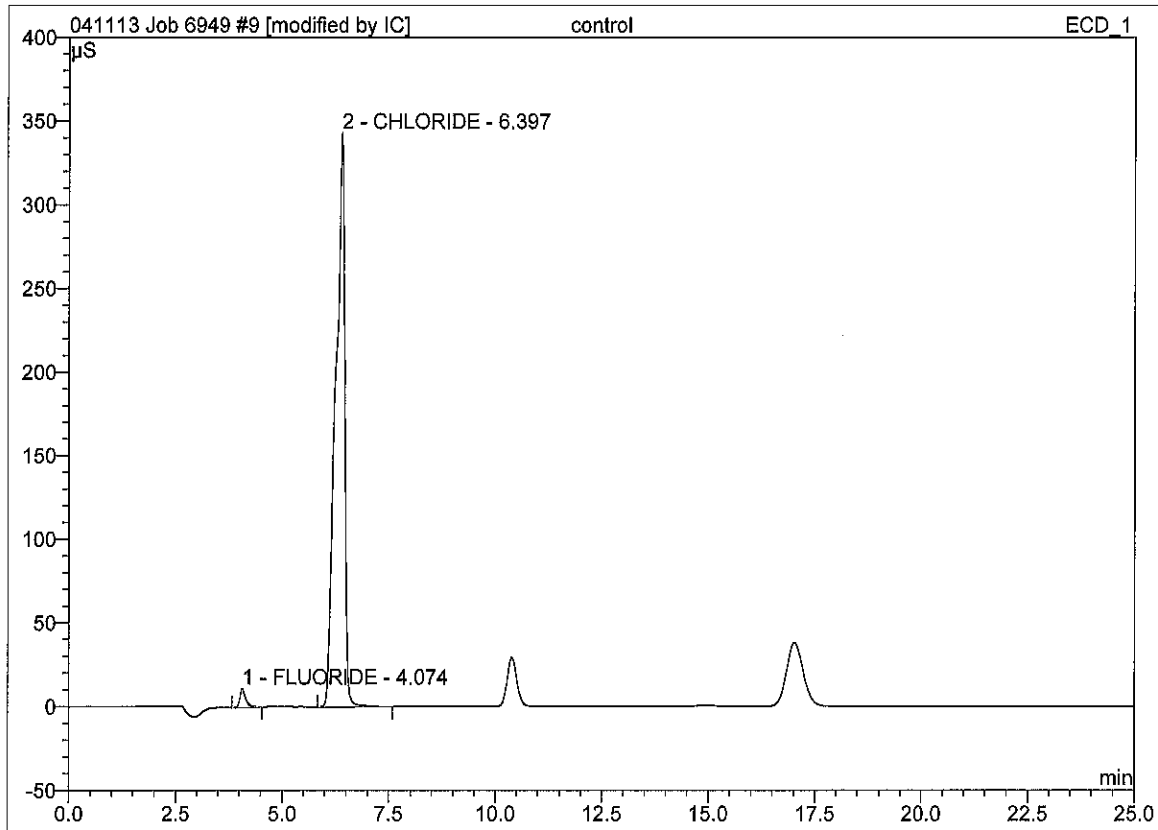

No.	Ret.Time min	Peak Name	Height μS	Area μS*min	Rel.Area %	Amount PPM	Type
1	4.07	FLUORIDE	11.065	1.743	1.98	0.7192	BMB*
2	6.40	CHLORIDE	342.929	86.185	98.02	51.2828	BMB

10 control			
Sample Name:	control	Injection Volume:	250.0
Vial Number:	0	Channel:	ECD_1
Sample Type:	unknown	Wavelength:	n.a.
Control Program:	Anions 2000	Bandwidth:	n.a.
Quantif. Method:	Anions 2000	Dilution Factor:	1.0000
Recording Time:	4/11/2013 17:05	Sample Weight:	1.0000
Run Time (min):	25.00	Sample Amount:	1.0000

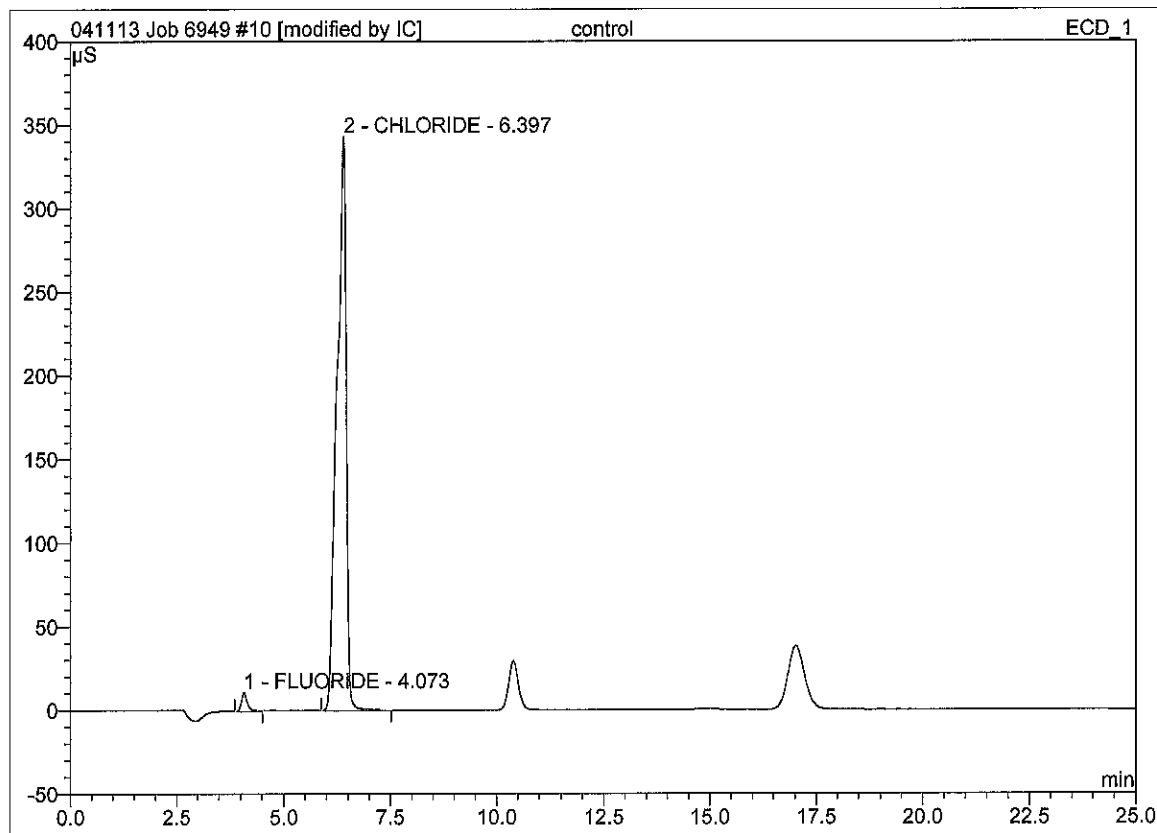

No.	Ret. Time min	Peak Name	Height μS	Area μS*min	Rel. Area %	Amount PPM	Type
1	4.07	FLUORIDE	11.039	1.733	1.97	0.7151	BMB*
2	6.40	CHLORIDE	342.904	86.315	98.03	51.3603	BMB*

33 CONTROL 2X

Sample Name: **CONTROL 2X**
Vial Number: **0**
Sample Type: **unknown**
Control Program: **Anions 2000**
Quantif. Method: **Anions 2000**
Recording Time: **4/12/2013 15:39**
Run Time (min): **25.00**

Injection Volume: **250.0**
Channel: **ECD_1**
Wavelength: **n.a.**
Bandwidth: **n.a.**
Dilution Factor: **1.0000**
Sample Weight: **1.0000**
Sample Amount: **1.0000**

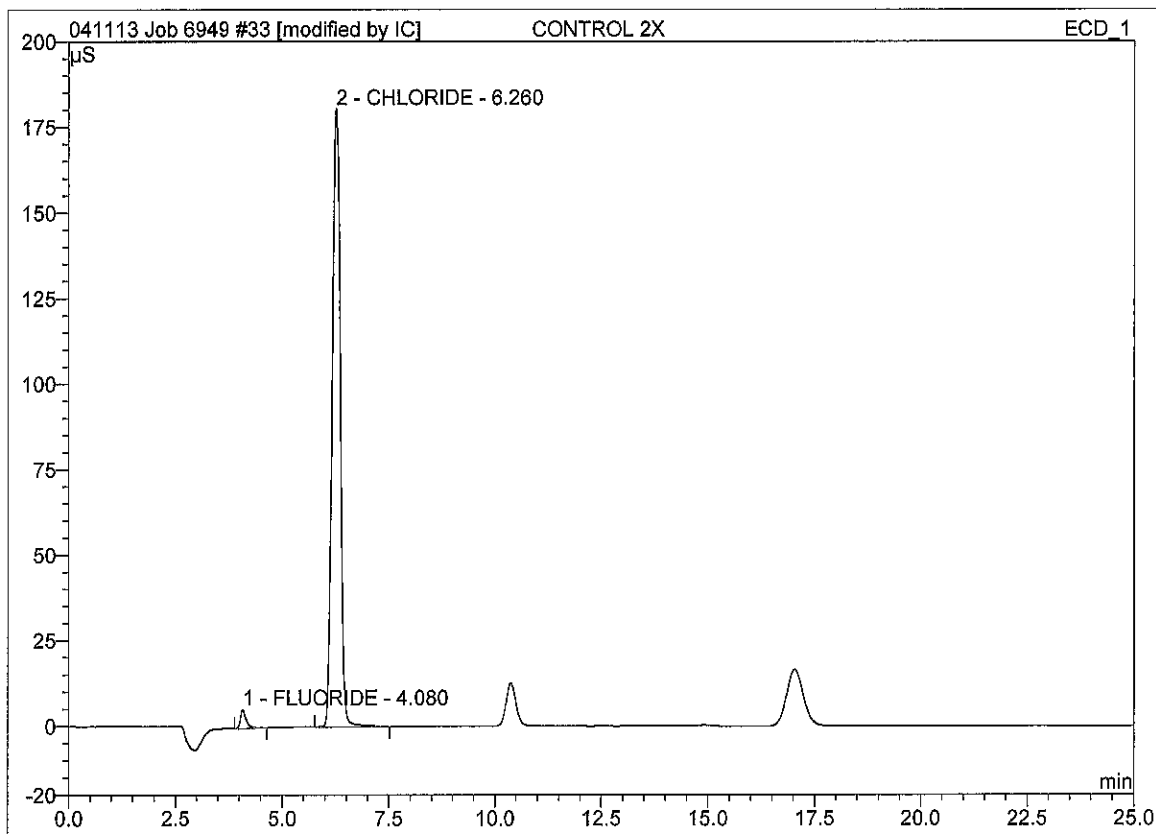

No.	Ret.Time min	Peak Name	Height μS	Area μS*min	Rel.Area %	Amount PPM	Type
1	4.08	FLUORIDE	5.383	0.812	2.02	0.3352	BMB*
2	6.26	CHLORIDE	180.370	39.409	97.98	23.4498	BMB*

32 CONTROL 2X		
Sample Name:	CONTROL 2X	Injection Volume: 250.0
Vial Number:	0	Channel: ECD_1
Sample Type:	unknown	Wavelength: n.a.
Control Program:	Anions 2000	Bandwidth: n.a.
Quantif. Method:	Anions 2000	Dilution Factor: 1.0000
Recording Time:	4/12/2013 15:12	Sample Weight: 1.0000
Run Time (min):	25.00	Sample Amount: 1.0000

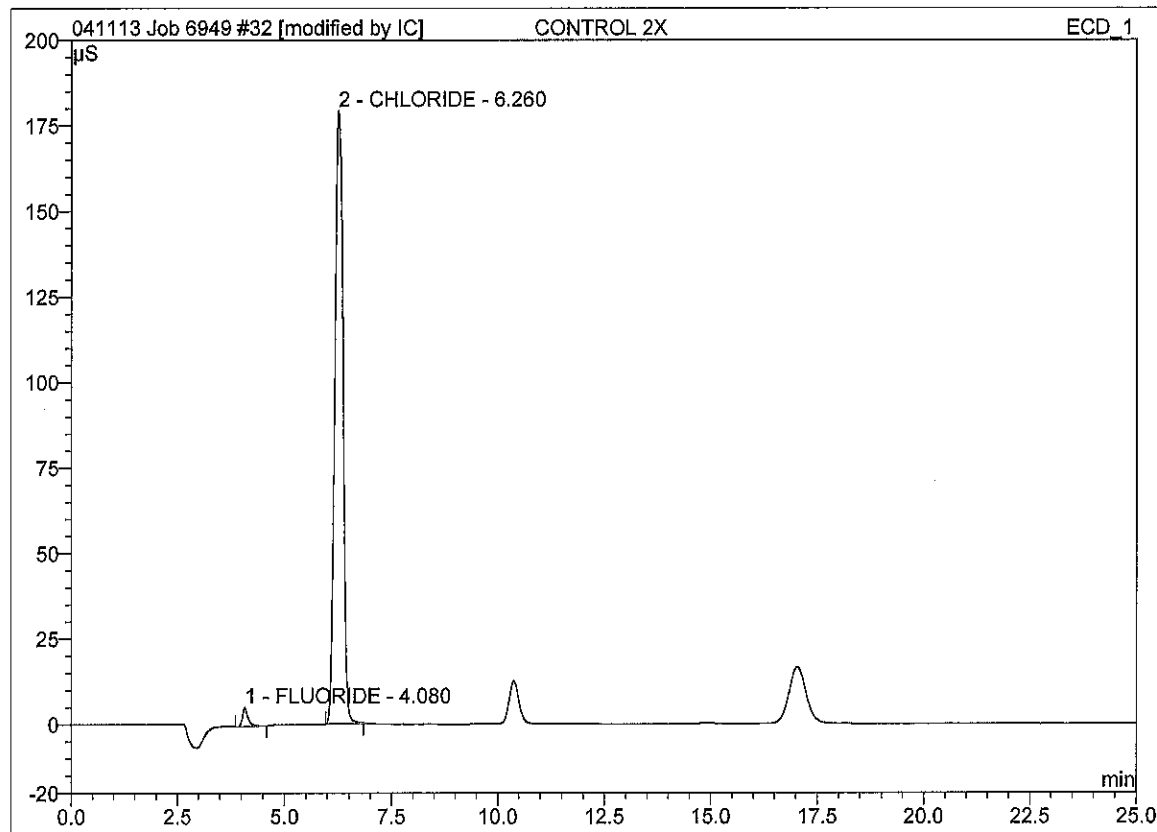

No.	Ret. Time min	Peak Name	Height μS	Area μS*min	Rel. Area %	Amount PPM	Type
1	4.08	FLUORIDE	5.370	0.796	2.00	0.3287	BMB*
2	6.26	CHLORIDE	178.936	38.963	98.00	23.1841	BMB*

24 CONTROL 200X

Sample Name:	CONTROL 200X	Injection Volume:	250.0
Vial Number:	0	Channel:	ECD_1
Sample Type:	unknown	Wavelength:	n.a.
Control Program:	Anions 2000	Bandwidth:	n.a.
Quantif. Method:	Anions 2000	Dilution Factor:	1.0000
Recording Time:	4/12/2013 10:38	Sample Weight:	1.0000
Run Time (min):	25.00	Sample Amount:	1.0000

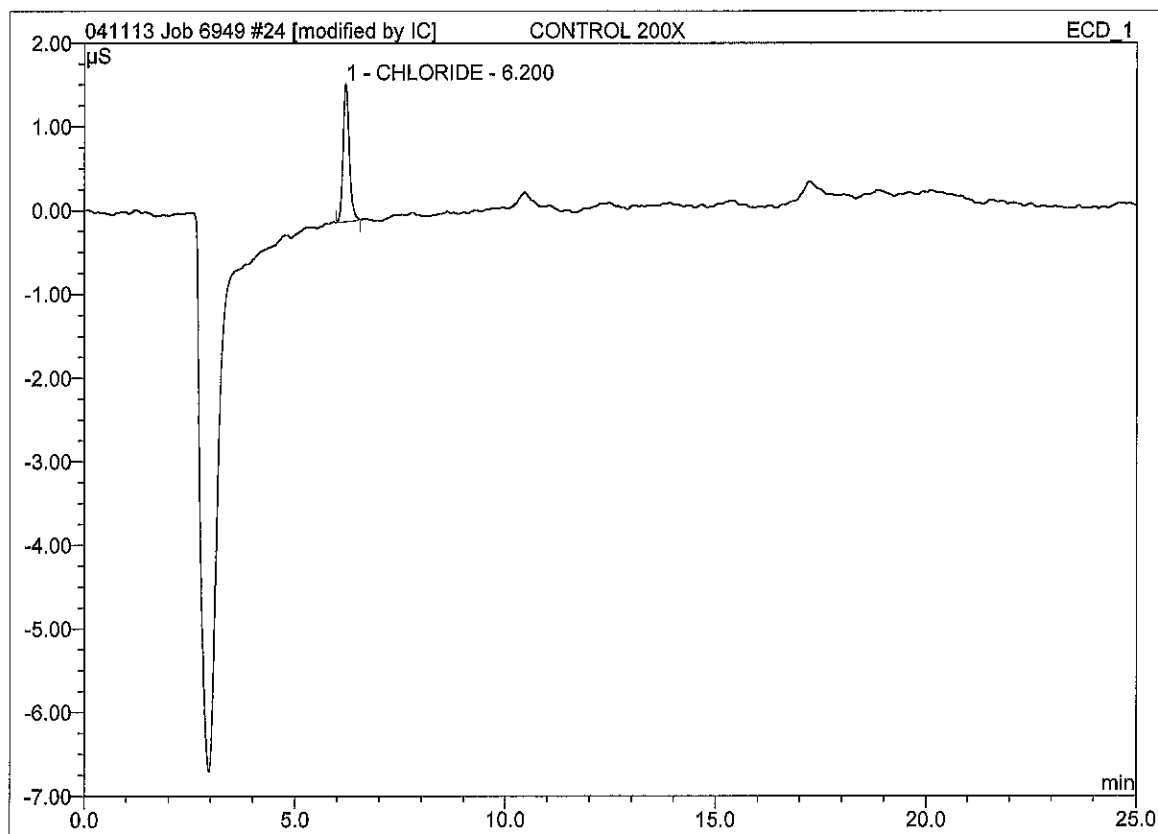

No.	Ret.Time min	Peak Name	Height µS	Area µS*min	Rel.Area %	Amount PPM	Type
1	6.20	CHLORIDE	1.641	0.286	100.00	0.1703	BMB

23 CONTROL 200X			
Sample Name:	CONTROL 200X	Injection Volume:	250.0
Vial Number:	0	Channel:	ECD_1
Sample Type:	unknown	Wavelength:	n.a.
Control Program:	Anions 2000	Bandwidth:	n.a.
Quantif. Method:	Anions 2000	Dilution Factor:	1.0000
Recording Time:	4/12/2013 11:05	Sample Weight:	1.0000
Run Time (min):	25.00	Sample Amount:	1.0000

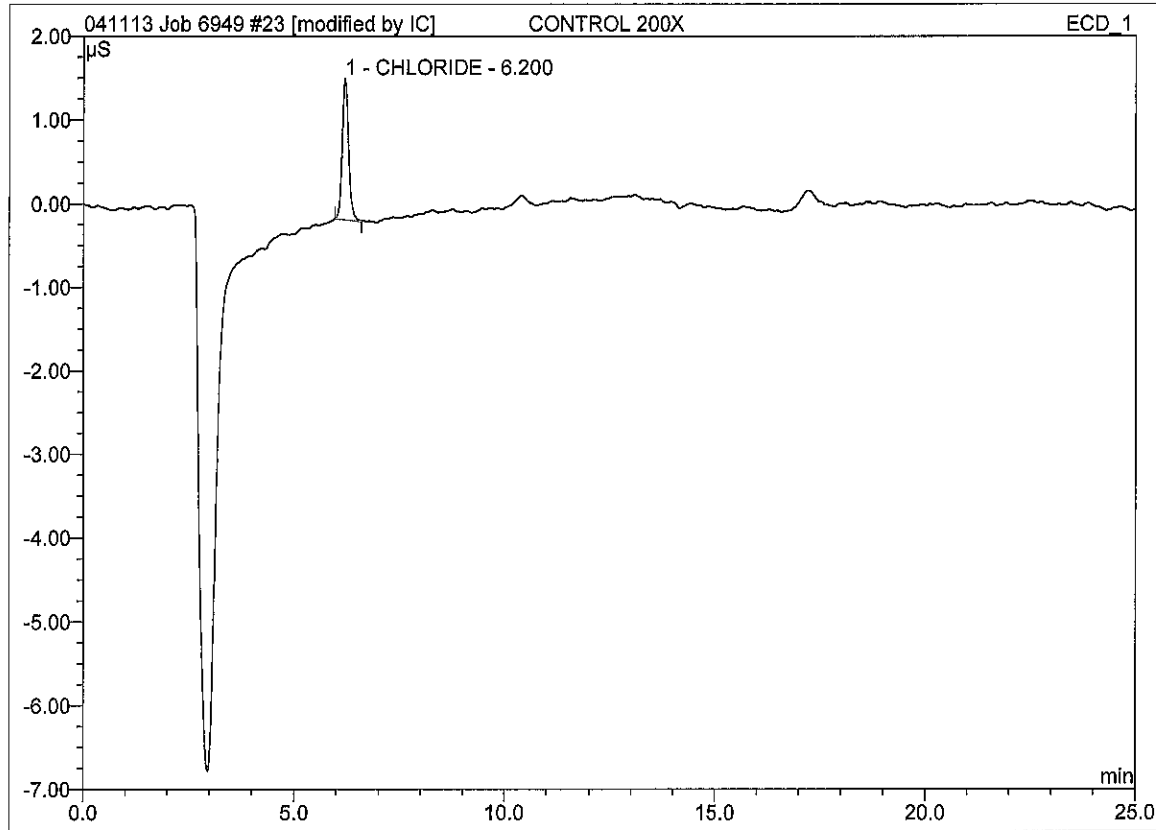

No.	Ret.Time min	Peak Name	Height μS	Area μS*min	Rel.Area %	Amount PPM	Type
1	6.20	CHLORIDE	1.674	0.293	100.00	0.1741	BMB*

11 TEST 3			
Sample Name:	TEST 3	Injection Volume:	250.0
Vial Number:	0	Channel:	ECD_1
Sample Type:	unknown	Wavelength:	n.a.
Control Program:	Anions 2000	Bandwidth:	n.a.
Quantif. Method:	Anions 2000	Dilution Factor:	1.0000
Recording Time:	4/11/2013 17:32	Sample Weight:	1.0000
Run Time (min):	25.00	Sample Amount:	1.0000

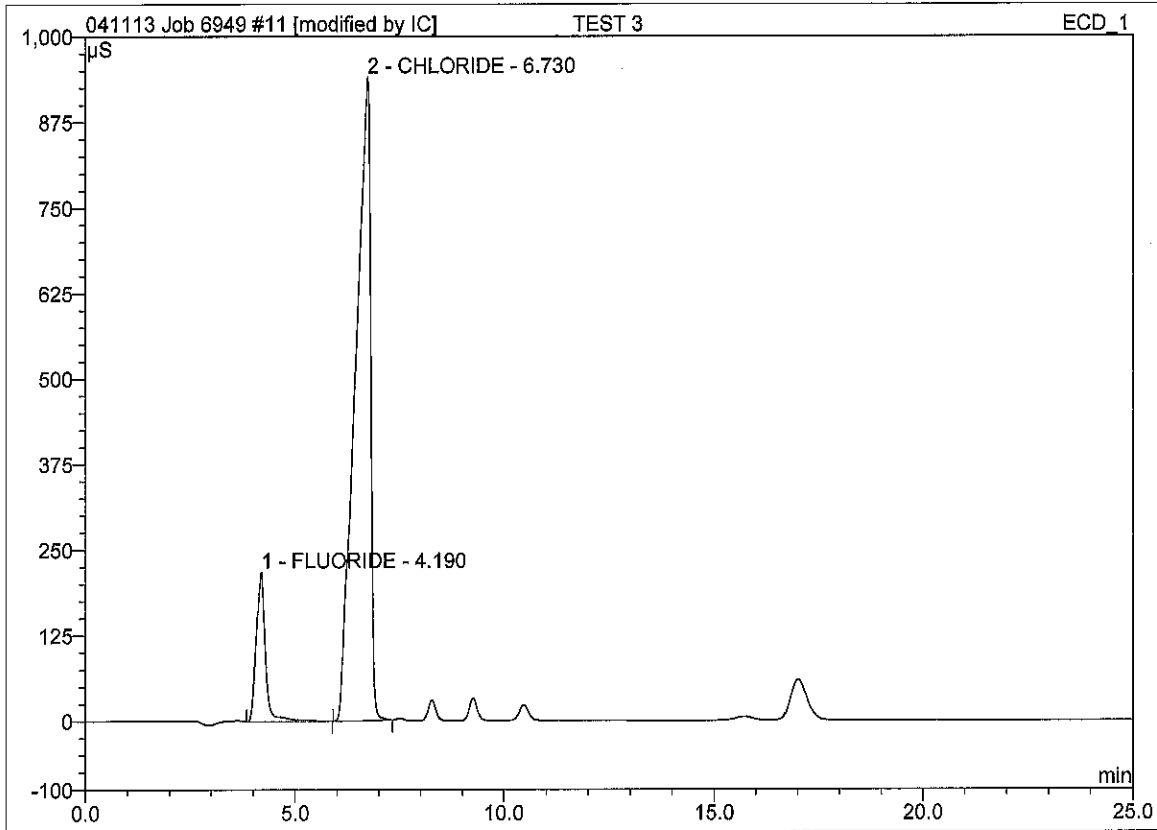

No.	Ret.Time min	Peak Name	Height μS	Area μS*min	Rel.Area %	Amount PPM	Type
1	4.19	FLUORIDE	216.799	54.832	12.24	22.6266	BMB*
2	6.73	CHLORIDE	939.147	393.218	87.76	233.9767	BMB*

28 TEST 3 100X		
Sample Name:	TEST 3 100X	Injection Volume: 250.0
Vial Number:	0	Channel: ECD_1
Sample Type:	unknown	Wavelength: n.a.
Control Program:	Anions 2000	Bandwidth: n.a.
Quantif. Method:	Anions 2000	Dilution Factor: 1.0000
Recording Time:	4/12/2013 13:22	Sample Weight: 1.0000
Run Time (min):	25.00	Sample Amount: 1.0000

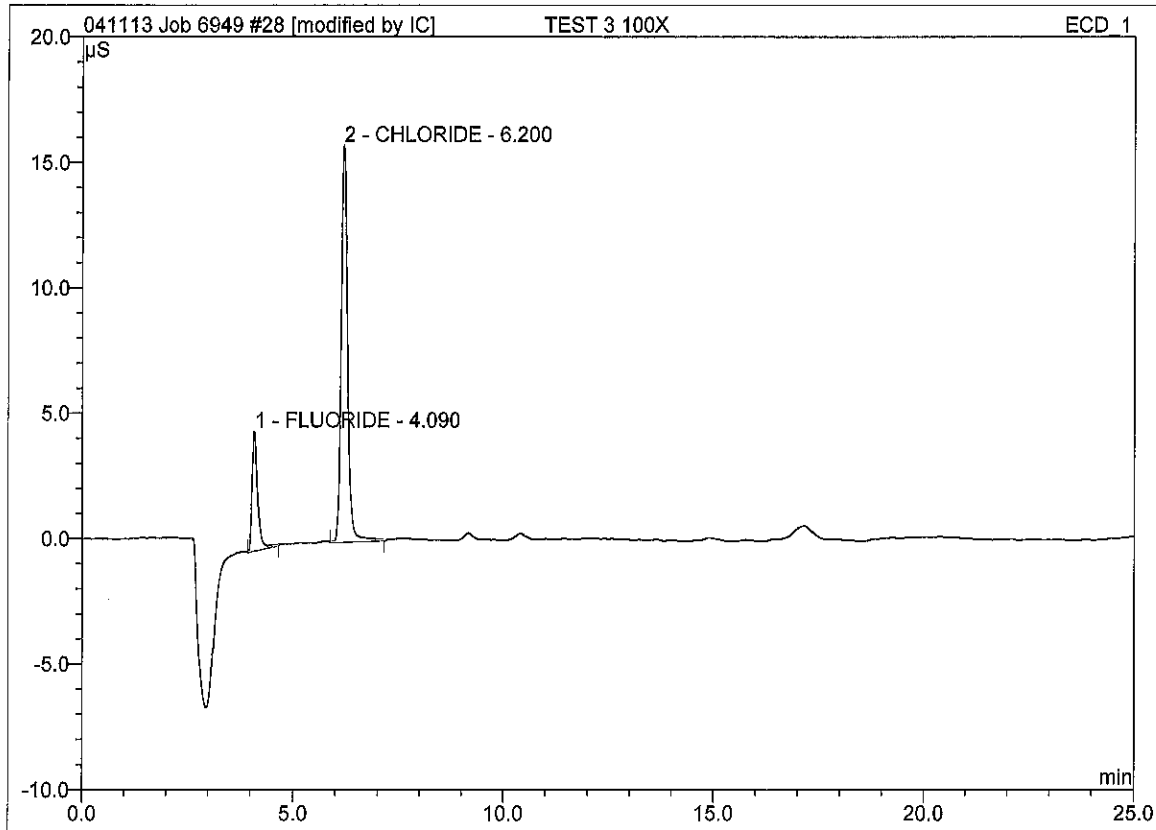

No.	Ret.Time min	Peak Name	Height μS	Area $\mu\text{S}\cdot\text{min}$	Rel.Area %	Amount PPM	Type
1	4.09	FLUORIDE	4.720	0.666	19.74	0.2748	BMB*
2	6.20	CHLORIDE	15.768	2.708	80.26	1.6112	BMB*

29 TEST 3 100X			
Sample Name:	TEST 3 100X	Injection Volume:	250.0
Vial Number:	0	Channel:	ECD_1
Sample Type:	unknown	Wavelength:	n.a.
Control Program:	Anions 2000	Bandwidth:	n.a.
Quantif. Method:	Anions 2000	Dilution Factor:	1.0000
Recording Time:	4/12/2013 13:50	Sample Weight:	1.0000
Run Time (min):	25.00	Sample Amount:	1.0000

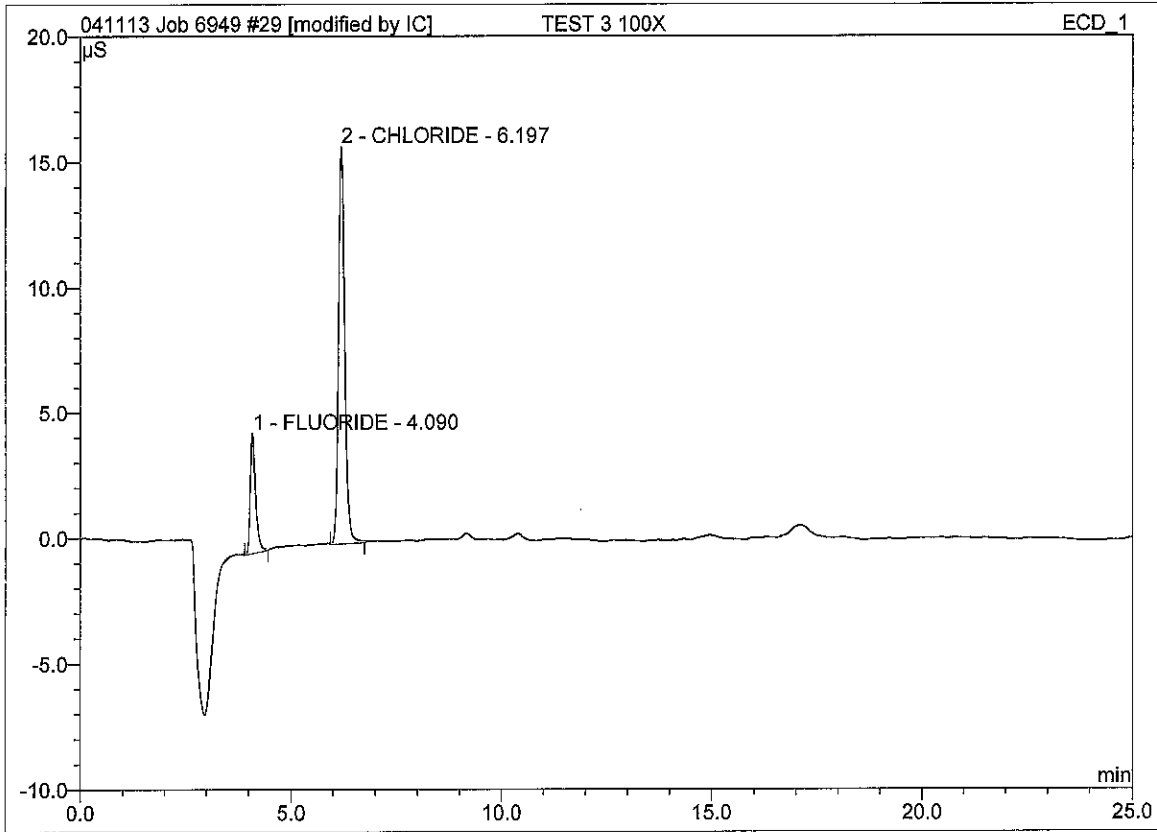

No.	Ret.Time min	Peak Name	Height µS	Area µS*min	Rel.Area %	Amount PPM	Type
1	4.09	FLUORIDE	4.734	0.657	19.83	0.2713	BMB
2	6.20	CHLORIDE	15.790	2.658	80.17	1.5816	BMB

24 TEST 3 1000X

Sample Name: **TEST 3 1000X**
 Vial Number: **0**
 Sample Type: **unknown**
 Control Program: **Anions 2000**
 Quantif. Method: **Anions 2000**
 Recording Time: **4/12/2013 11:33**
 Run Time (min): **25.00**

Injection Volume: **250.0**
 Channel: **ECD_1**
 Wavelength: **n.a.**
 Bandwidth: **n.a.**
 Dilution Factor: **1.0000**
 Sample Weight: **1.0000**
 Sample Amount: **1.0000**

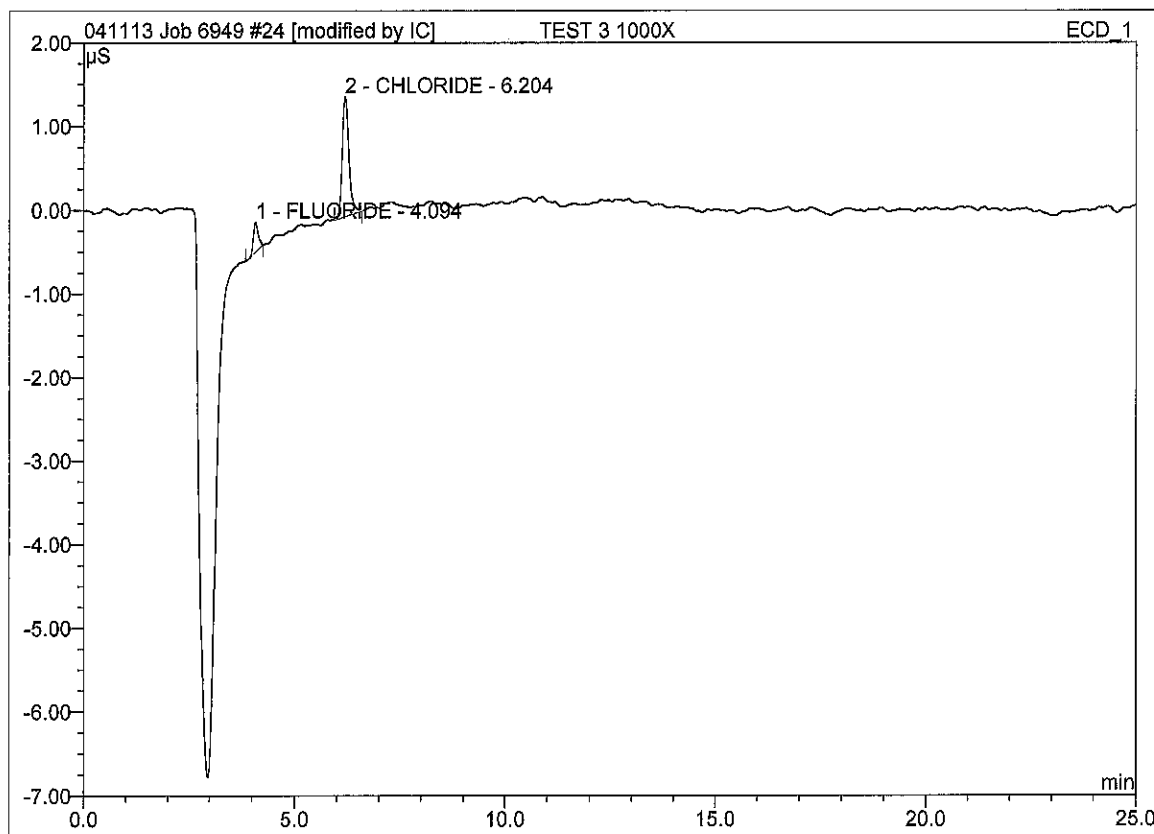

No.	Ret.Time min	Peak Name	Height μS	Area μS*min	Rel.Area %	Amount PPM	Type
1	4.09	FLUORIDE	0.354	0.047	15.58	0.0193	BMB*
2	6.20	CHLORIDE	1.419	0.254	84.42	0.1510	BMB*

25 TEST 3 1000X

Sample Name: **TEST 3 1000X**
 Vial Number: **0**
 Sample Type: **unknown**
 Control Program: **Anions 2000**
 Quantif. Method: **Anions 2000**
 Recording Time: **4/12/2013 12:00**
 Run Time (min): **25.00**

Injection Volume: **250.0**
 Channel: **ECD_1**
 Wavelength: **n.a.**
 Bandwidth: **n.a.**
 Dilution Factor: **1.0000**
 Sample Weight: **1.0000**
 Sample Amount: **1.0000**

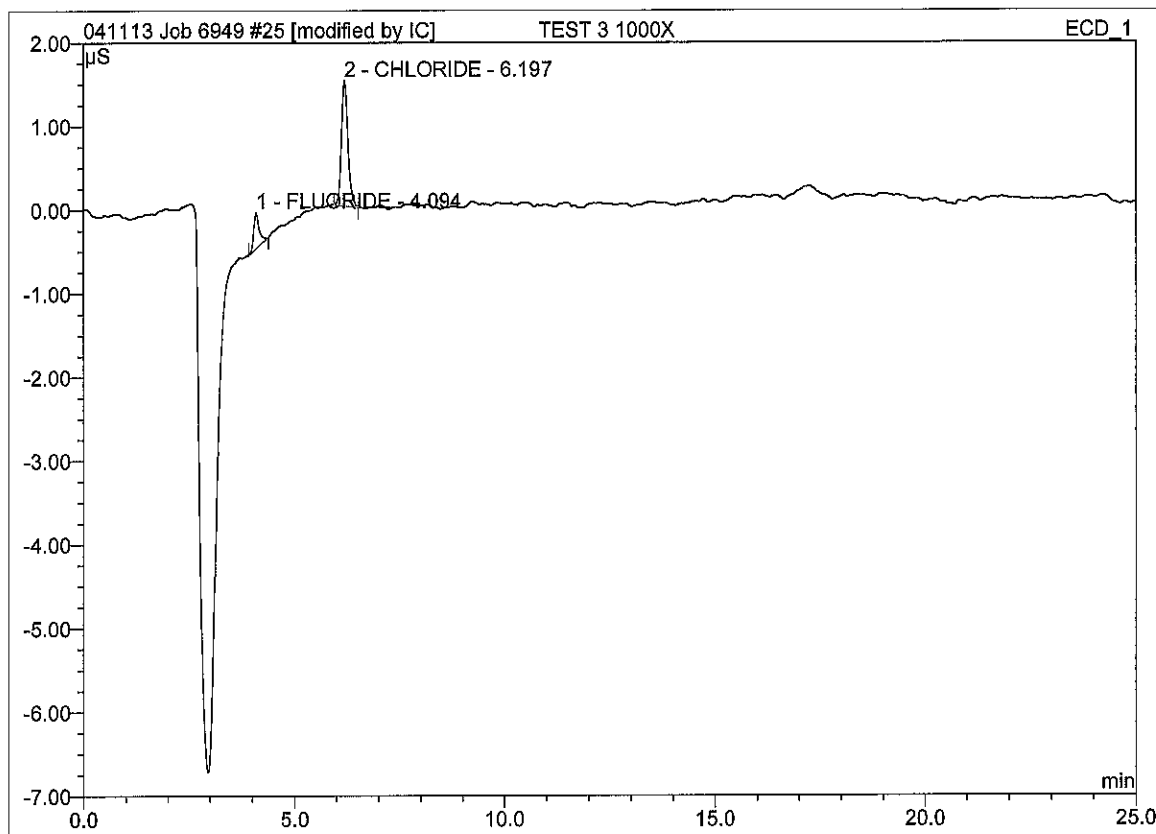

No.	Ret.Time min	Peak Name	Height μS	Area $\mu\text{S}\cdot\text{min}$	Rel.Area %	Amount PPM	Type
1	4.09	FLUORIDE	0.424	0.062	18.97	0.0255	BMB*
2	6.20	CHLORIDE	1.486	0.264	81.03	0.1570	BMB*

13 TEST 6

Sample Name: **TEST 6**
Vial Number: **0**
Sample Type: **unknown**
Control Program: **Anions 2000**
Quantif. Method: **Anions 2000**
Recording Time: **4/11/2013 18:27**
Run Time (min): **25.00**

Injection Volume: **250.0**
Channel: **ECD_1**
Wavelength: **n.a.**
Bandwidth: **n.a.**
Dilution Factor: **1.0000**
Sample Weight: **1.0000**
Sample Amount: **1.0000**

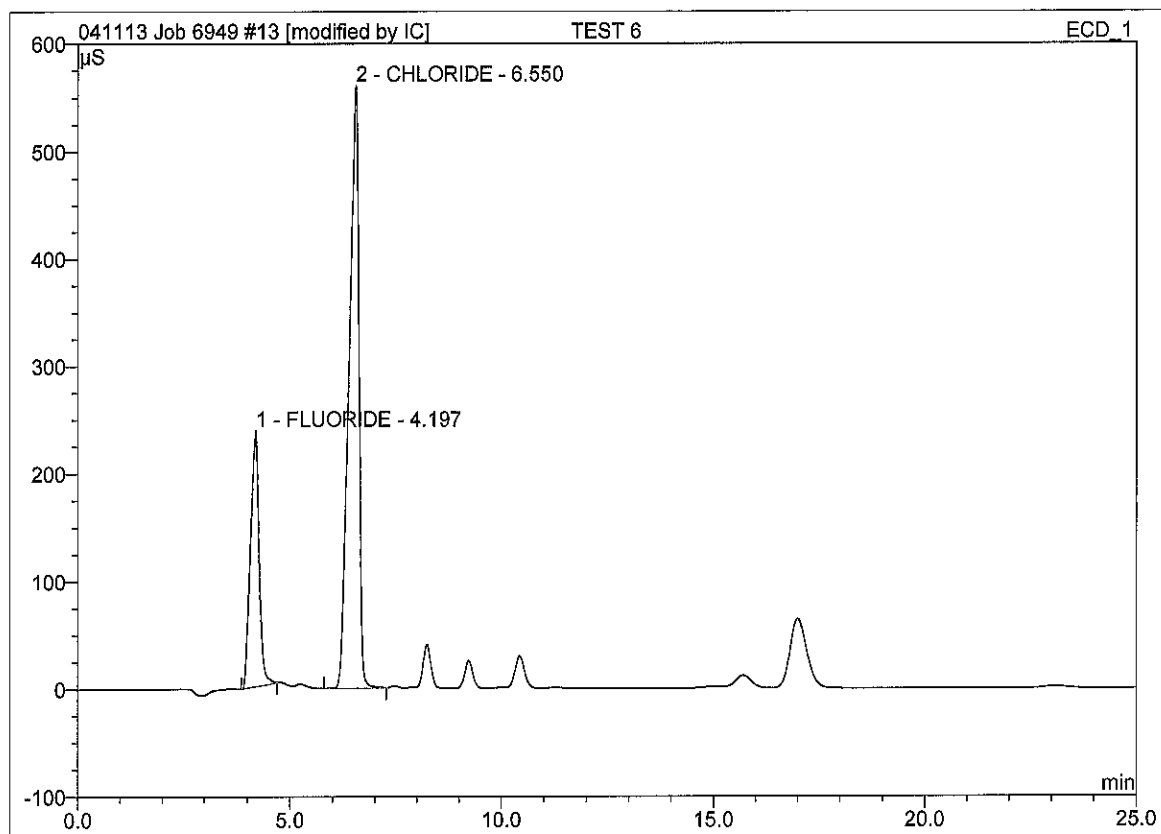

No.	Ret.Time min	Peak Name	Height μS	Area μS*min	Rel.Area %	Amount PPM	Type
1	4.20	FLUORIDE	237.064	56.168	27.23	23.1780	BMB*
2	6.55	CHLORIDE	559.984	150.088	72.77	89.3072	BMB*

14 TEST 6

Sample Name: **TEST 6**
Vial Number: **0**
Sample Type: **unknown**
Control Program: **Anions 2000**
Quantif. Method: **Anions 2000**
Recording Time: **4/11/2013 18:54**
Run Time (min): **25.00**

Injection Volume: **250.0**
Channel: **ECD_1**
Wavelength: **n.a.**
Bandwidth: **n.a.**
Dilution Factor: **1.0000**
Sample Weight: **1.0000**
Sample Amount: **1.0000**

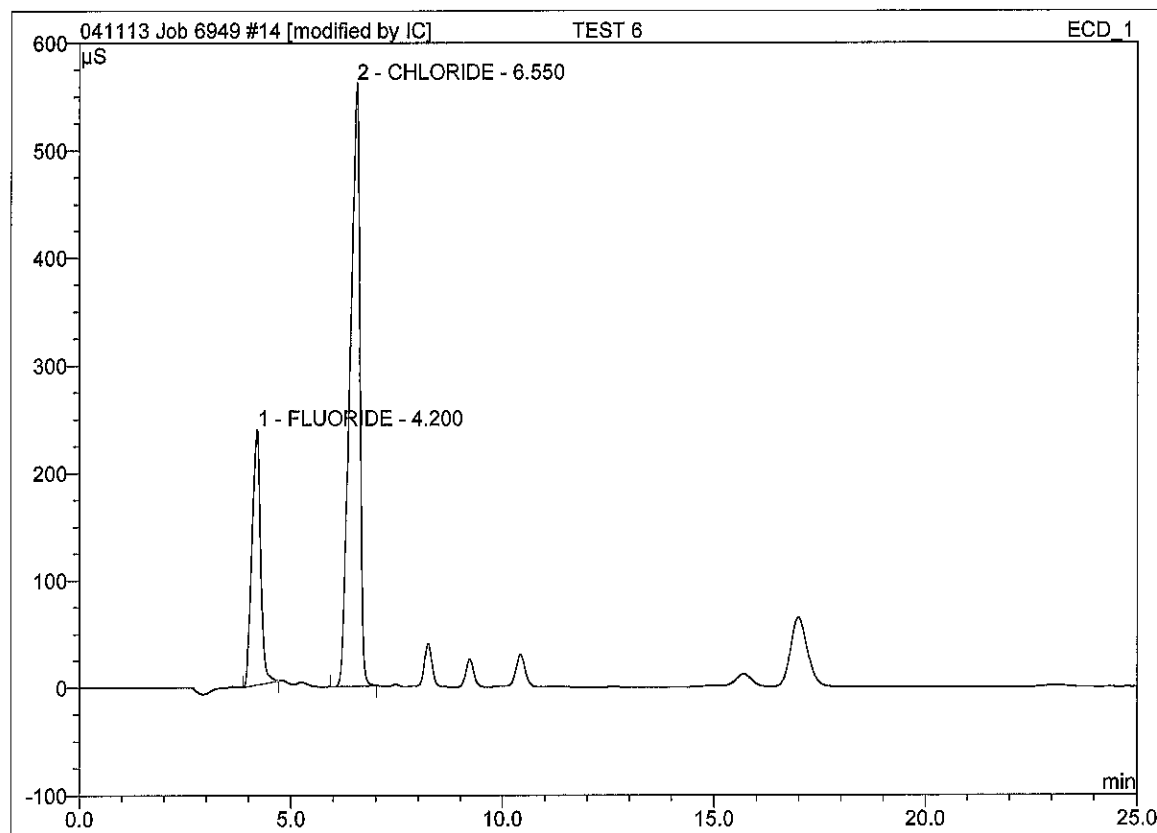

No.	Ret. Time min	Peak Name	Height μS	Area μS*min	Rel. Area %	Amount PPM	Type
1	4.20	FLUORIDE	237.323	56.093	27.30	23.1469	BMB*
2	6.55	CHLORIDE	560.460	149.357	72.70	88.8721	BMB*

30 TEST 6 100X			
Sample Name:	TEST 6 100X	Injection Volume:	250.0
Vial Number:	0	Channel:	ECD_1
Sample Type:	unknown	Wavelength:	n.a.
Control Program:	Anions 2000	Bandwidth:	n.a.
Quantif. Method:	Anions 2000	Dilution Factor:	1.0000
Recording Time:	4/12/2013 14:17	Sample Weight:	1.0000
Run Time (min):	25.00	Sample Amount:	1.0000

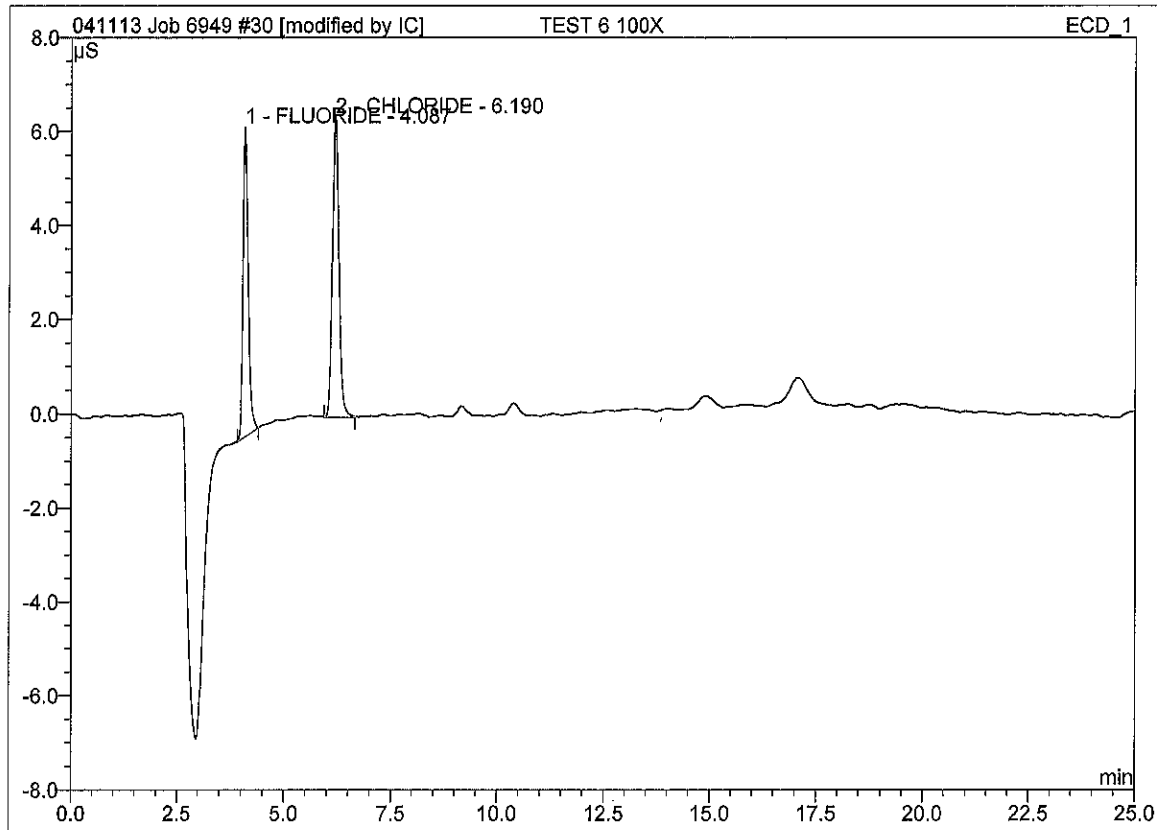

No.	Ret.Time min	Peak Name	Height µS	Area µS*min	Rel.Area %	Amount PPM	Type
1	4.09	FLUORIDE	6.567	0.898	45.04	0.3707	BMB
2	6.19	CHLORIDE	6.362	1.096	54.96	0.6522	BMB

31 TEST 6 100X		
Sample Name:	TEST 6 100X	Injection Volume: 250.0
Vial Number:	0	Channel: ECD_1
Sample Type:	unknown	Wavelength: n.a.
Control Program:	Anions 2000	Bandwidth: n.a.
Quantif. Method:	Anions 2000	Dilution Factor: 1.0000
Recording Time:	4/12/2013 14:45	Sample Weight: 1.0000
Run Time (min):	25.00	Sample Amount: 1.0000

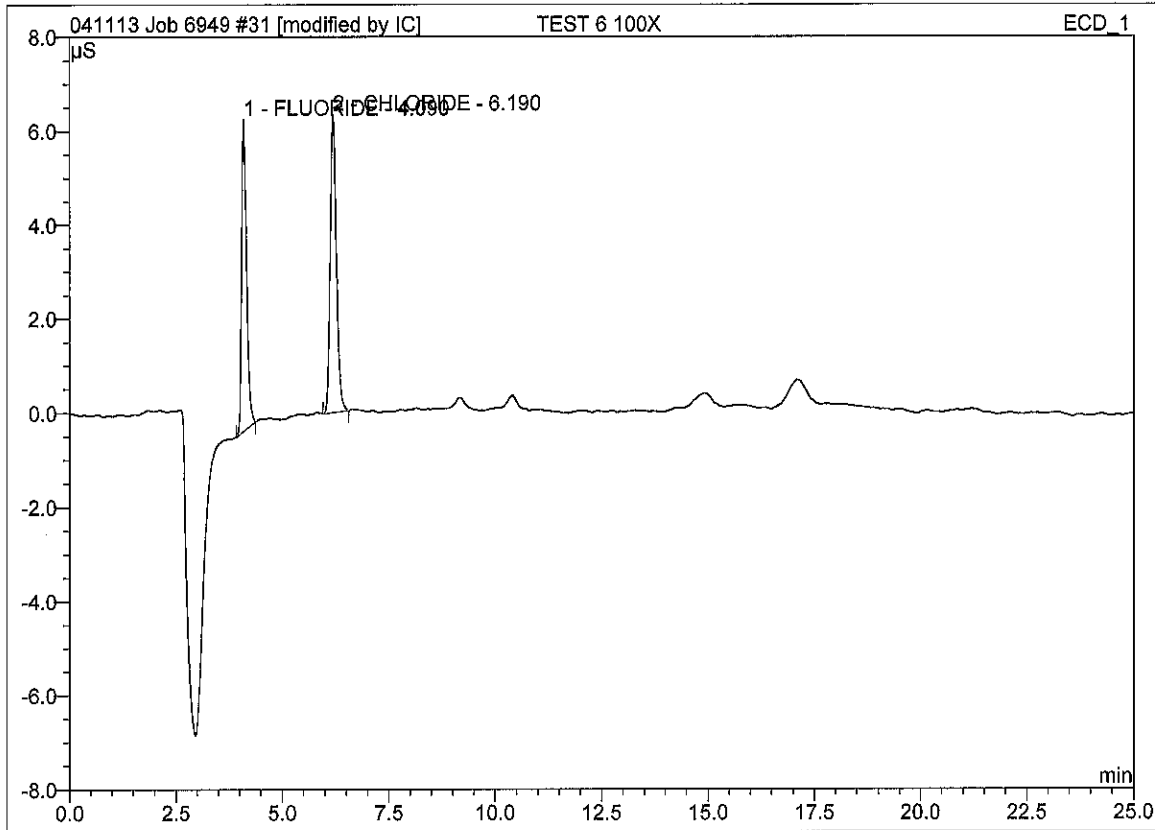

No.	Ret.Time min	Peak Name	Height µS	Area µS*min	Rel.Area %	Amount PPM	Type
1	4.09	FLUORIDE	6.626	0.897	45.53	0.3701	BMB*
2	6.19	CHLORIDE	6.323	1.073	54.47	0.6386	BMB*

27 TEST 6 500X			
Sample Name:	TEST 6 500X	Injection Volume:	250.0
Vial Number:	0	Channel:	ECD_1
Sample Type:	unknown	Wavelength:	n.a.
Control Program:	Anions 2000	Bandwidth:	n.a.
Quantif. Method:	Anions 2000	Dilution Factor:	1.0000
Recording Time:	4/12/2013 12:55	Sample Weight:	1.0000
Run Time (min):	25.00	Sample Amount:	1.0000

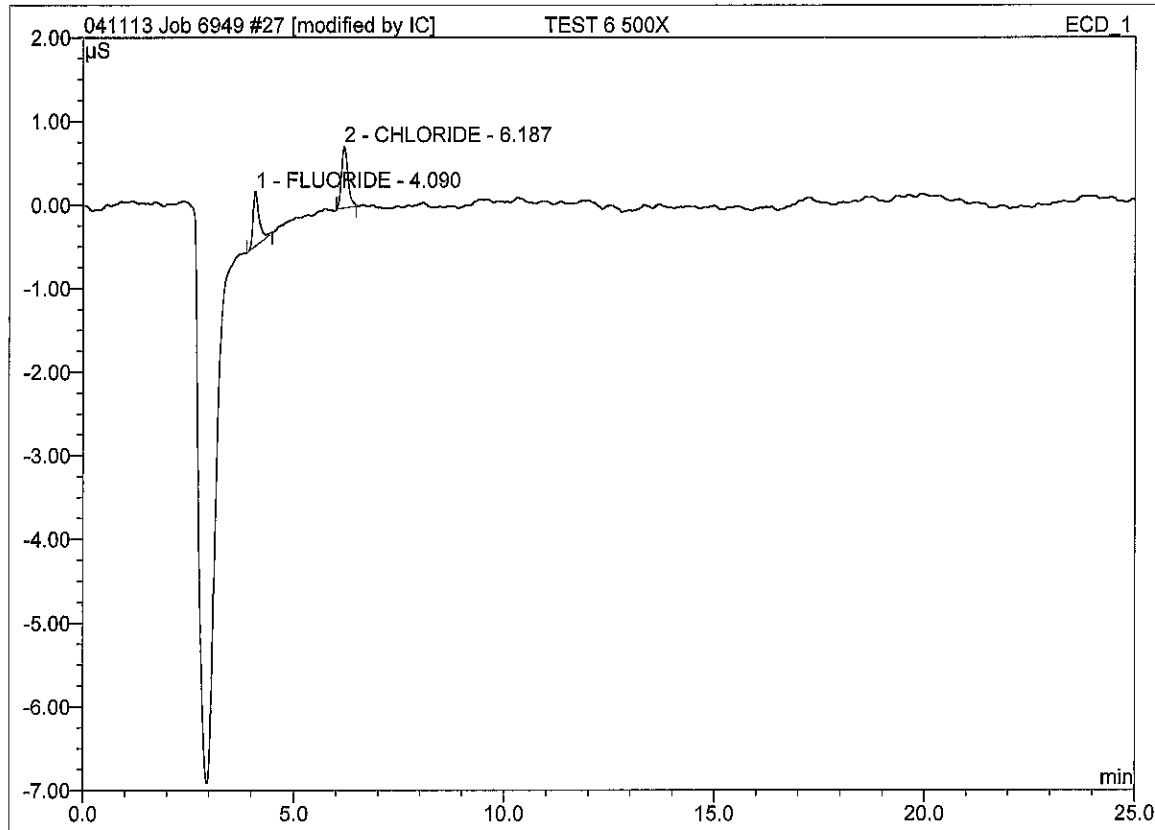

No.	Ret. Time min	Peak Name	Height µS	Area µS*min	Rel. Area %	Amount PPM	Type
1	4.09	FLUORIDE	0.648	0.104	44.87	0.0428	BMB
2	6.19	CHLORIDE	0.734	0.127	55.13	0.0758	BMB*

26 TEST 6 500X

Sample Name: TEST 6 500X
Vial Number: 0
Sample Type: unknown
Control Program: Anions 2000
Quantif. Method: Anions 2000
Recording Time: 4/12/2013 12:28
Run Time (min): 25.00

Injection Volume: 250.0
Channel: ECD_1
Wavelength: n.a.
Bandwidth: n.a.
Dilution Factor: 1.0000
Sample Weight: 1.0000
Sample Amount: 1.0000

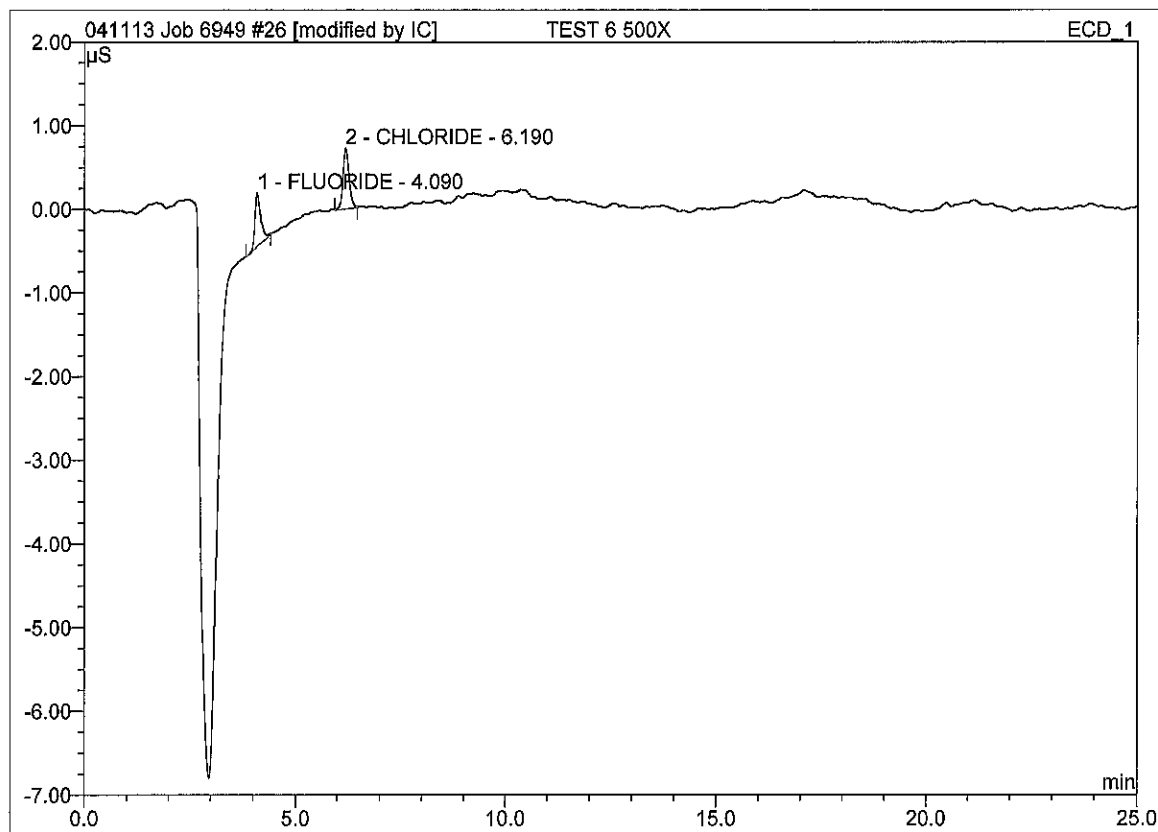

No.	Ret.Time min	Peak Name	Height μS	Area $\mu\text{S}\cdot\text{min}$	Rel.Area %	Amount PPM	Type
1	4.09	FLUORIDE	0.641	0.099	45.21	0.0408	BMB*
2	6.19	CHLORIDE	0.717	0.120	54.79	0.0713	BMB*

APPENDIX

Elemental Analyses

AnalysisNow!

Customer: ANALYZE	Sample Number: 42436
Address: 318 S. Bracken Lane	Purchase Order: 3112-6949
City: Chandler	Sample Type: Process Solution
State: AZ	Date/Time In: 4/11/2013 11:16:15 AM
Zip: 85224	Date/Time Out: 04/15/2013 11:55 AM

E-mail transmission

Trace Elements, ppb

Li: < 5	Zn: < 5	Ta: < 2
Be: < 2	Ga: < 2	W: < 5
B: 11	Ge: < 5	Au: < 5
Mg: 4800	As: < 10	Tl: < 2
Al: 8.5	Sr: 82	Pb: < 2
Ti: < 10	Zr: < 2	Bi: < 2
V: < 2	Nb: < 2	Th: < 5
Cr: < 5	Mo: < 5	U: < 5
Mn: < 5	Ag: < 5	Fe: 90
Ni: < 10	Cd: < 5	Na: 13000
Co: < 5	Sn: < 5	Ca: 23000
Cu: < 5	Sb: < 2	K: 2400
	Ba: 24	

Comments: Control; 3/27/13; AFB
P = <1.0ppm; TIC = 7.3ppm; TOC = 1.3ppm

(signature on file)

Kirsten B. Smith
Laboratory Manager

AnalysisNow!

Customer: ANALYZE	Sample Number: 42437
Address: 318 S. Bracken Lane	Purchase Order: 3112-6949
City: Chandler	Sample Type: Process Solution
State: AZ	Date/Time In: 4/11/2013 11:19:25 AM
Zip: 85224	Date/Time Out: 04/15/2013 11:55 AM

E-mail transmission

Trace Elements, ppb

Li: 250	Zn: 29000	Ta: < 2
Be: < 2	Ga: < 2	W: < 5
B: 53	Ge: < 5	Au: < 5
Mg: 6900	As: < 10	Tl: < 2
Al: 3000	Sr: 4500	Pb: < 2
Ti: < 10	Zr: < 2	Bi: < 2
V: 2	Nb: < 2	Th: < 5
Cr: < 5	Mo: < 5	U: < 5
Mn: 270	Ag: < 5	Fe: 720
Ni: 51	Cd: < 5	Na: 19000
Co: 16	Sn: < 5	Ca: 72000
Cu: 150	Sb: 700	K: 6000
	Ba: 610	

Comments: Test 3; 3/28/13; AFB
P = 7.5ppm; TIC = 7.7ppm; TOC = 150ppm

(signature on file)

Kirsten B. Smith
Laboratory Manager

AnalysisNow!

Customer: ANALYZE	Sample Number: 42438
Address: 318 S. Bracken Lane	Purchase Order: 3112-6949
City: Chandler	Sample Type: Process Solution
State: AZ	Date/Time In: 4/11/2013 11:20:12 AM
Zip: 85224	Date/Time Out: 04/15/2013 11:55 AM

E-mail transmission

Trace Elements, ppb

Li: 3600	Zn: 2700	Ta: < 2
Be: < 2	Ga: < 2	W: < 5
B: 1800	Ge: < 5	Au: < 5
Mg: 7000	As: < 10	Tl: < 2
Al: 1000	Sr: 440	Pb: < 2
Ti: < 10	Zr: 2	Bi: < 2
V: 2.9	Nb: < 2	Th: < 5
Cr: < 5	Mo: 5	U: < 5
Mn: 4600	Ag: < 5	Fe: 170
Ni: 690	Cd: < 5	Na: 17000
Co: 760	Sn: < 5	Ca: 42000
Cu: 140	Sb: 700	K: 4800
	Ba: 270	

Comments: Test 6; 4/3/13; AFB
P = 11ppm; TIC = 21ppm; TOC = 360ppm

(signature on file)

Kirsten B. Smith
Laboratory Manager

Appendix E Electrical Measurements

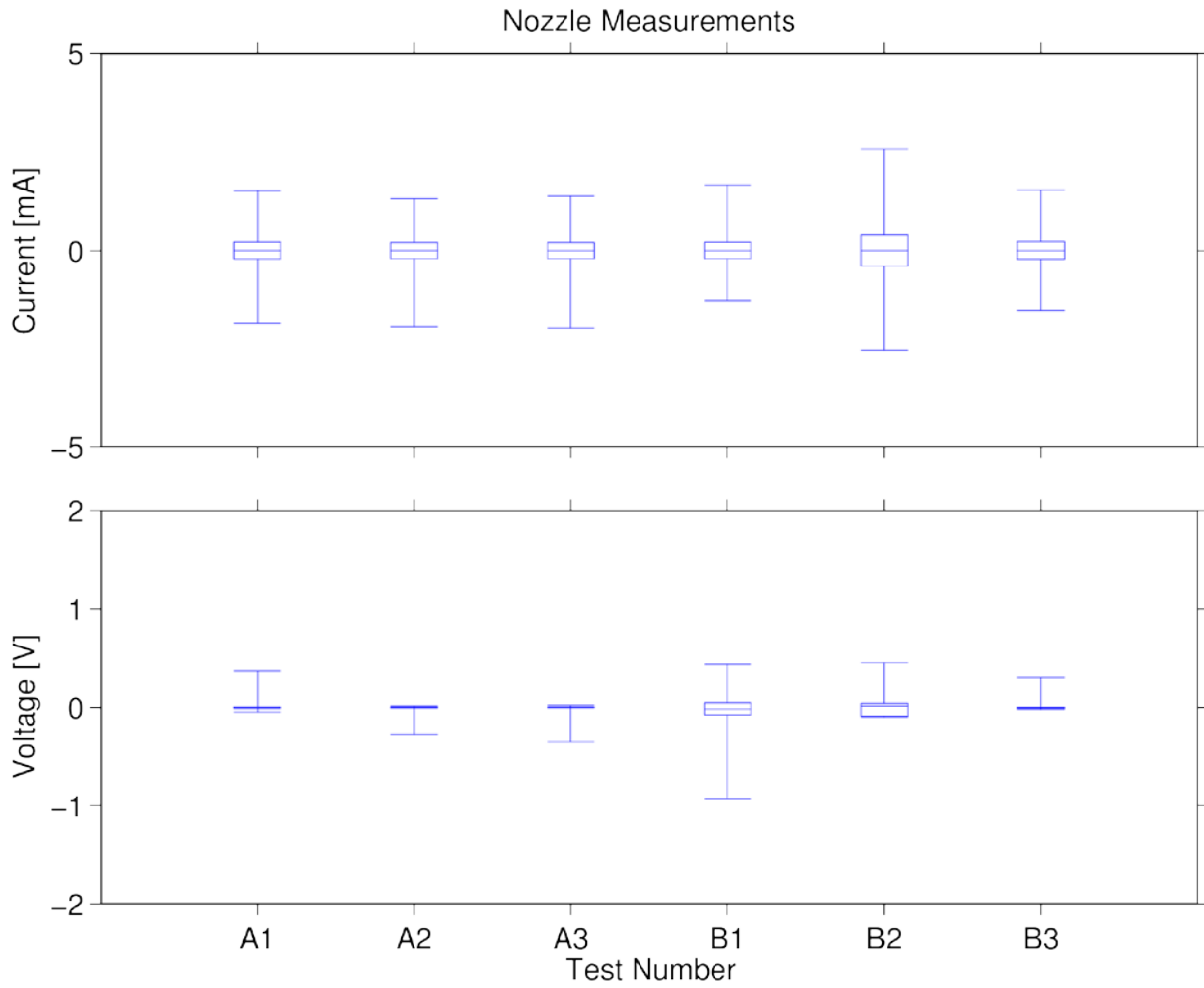

Figure E.1 Box plot indicating the maximum, minimum, median, first quartile and third quartile measurement for nozzle voltage and current measurements

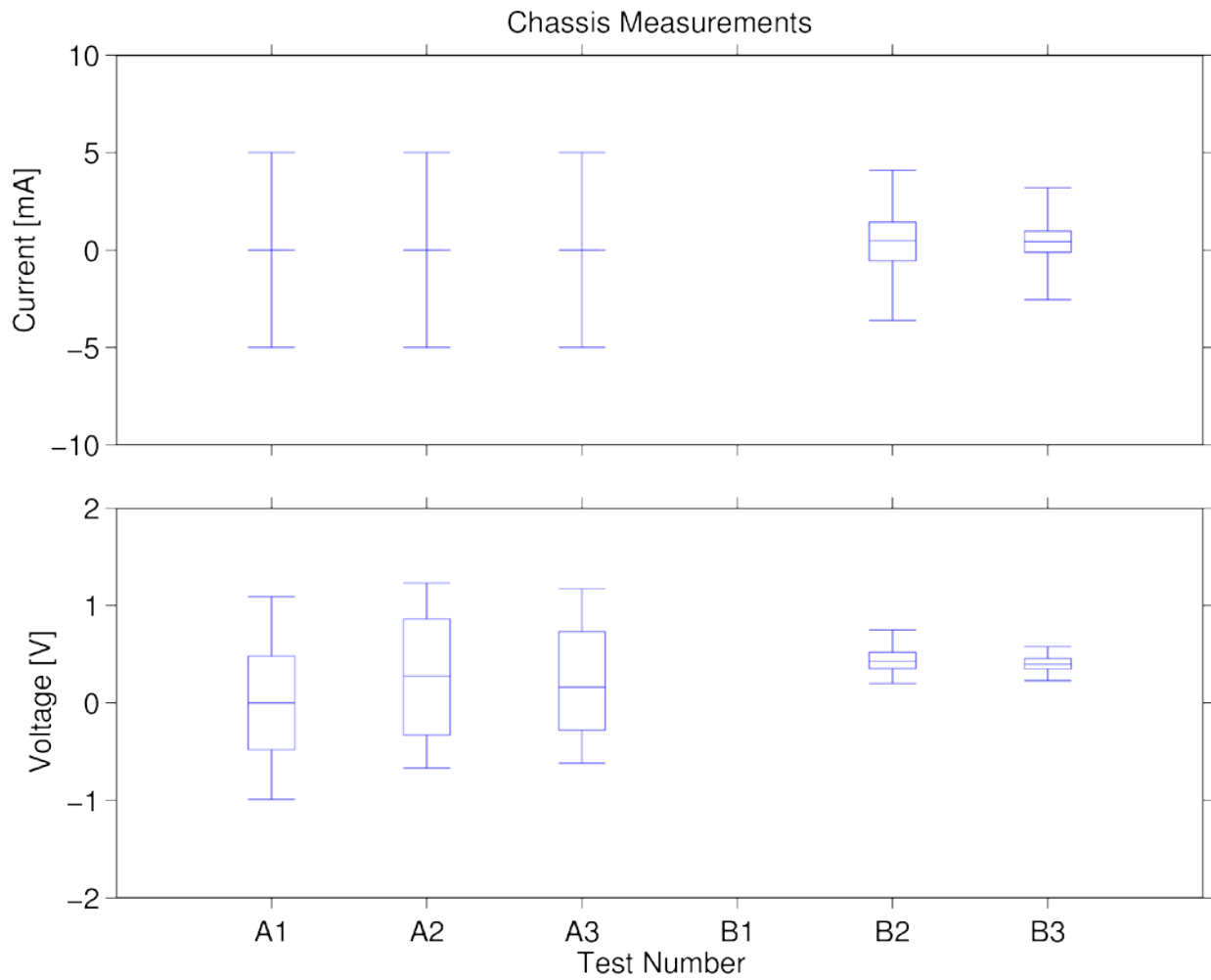

Figure E.2 Box plot indicating the maximum, minimum, median, first quartile and third quartile measurement for chassis voltage and current measurements

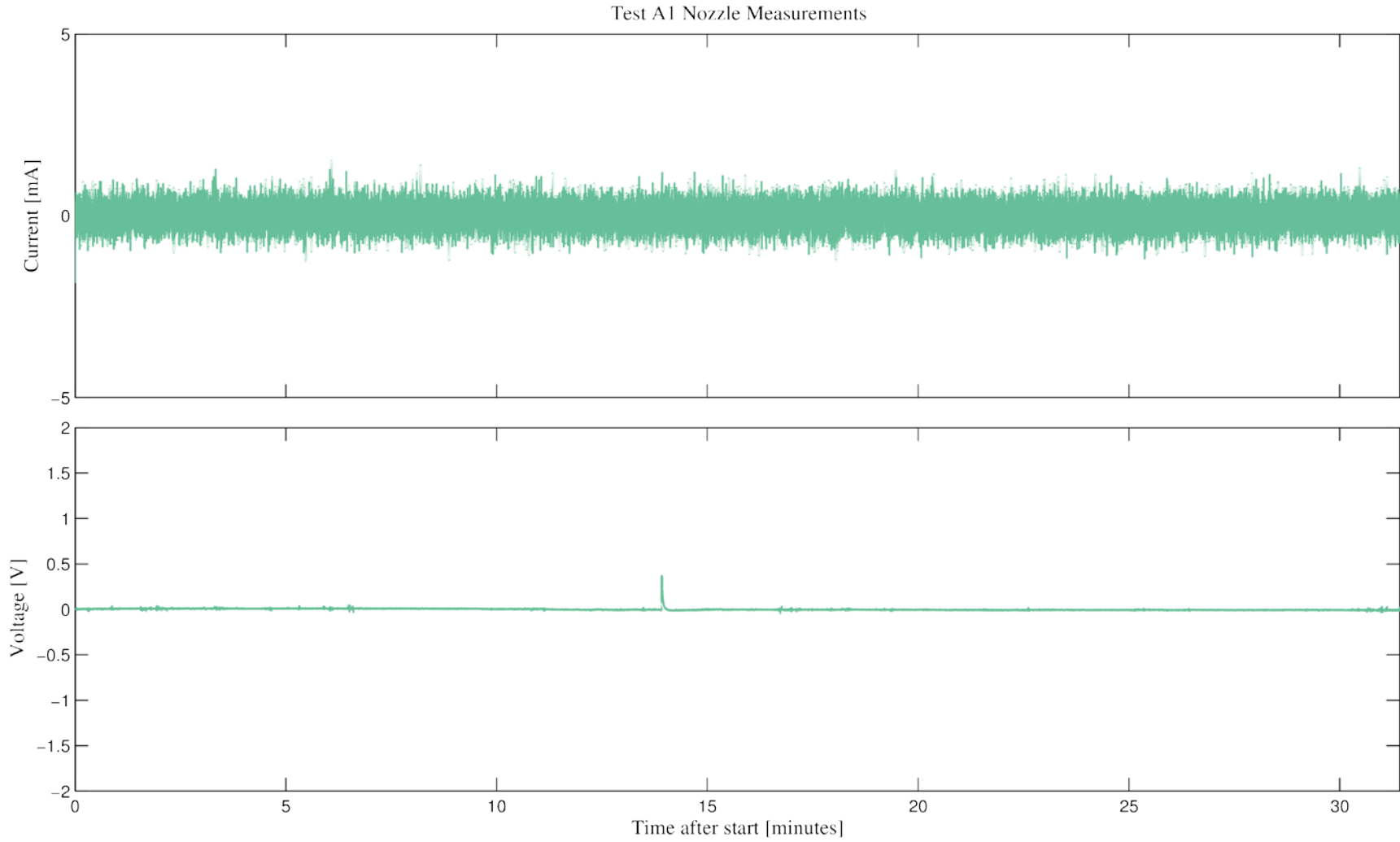

Figure E.3 Nozzle voltage and current measurements for Test A1

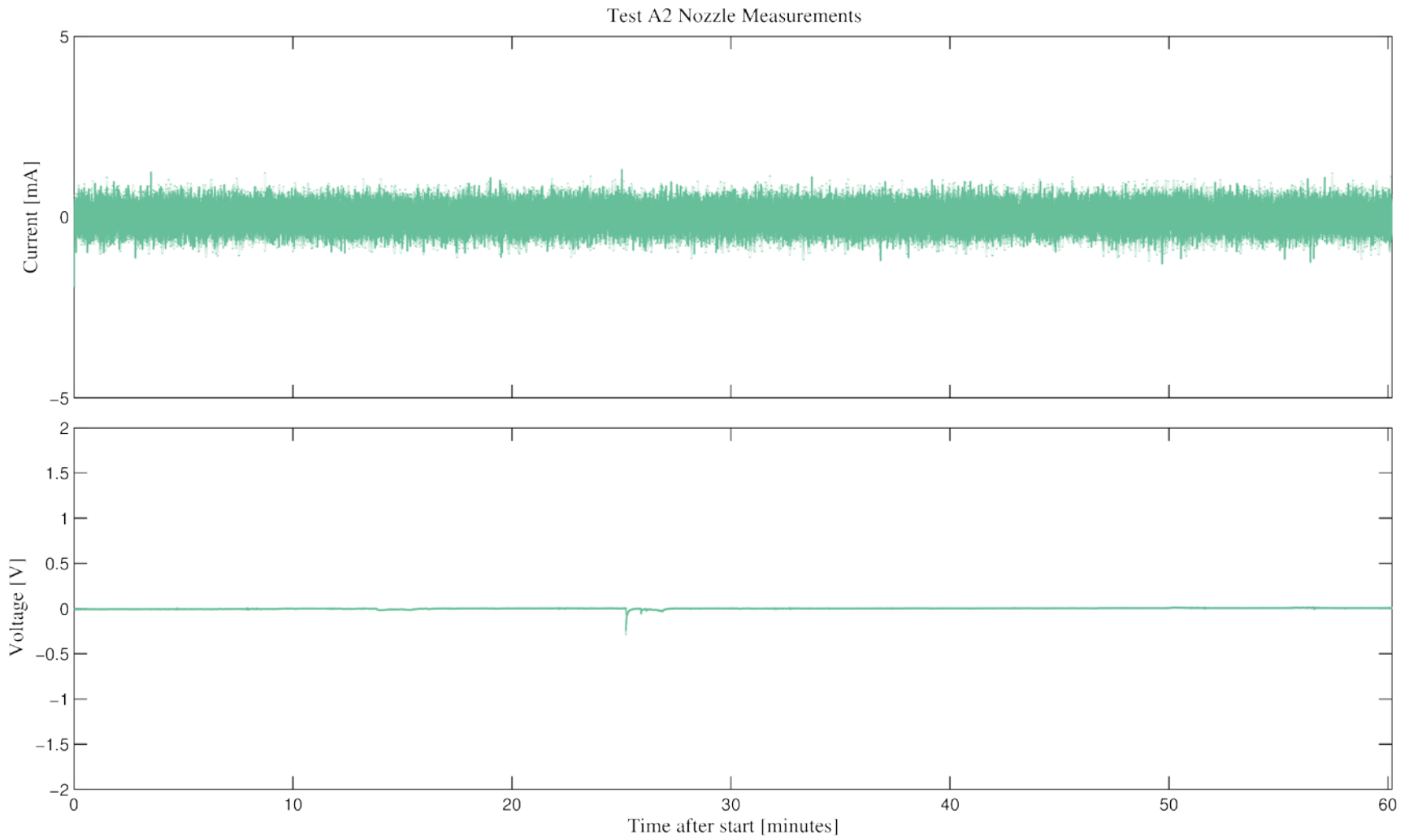

Figure E.4 Nozzle voltage and current measurements for Test A2

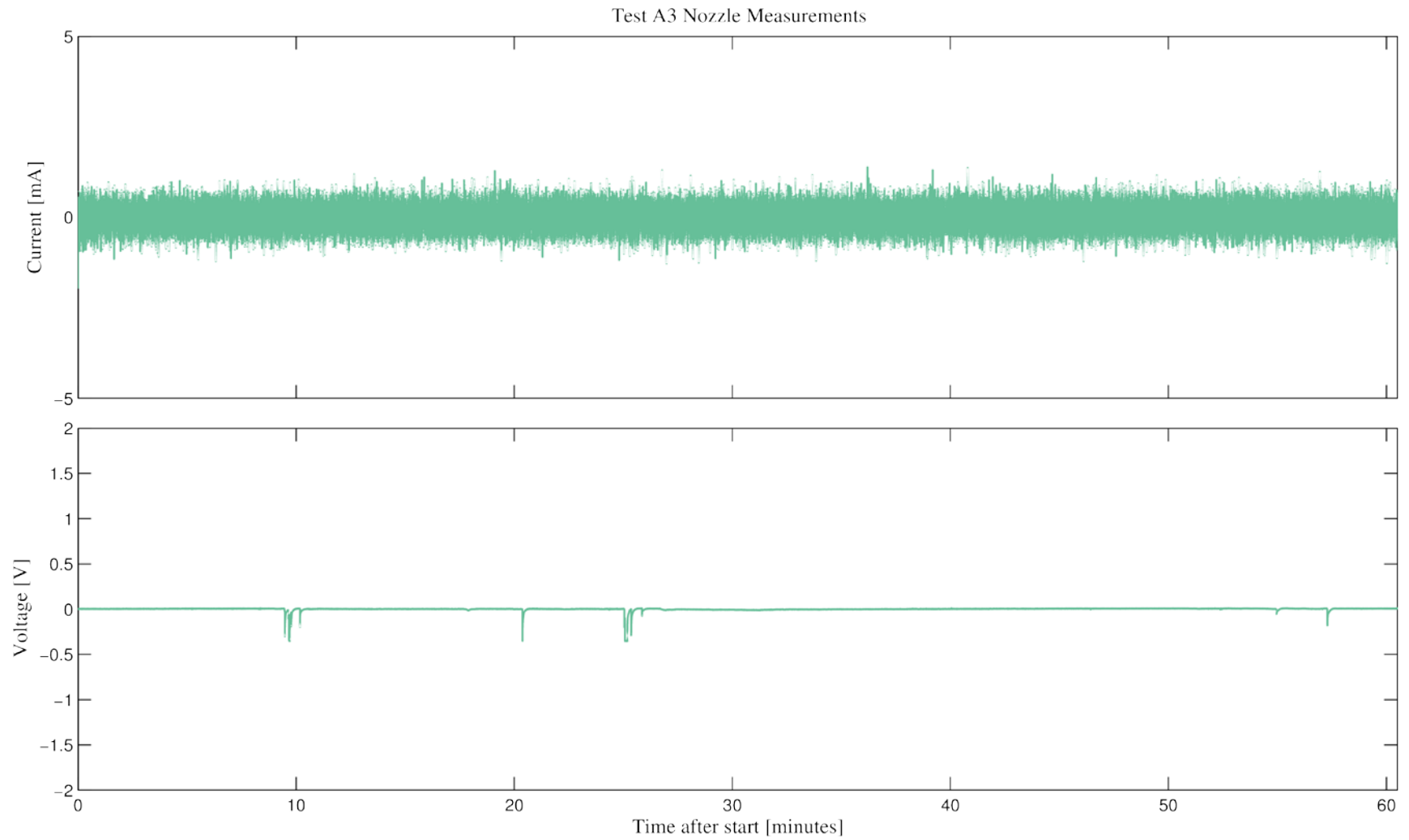

Figure E.5 Nozzle voltage and current measurements for Test A3

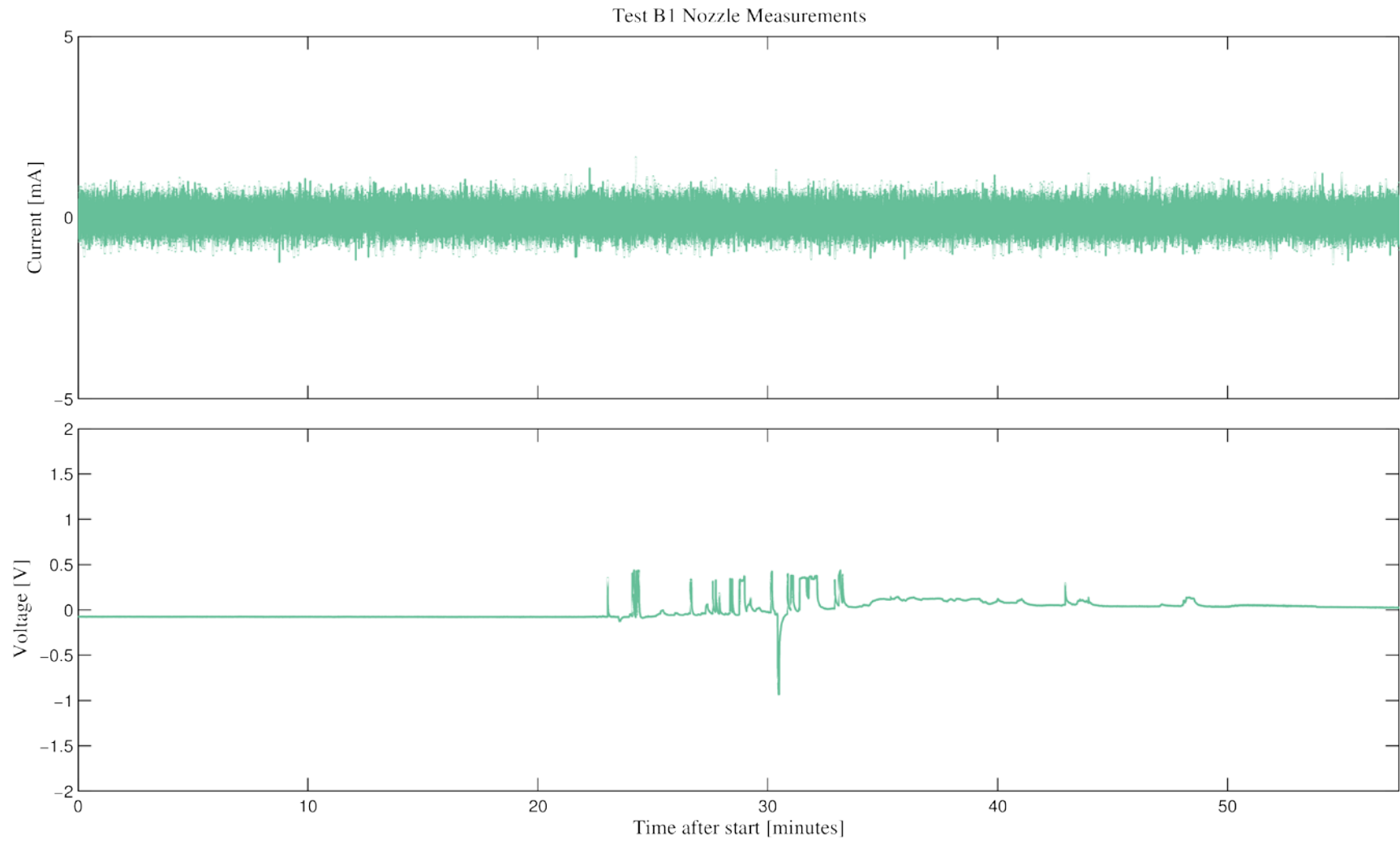

Figure E.6 Nozzle voltage and current measurements for Test B1

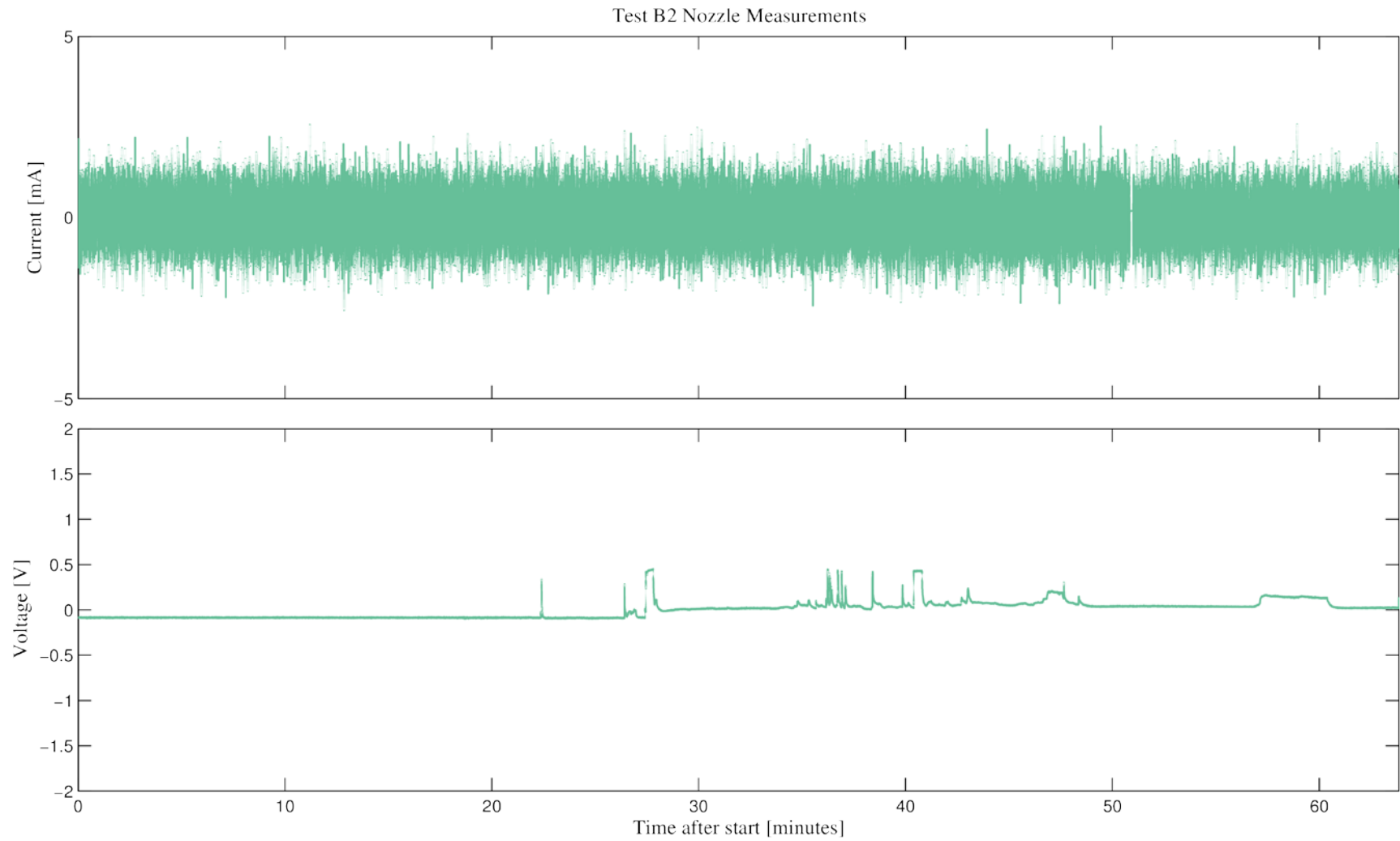

Figure E.7 Nozzle voltage and current measurements for Test B2

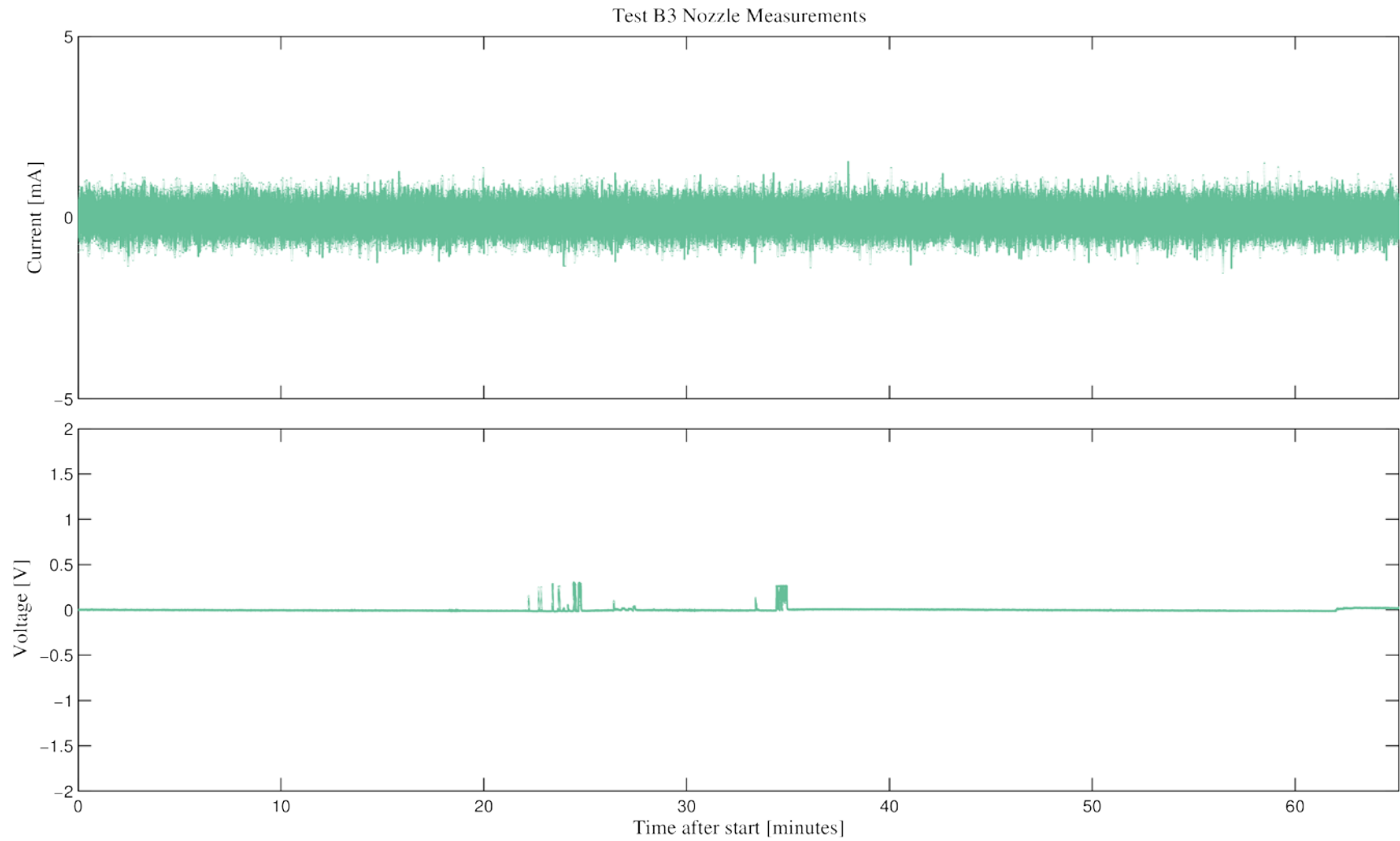

Figure E.8 Nozzle voltage and current measurements for Test B3

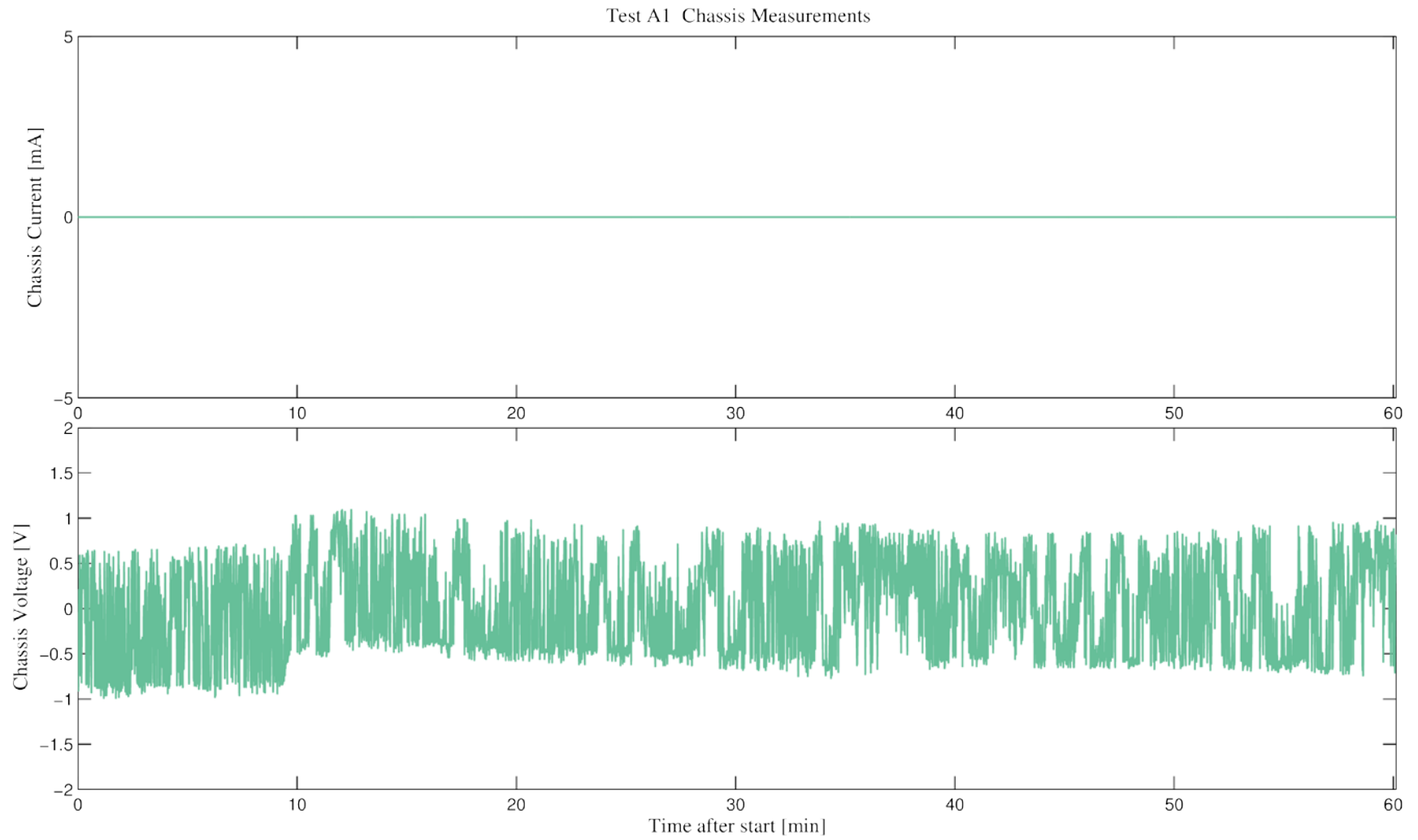

Figure E.9 Chassis voltage and current measurements for Test A1

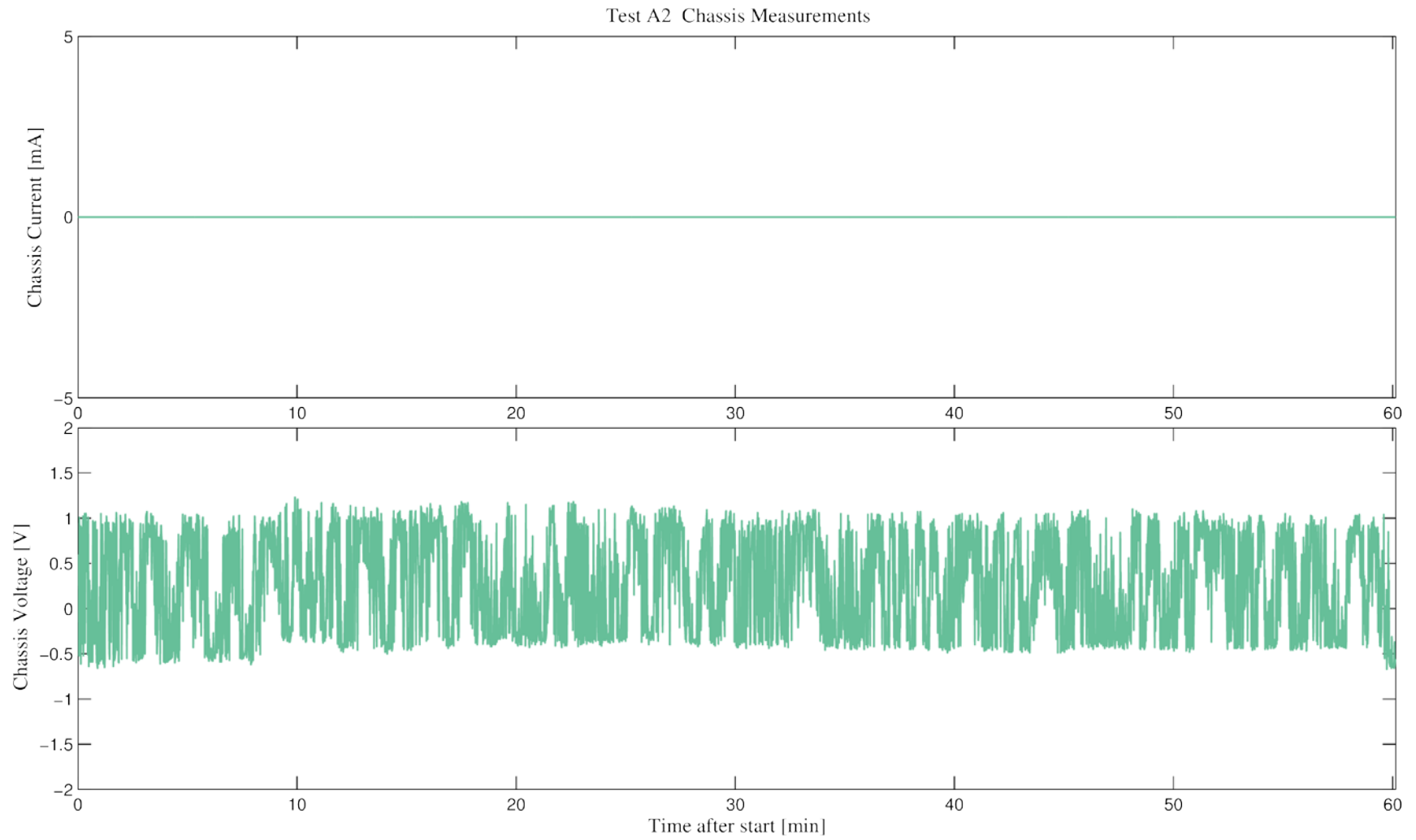

Figure E.10 Chassis voltage and current measurements for Test A2

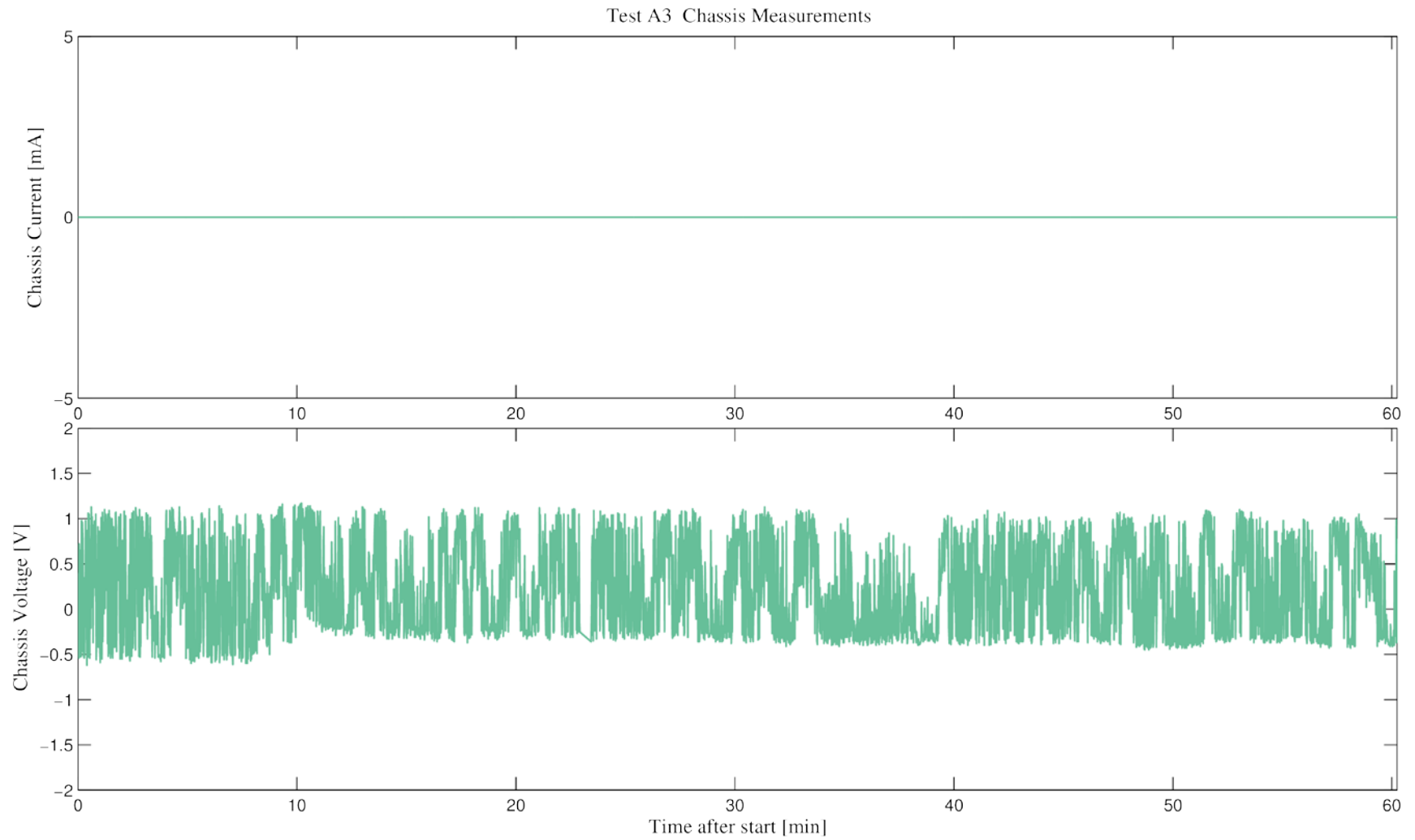

Figure E.11 Chassis voltage and current measurements for Test A3

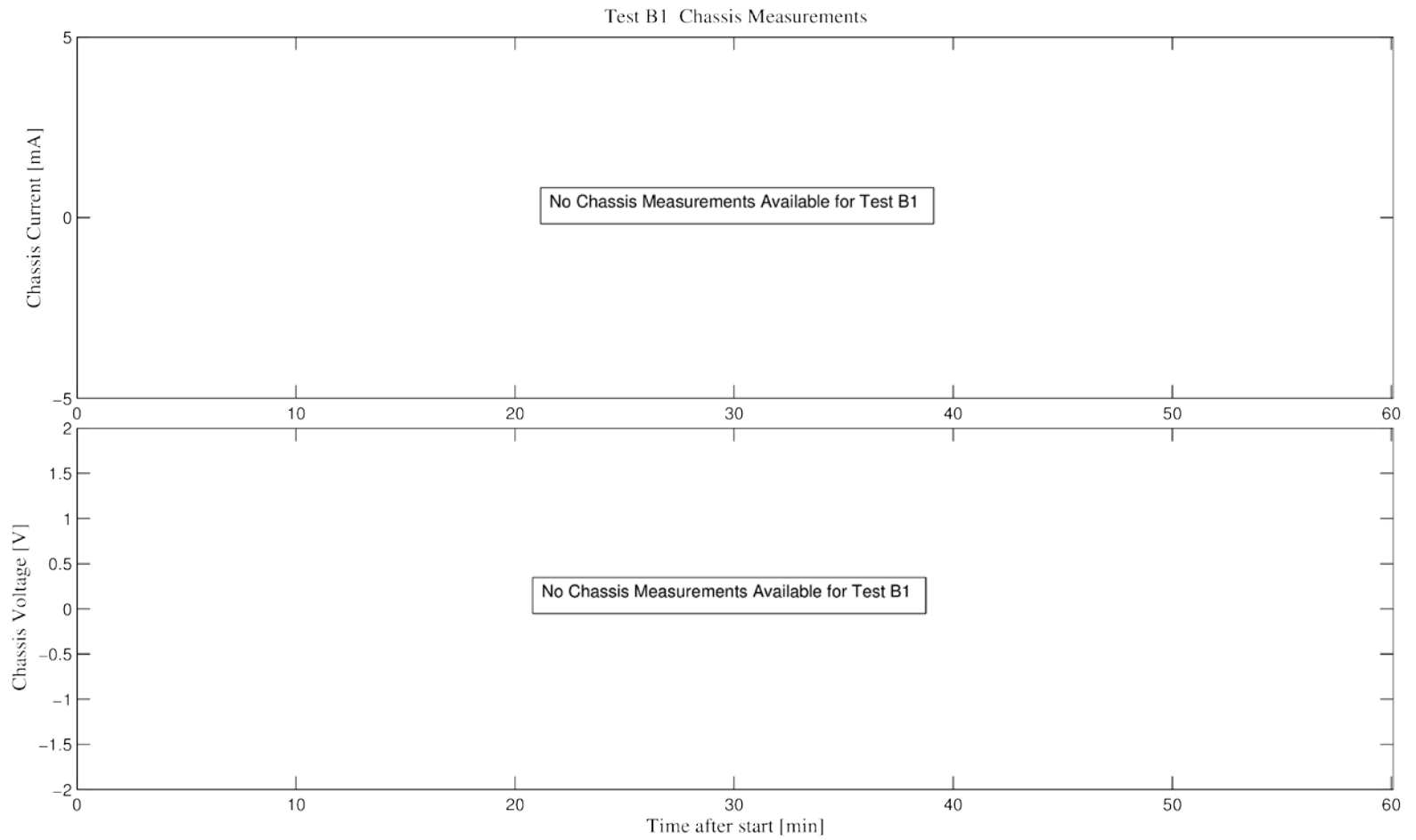

Figure E.12 Chassis voltage and current measurements for Test B1

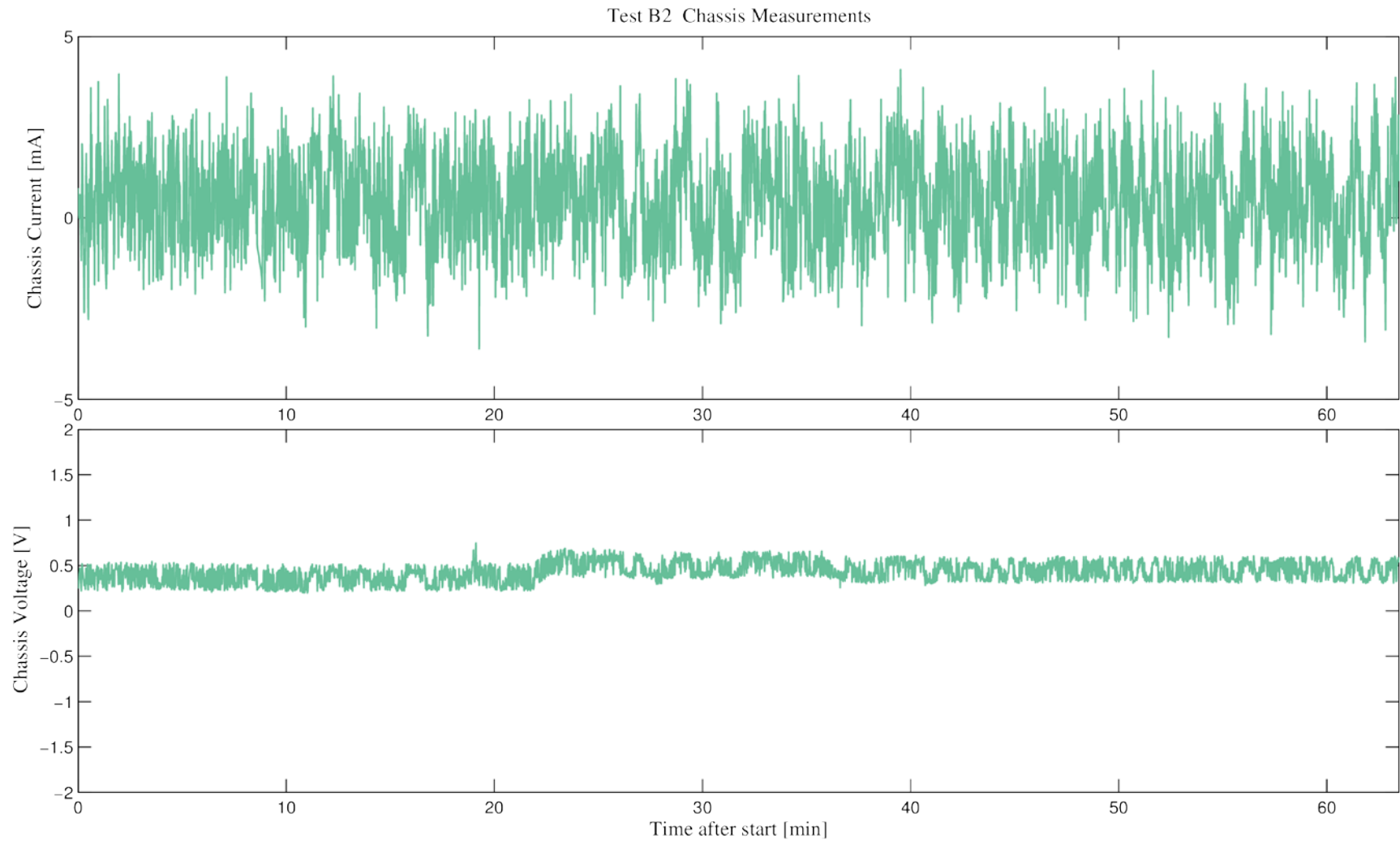

Figure E.13 Chassis voltage and current measurements for Test B2

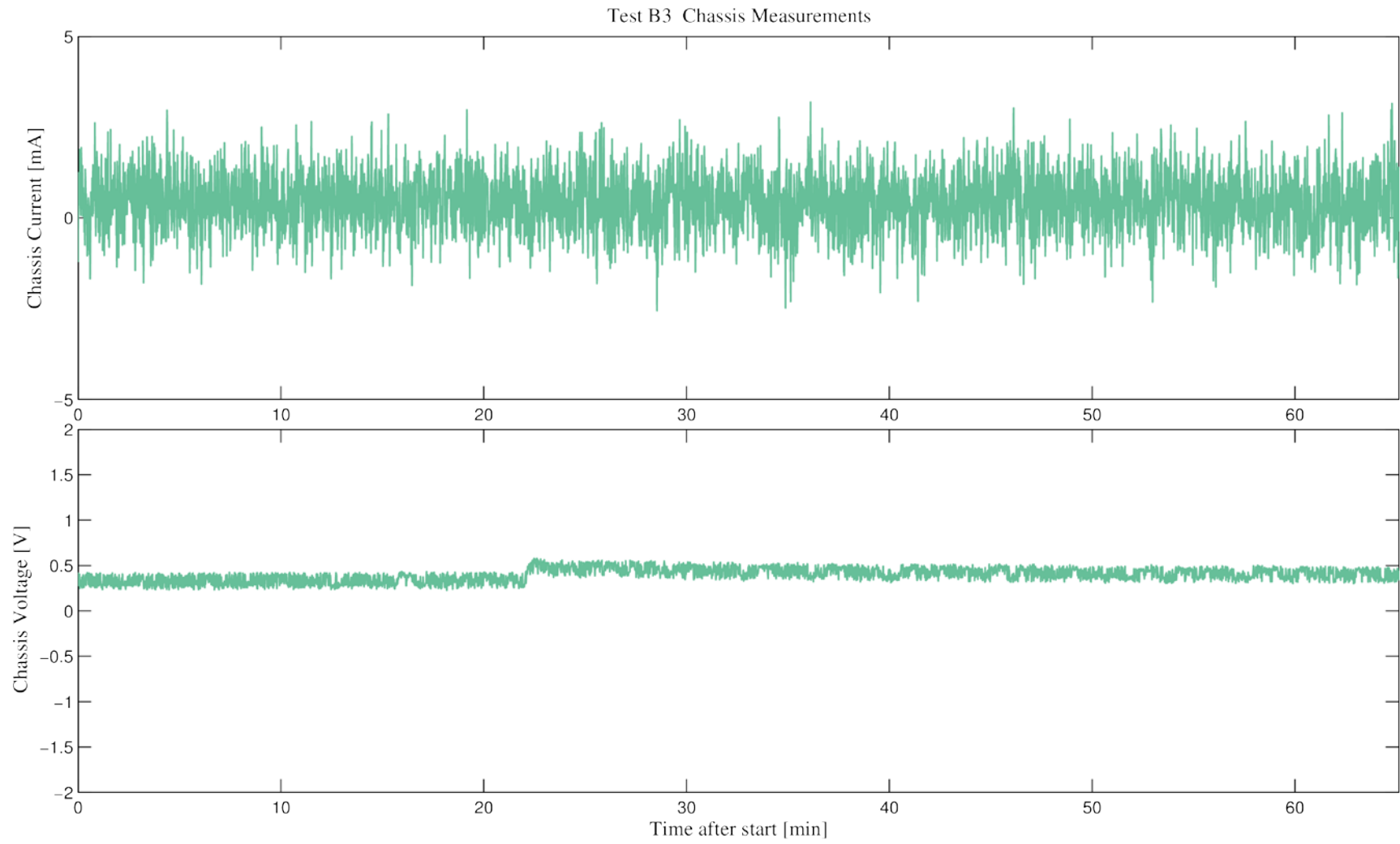

Figure E.14 Chassis voltage and current measurements for Test B3